

BDL477IV



[www.publicsignagesolutions.philips.com](http://www.publicsignagesolutions.philips.com)

EN User manual

*Cleaning and troubleshooting*

**PHILIPS**

## SAFETY AND TROUBLESHOOTING INFORMATION

### Safety precautions and maintenance



**WARNING: Use of controls, adjustments or procedures other than those specified in this documentation may result in exposure to shock, electrical hazards and/or mechanical hazards.**

Read and follow these instructions when connecting and using your display:

#### Operation:

- Keep the display out of direct sunlight and away from stoves or any other heat sources.
- Remove any object that could fall into ventilation holes or prevent proper cooling of the display's electronics.
- Do not block the ventilation holes on the cabinet.
- When positioning the display, make sure the power plug and outlet are easily accessible.
- When turning off the display by detaching the power cord, wait 6 seconds before re-attaching the power cord for normal operation.
- Ensure the use of an approved power cord provided by Philips at all times. If your power cord is missing, please contact your local service center.
- Do not subject the display to severe vibration or high impact conditions during operation.
- Do not knock or drop the display during operation or transportation.

#### Maintenance:

- To protect your display from possible damage, do not put excessive pressure on the LCD panel. When moving your display, grasp the frame to lift; do not lift the display by placing your hand or fingers on the LCD panel.
- Unplug the display if you are not going to use it for an extensive period of time.
- Unplug the display if you need to clean it with a slightly damp cloth. The screen may be wiped with a dry cloth when the power is off. However, never use organic solvent, such as, alcohol, or ammonia-based liquids to clean your display.
- To avoid the risk of shock or permanent damage to the set, do not expose the display to dust, rain, water or an excessively moist environment.
- If your display becomes wet, wipe it with dry cloth as soon as possible.
- If a foreign substance or water gets in your display, turn the power off immediately and disconnect the power cord. Then remove the foreign substance or water, and send the unit to the maintenance center.
- Do not store or use the display in locations exposed to heat, direct sunlight or extreme cold.
- In order to maintain the best performance of your display and ensure a longer lifetime, we strongly recommend using the display in a location that falls within the following temperature and humidity ranges.
  - Temperature: 0 ~ 40°C 32-104°F
  - Humidity: 20-80% RH

**IMPORTANT:** Always activate a moving screen saver program when you leave your display unattended. Always activate a periodic screen refresh application if the unit will display unchanging static content. Uninterrupted display of still or static images over an extended period may cause “burn in”, also known as “after-imaging” or “ghost imaging”, on your screen. This is a well-known phenomenon in LCD panel technology. In most cases, the “burned in” or “after-imaging” or “ghost imaging” will disappear gradually over a period of time after the power has been switched off.

**WARNING:** Severe "burn-in" or "after-image" or "ghost image" symptoms will not disappear and cannot be repaired. This is also not covered under the terms of your warranty.

### Service:

- The display cover should only be opened only by qualified service personnel.
- If there is any need for repair or integration, please contact your local service center.
- Do not leave your display under direct sunlight.



If your display does not operate normally, having followed the instructions set out in this document, please contact a technician or your local service center.

### Read and follow these instructions when connecting and using your display:



- Unplug the display if you are not going to use it for an extensive period of time.
- Unplug the display if you need to clean it with a slightly damp cloth. The screen may be wiped with a dry cloth when the power is off. However, never use alcohol, solvents or ammonia-based liquids.
- Consult a service technician if the display does not operate normally after having followed the instructions in this manual.
- The display cover should only be opened only by qualified service personnel.
- Keep the display out of direct sunlight and away from stoves or any other heat sources.
- Remove any object that could fall into the vents or prevent proper cooling of the display's electronics.
- Do not block the ventilation holes on the cabinet.
- Keep the display dry. To avoid electric shock, do not expose it to rain or excessive moisture.
- When turning off the display by detaching the power cable or DC power cord, wait for 6 seconds before re-attaching the power cable or DC power cord for normal operation.
- To avoid the risk of shock or permanent damage to the set do not expose the display to rain or excessive moisture.
- When installing the display, make sure the power plug and outlet are easily accessible.
- **IMPORTANT:** Always activate a screen saver program during your application. If a still image in high contrast remains on the screen for an extended period of time, it may leave an “after-image” or “ghost image” on the front of the screen. This is a well-known phenomenon that is caused by the shortcomings inherent in the LCD technology. In most cases the afterimage will disappear gradually over a period of time after the power has been switched off. Be aware that after-image symptoms cannot be repaired and are not covered under warranty.

## REGULATORY INFORMATION

### CE DECLARATION OF CONFORMITY

MMD declares under our responsibility that the product is in conformity with the following standards

- EN60950-1:2006+A11:2009 (Safety requirement of Information Technology Equipment)
- EN55022:2006+A1:2007 (Radio Disturbance requirement of Information Technology Equipment)
- EN55024:1998+A1:2001+A2:2003 (Immunity requirement of Information Technology Equipment)
- EN61000-3-2:2006 (Limits for Harmonic Current Emission)
- EN61000-3-3:1995+A1:2001+A2:2005 (Limitation of Voltage Fluctuation and Flicker)
- EN55013:2001+A1:2003 +A2:2006 (Limits and Methods of Measurement of Radio Disturbance Characteristics of Broadcast Receivers and Associated Equipment)
- EN55020:2007 (Electromagnetic Immunity of Broadcast Receivers and Associated Equipment)

following provisions of directives applicable

- 2006/95/EC (Low Voltage Directive)
- 2004/108/EC (EMC Directive)
- 93/68/EEC (Amendment of EMC and Low Voltage Directive) and is produced by a manufacturing organization on ISO9000 level.

### FEDERAL COMMUNICATIONS COMMISSION (FCC) NOTICE (U.S. Only)



This equipment has been tested and found to comply with the limits for a Class B digital device, pursuant to Part 15 of the FCC Rules. These limits are designed to provide reasonable protection against harmful interference in a residential installation. This equipment generates, uses and can radiate radio frequency energy and, if not installed and used in accordance with the instructions, may cause harmful interference to radio communications. However, there is no guarantee that interference will not occur in a particular installation. If this equipment does cause harmful interference to radio or television reception, which can be determined by turning the equipment off and on, the user is encouraged to try to correct the interference by one or more of the following measures:

- Reorient or relocate the receiving antenna.
- Increase the separation between the equipment and receiver.
- Connect the equipment into an outlet on a circuit different from that to which the receiver is connected.
- Consult the dealer or an experienced radio/TV technician for help.



Changes or modifications not expressly approved by the party responsible for compliance could void the users' authority to operate the equipment.

Use only RF shielded cable that was supplied with the display when connecting this unit to a computer device. To prevent damage which may result in fire or shock hazard, do not expose this appliance to rain or excessive moisture.

THIS CLASS B DIGITAL APPARATUS MEETS ALL REQUIREMENTS OF THE CANADIAN INTERFERENCE-CAUSING EQUIPMENT REGULATIONS.

### FCC DECLARATION OF CONFORMITY

Trade Name: Philips



Declaration of Conformity for Products Marked with FCC Logo, United States Only: This device complies with Part 15 of FCC Rules. Operation is subject to the following two conditions: (1) this device may not cause harmful interference, and (2) this device must accept any interference received, including interference that may cause undesired operation.

## **POLISH CENTER FOR TESTING AND CERTIFICATION NOTICE**

The equipment should draw power from a socket with an attached protection circuit (a three-prong socket). All equipment that works together (computers, monitors, printers and so on) should have the same power supply source.

The phasing conductor of the room's electrical installation should have a reserve short-circuit protection device in the form of a fuse with a nominal value no larger than 16 Amperes (A).

To completely switch off the equipment, the power supply cable must be removed from the power supply socket, which should be located near the equipment and easily accessible.

A protection mark "B" confirms that the equipment is in compliance with the protection usage requirements of standards PN-93/T-42107 and PN-89/E-06251.

### ***Wymagania Polskiego Centrum Badań i Certyfikacji***

Urządzenie powinno być zasilane z gniazda z przyłączonym obwodem ochronnym (gniazdo z kolkiem). Współpracujące ze sobą urządzenia (komputer, monitor, drukarka) powinny być zasilane z tego samego źródła.

Instalacja elektryczna pomieszczenia powinna zawierać w przewodzie fazowym rezerwową ochronę przed zwarciami, w postaci bezpiecznika o wartości znamionowej nie większej niż 16A (amperów).

W celu całkowitego wyłączenia urządzenia z sieci zasilania, należy wyjąć wtyczkę kabla zasilającego z gniazdka, które powinno znajdować się w pobliżu urządzenia i być łatwo dostępne.

Znak bezpieczeństwa "B" potwierdza zgodność urządzenia z wymaganiami bezpieczeństwa użytkownika zawartymi w PN-93/T-42107 i PN-89/E-06251.

### ***Pozostałe instrukcje bezpieczeństwa***

- Nie należy używać wtyczek adapterowych lub usuwać kolka obwodu ochronnego z wtyczki. Jeżeli konieczne jest użycie przedłużacza to należy użyć przedłużacza 3-żyłowego z prawidłowo połączonym przewodem ochronnym.
- System komputerowy należy zabezpieczyć przed nagłymi, chwilowymi wzrostami lub spadkami napięcia, używając eliminatora przepięć, urządzenia dopasowującego lub bezzakłóceniewego źródła zasilania.
- Należy upewnić się, aby nic nie leżało na kablach systemu komputerowego, oraz aby kable nie były umieszczone w miejscu, gdzie można byłoby na nie nadeptywać lub potykać się o nie.
- Nie należy rozlewać napojów ani innych płynów na system komputerowy.
- Nie należy wpychać żadnych przedmiotów do otworów systemu komputerowego, gdyż może to spowodować pożar lub porażenie prądem, poprzez zwarcie elementów wewnętrznych.
- System komputerowy powinien znajdować się z dala od grzejników i źródeł ciepła. Ponadto, nie należy blokować otworów wentylacyjnych. Należy unikać kładzenia luźnych papierów pod komputer oraz umieszczania komputera w ciasnym miejscu bez możliwości cyrkulacji powietrza wokół niego.

## **ELECTRIC, MAGNETIC AND ELECTROMAGNETIC FIELDS ("EMF")**

1. MMD manufactures and sells many products targeted at consumers, which, like any electronic apparatus, in general have the ability to emit and receive electromagnetic signals.
2. One of MMD's leading Business Principles is to take all necessary health and safety measures for our products, to comply with all applicable legal requirements and to stay well within the EMF standards applicable at the time of producing the products.
3. MMD is committed to developing, producing and marketing products that cause no adverse health effects.
4. MMD confirms that if its products are handled properly for their intended use, they are safe to use according to scientific evidence available today.
5. MMD plays an active role in the development of international EMF and safety standards, enabling MMD to anticipate further developments in standardization for early integration in its products.

## INFORMATION FOR UK ONLY

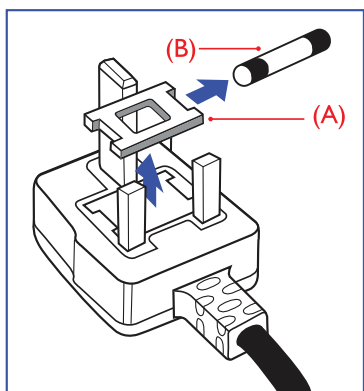

### **WARNING - THIS APPLIANCE MUST BE EARTHED.**

#### **Important:**

This apparatus is supplied with an approved moulded 13A plug. To change a fuse in this type of plug proceed as follows:

1. Remove fuse cover and fuse.
2. Fit new fuse which should be a BS 1362 5A, A.S.T.A. or BSI approved type.
3. Refit the fuse cover.

If the fitted plug is not suitable for your socket outlets, it should be cut off and an appropriate 3-pin plug fitted in its place.

If the mains plug contains a fuse, this should have a value of 5A. If a plug without a fuse is used, the fuse at the distribution board should not be greater than 5A.

Note: Any severed plug must be destroyed to avoid a possible shock hazard should it be inserted into a 13A socket elsewhere.

#### **How to connect a plug**

The wires in the mains lead are coloured in accordance with the following code:

BLUE - "NEUTRAL" ("N")

BROWN - "LIVE" ("L")

GREEN & YELLOW - "EARTH" ("E")

1. The GREEN AND YELLOW wire must be connected to the terminal in the plug which is marked with the letter "E" or by the Earth symbol or  coloured GREEN or GREEN AND YELLOW.
2. The BLUE wire must be connected to the terminal which is marked with the letter "N" or coloured BLACK.
3. The BROWN wire must be connected to the terminal which marked with the letter "L" or coloured RED.

Before replacing the plug cover, make certain that the cord grip is clamped over the sheath of the lead - not simply over the three wires.

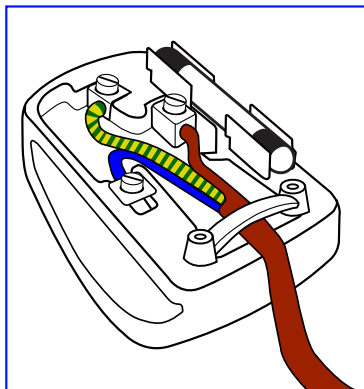

## 中国电子信息产品污染控制表示要求 ( 中国 RoHS 法规标示要求 ) 产品中有毒有害物质或元素的名称及含量

部件名称	有毒有害物质或元素					
	铅 (Pb)	汞 (Hg)	镉 (Cd)	六价铬 (Cr 6 <sup>+</sup> )	多溴联苯 (PBB)	多溴二苯醚 (PBDE)
外壳	○	○	○	○	○	○
液晶面板	X	X	○	○	○	○
电路板组件	X	○	○	○	○	○
附件 ( 遥控器, 电源线, 连接线 )	X	○	○	○	○	○
遥控器电池	X	○	○	○	○	○

○: 表示该有毒有害物质在该部件所有均质材料中的含量均在 SJ/T11363-2006 标准规定的限量要求以下。

X: 表示该有毒有害物质至少在该部件的某一均质材料中的含量超出 SJ/T11363-2006 标准规定的限量要求。



### 环保使用期限

此标识指期限 ( 十年 ), 电子信息产品中含有的有毒有害物质或元素在正常使用的条件下不会发生外泄或突变, 电子信息产品用户使用该电子信息产品不会对环境造成严重污染或对其人身、财产造成严重损害的期限。

### 《废弃电器电子产品回收处理管理条例》提示性说明

为了更好地关爱及保护地球, 当用户不再需要此产品或产品寿命终止时, 请遵守国家废弃电器电子产品回收处理相关法律法规, 将其交给当地具有国家认可的回收处理资质的厂商进行回收处理。

## NORTH EUROPE (NORDIC COUNTRIES) INFORMATION

Placering/Ventilation

### **VARNING:**

FÖRSÄKRA DIG OM ATT HUVUDBRYTARE OCH UTTAG ÄR LÄTÅTKOMLIGA, NÄR DU STÄLLER DIN UTRUSTNING PÅPLATS.

Placering/Ventilation

### **ADVARSEL:**

SØRG VED PLACERINGSFOR, AT NETLEDNINGENS STIK OG STIKKONTAKT ER NEMT TILGÆNGELIGE.

Paikka/Ilmankierto

### **VAROITUS:**

SIIJOITA LAITE SITEN, ETTÄ VERKKOJOHTO VOIDAAN TARVITTAESSA HELPOSTI IRROTTAA PISTORASIESTA.

Plassering/Ventilasjon

### **ADVARSEL:**

NÅR DETTE UTSTYRET PlassERES, MÅ DU PASSE PÅ AT KONTAKTENE FOR STØMTILFØRSEL ER LETTE Å NÅ.

## END-OF-LIFE DISPOSAL

Your display contains materials that can be recycled and reused. Specialized companies can recycle your product to increase the amount of reusable materials and to minimize the amount to be disposed of.

Please find out about the local regulations on how to dispose of your old display from your local Philips dealer.

### **(For customers in Canada and U.S.A.)**

This product may contain lead and/or mercury. Dispose of in accordance to local state and federal regulations. For additional information on recycling contact [www.eia.org](http://www.eia.org) (Consumer Education Initiative)

## WASTE ELECTRICAL AND ELECTRONIC EQUIPMENT-WEEE

### **Attention users in European Union: private households**



This marking on the product or on its packaging illustrates, under European Directive 2002/96/EG governing used electrical and electronic appliances, that this product may not be disposed of with normal household waste. You are responsible for the disposal of this equipment through a designated waste electrical and electronic equipment collection. To determine the locations for dropping off such electrical and electronic waste, contact your local government office or the waste disposal organization that serves your household area.

### **Attention users in United States:**

Like all LCD products, this set contains a lamp with Mercury. Please dispose of according to all Local, State and Federal Laws. For the disposal or recycling information, contact: [www.mygreenelectronics.com](http://www.mygreenelectronics.com) or [www.eiae.org](http://www.eiae.org).



## END OF LIFE DIRECTIVES - RECYCLING

Your display contains several materials that can be recycled for new uses.

Like all LCD products, this set contains a lamp with Mercury, please dispose of according to all local State and Federal laws.



As an ENERGY STAR® Partner, MMD has determined that this product meets the ENERGY STAR® guidelines for energy efficiency.



## **TABLE OF CONTENTS**

- 1. UNPACKING AND INSTALLATION**
  - 1.1. UNPACKING**
  - 1.2. PACKAGE CONTENTS**
  - 1.3. INSTALLATION NOTES**
  - 1.4. MOUNTING THE DISPLAY**
  
- 2. PARTS AND FUNCTIONS**
  - 2.1. REAR VIEW**
  - 2.2. REAR VIEW**
  - 2.3. INPUT/OUTPUT TERMINALS**
  - 2.4. REMOTE CONTROL**
    - 2.4.1. GENERAL FUNCTIONS**
    - 2.4.2. INSERTING THE BATTERIES IN THE REMOTE CONTROL**
    - 2.4.3. OPERATING RANGE OF THE REMOTE CONTROL**
  
- 3. CONNECTIONS TO EXTERNAL EQUIPMENT**
  - 3.1. USING THE CABLE RETAINER**
  - 3.2. USING THE SWITCH COVER**
  - 3.3. CONNECTING EXTERNAL EQUIPMENT (DVD/VCR/VCD)**
    - 3.3.1. USING COMPONENT VIDEO INPUT**
    - 3.3.2. USING HDMI INPUT**
  - 3.4. CONNECTING A PC**
    - 3.4.1. USING VGA INPUT**
    - 3.4.2. USING DVI INPUT**
    - 3.4.3. USING HDMI INPUT**
    - 3.4.4. USING DISPLAYPORT INPUT**
    - 3.4.5. USING a DVI-D Out to HDMI IN connection**
  - 3.5. EXTERNAL AUDIO CONNECTION**
    - 3.5.1. CONNECTING EXTERNAL SPEAKERS**
    - 3.5.2. CONNECTING EXTERNAL AUDIO DEVICE**
  - 3.6. CONNECTING ANOTHER BDL4771V DISPLAY**
  
- 4. OSD MENU**
  - 4.1. NAVIGATING THE OSD MENU**
    - 4.1.1. NAVIGATING THE OSD MENU USING THE REMOTE CONTROL**
    - 4.1.2. NAVIGATING THE OSD MENU USING THE DISPLAY'S CONTROL BUTTONS**
  - 4.2. OSD MENU OVERVIEW**
    - 4.2.1. Picture MENU**
    - 4.2.2. Screen MENU**
    - 4.2.3. Audio MENU**
    - 4.2.4. Configuration 1 MENU**
    - 4.2.5. Configuration 2 MENU**
    - 4.2.6. Advanced option MENU**
    - 4.2.7. Firmware update MENU**
  
- 5. INPUT MODE**
  
- 6. PIXEL DEFECT POLICY**
  - 6.1. PIXELS AND SUB-PIXELS**
  - 6.2. TYPES OF PIXEL DEFECTS + DOT DEFINITION**

- 6.3. BRIGHT DOT DEFECTS**
- 6.4. DARK DOT DEFECTS**
- 6.5. PROXIMITY OF PIXEL DEFECTS**
- 6.6. PIXEL DEFECT TOLERANCES**
- 6.7. MURA**
  - 6.7.1. HOW TO SPOT MURA**
  - 6.7.2. HOW TO AVOID MURA**

**7. CLEANING AND TROUBLESHOOTING**

- 7.1. CLEANING**
- 7.2. TROUBLESHOOTING**

**8. TECHNICAL SPECIFICATIONS**

2012 © Koninklijke Philips Electronics N.V. All rights reserved.

Philips and the Philips Shield Emblem are registered trade marks of Koninklijke Philips Electronics N.V. and are used under license from Koninklijke Philips Electronics N.V.

Specifications are subject to change without notice.

## I. UNPACKING AND INSTALLATION

### I.1. UNPACKING

- This product is packed in a carton, together with the standard accessories.
- All other optional accessories will be packed separately.
- Due to the size and weight of this display it is recommended for two people to move it.
- Since the display panel can be both broken and scratched easily, the product should be handled with care. Never place the product with the glass faced down unless with proper protection and padding.

### I.2. PACKAGE CONTENTS

Verify that you received the following items with your package content:



1

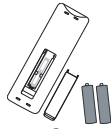

2



3



4



5



6



7



8



9

1. LCD display
2. Remote control with batteries
3. CD-ROM (EDFU and SICP)
4. Quick Start Guide
5. Cable retainer (x 3)
6. Power cord
7. VGA cable
8. BNC-to-RCA adapter (x 3)
9. Main power switch cover

- The supplied accessories will be suitable for your region, and may differ from those illustrated.
- For regions not covered by our standard power plugs, apply a power cord that conforms to the AC voltage of the power socket and has been approved by and complies with the safety regulations of the particular country.
- The package box and material can be saved for any event where the unit needs to be shipped to another location.
- External speakers and table stands are offered as optional extras, and therefore not included with your display.

### I.3. INSTALLATION NOTES

- The product should be installed on a flat surface to avoid tipping. Maintain a distance of at least 6cm between the back of the display and the wall for proper ventilation. Avoid installing the unit in a kitchen, bathroom or any other place with high humidity so as not to shorten the service life of the electronic components.
- Do not place this product on the floor and keep away from children.
- The product can normally operate only under 4000m in altitude. In installations at altitudes above 4000m, some abnormalities may be experienced.

## 1.4. MOUNTING THE DISPLAY

### Wall mounting holes

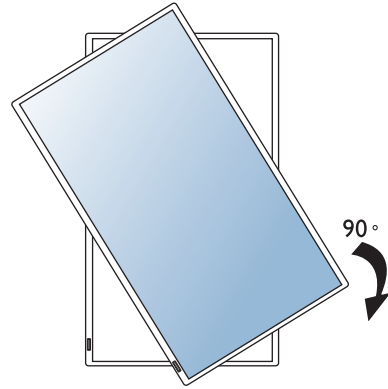
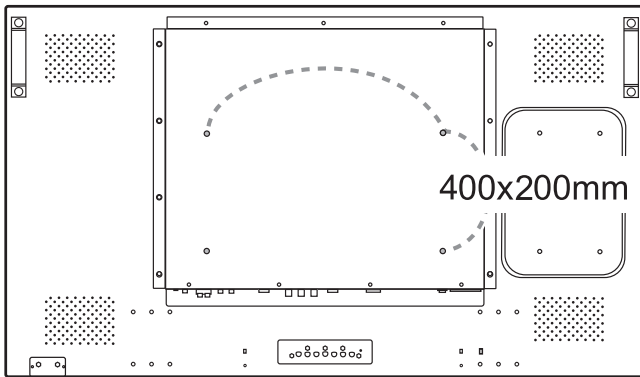

#### Notes:

- M6 (10mm) screws (with a length 10-15mm longer than the thickness of the mounting bracket) are needed for wall mounting (not included). Tighten the screws securely (recommended torque: 470 - 635N•cm)
- The mounting interface should comply with the ULI 678 standard in North America. The mounting means should be strong enough to bear the weight of the display (approx. 34 kg (75.0 lb) without stands).

Note: The AC IN/OUT socket should be on top of all connectors when rotating your display.

### Allowable tilting angle in Portrait Mode

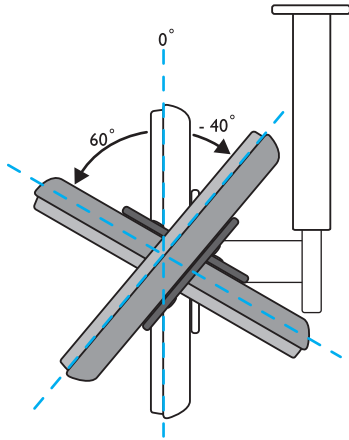

Note: When installing the display on the wall, please consult a professional technician for proper installation. The manufacturer accepts no liability for installations not performed by a professional technician.

## 2. PARTS AND FUNCTIONS

### 2.1. REAR VIEW



#### I. Remote control sensor, ambient light sensor and power indicator

- Receives command signals from the remote control.
- Detects the ambient lighting conditions around the display.
- Indicates the operating status of the unit:
  - lights green when the display is turned on
  - lights red when the display is in standby mode
  - blinks red when the display enters DPMS mode
  - off when the main power of the display is turned off

## 2.2. REAR VIEW

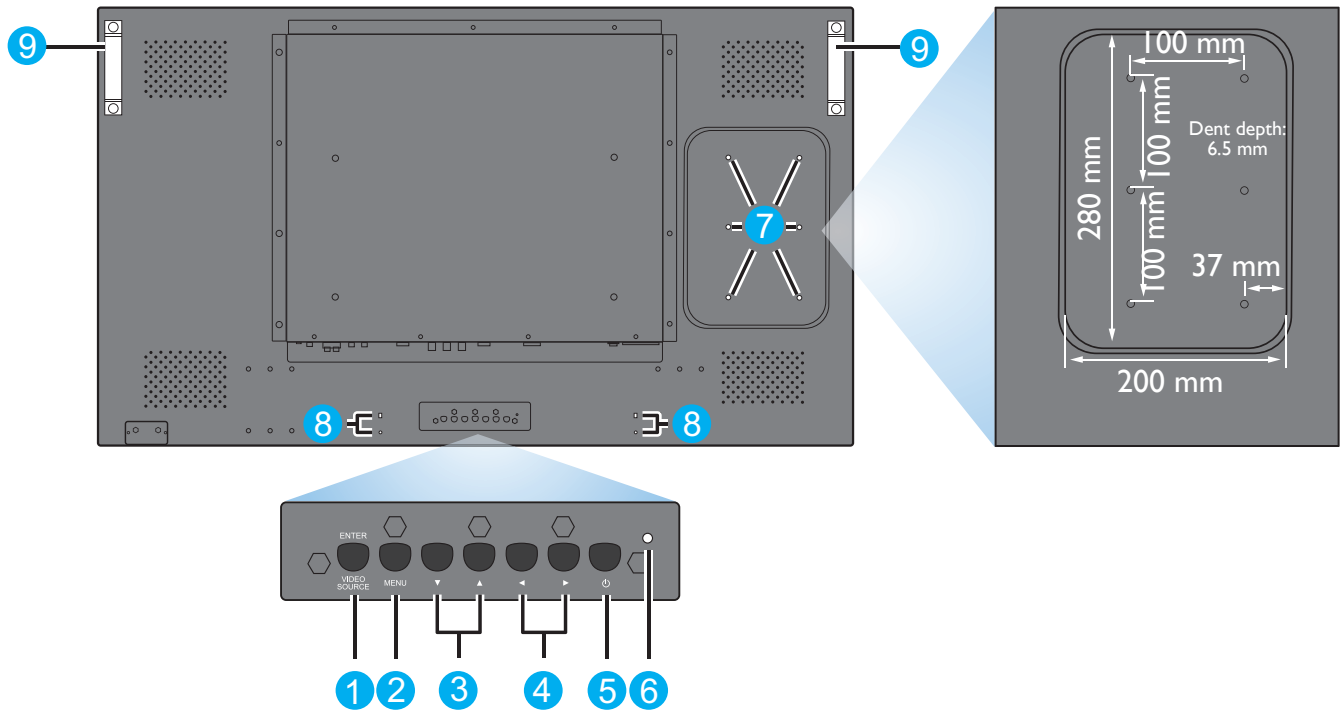

### 1. VIDEO SOURCE button

- Use this button to select the input source.
- When the On Screen Display menu is active, this is also used as the **SET** button.

### 2. MENU button

- Use this button to engage the On Screen Display menu.
- When the On Screen Display menu is active, use this button to return to the previous menu.

### 3. ▲/▼ button

- When the On Screen Display menu is active, use these as the **UP/DOWN** menu buttons.
- Press and hold the ▲ and ▼ buttons simultaneously for 3 seconds to lock or unlock all buttons.

### 4. ◀/▶ button

- When the On Screen Display menu is active, use these as the **PLUS/MINUS** menu buttons.

### 5. POWER button

Use this button to turn the display on or into standby mode.

### 6. Power indicator

Indicates the operating status of the unit:

- lights green when the display is turned on
- lights red when the display is in standby mode
- blinks red when the display enters DPMS mode
- off when the main power of the display is turned off

### 7. Smart Insert installation holes

Screw holes for the Smart Insert (for integration of a small form factor PC). (Maximum load: 2kg)

### 8. Cable retainer installation holes

Install the cable retainer using these holes.

### 9. Carrying handle

Use these handles when lifting or moving your display.

## 2.3. INPUT/OUTPUT TERMINALS

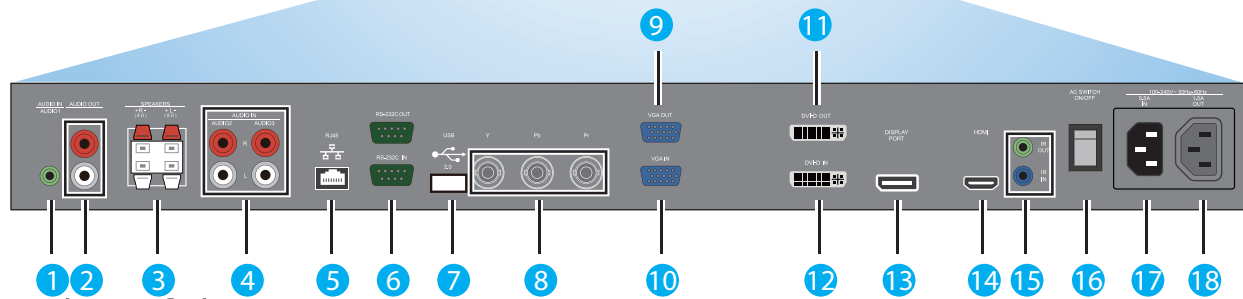
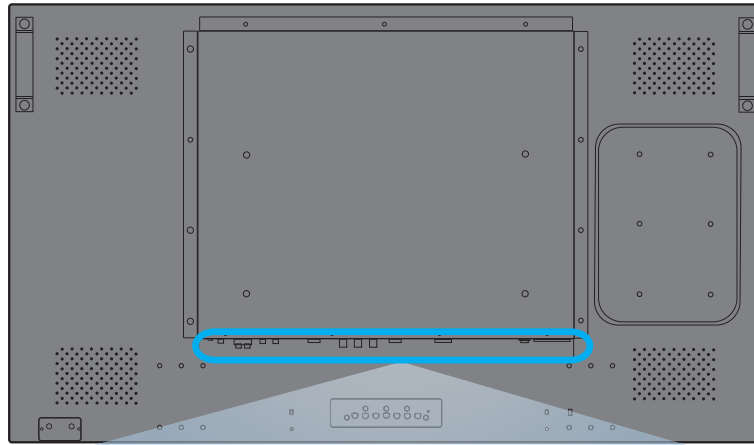

### 1. AUDIO IN (AUDIO1)

Connects to the audio output of a computer.

### 2. AUDIO OUT R/L

Outputs the audio signal from the **AUDIO IN (AUDIO1/AUDIO2/AUDIO3)**, **DISPLAYPORT** or **HDMI** jack.

### 3. SPEAKERS R/L

Outputs the audio signal from the **AUDIO IN (AUDIO1/AUDIO2/AUDIO3)**, **DISPLAYPORT** or **HDMI** jack to external speakers.

### 4. AUDIO IN (AUDIO2/AUDIO3)

Connects to the audio output of an AV device.

### 5. RJ-45

Connects to the RJ-45 port on your Ethernet network.

### 6. RS-232C (IN/OUT)

RS-232C network connection input/output for the use of loop through function.

### 7. USB

Connects to a USB flash drive (for firmware updates and display cloning only).

### 8. YPbPr

Component video input (YPbPr) for connecting to the component output of an AV device.

### 9. VGA OUT

Outputs the VGA signal from the **VGA IN** jack.

### 10. VGA IN

Connects to the VGA output of a PC or media player.

### 11. DVI-D OUT

Outputs the DVI-D signal from the **DVI-D IN** jack.

### 12. DVI-D IN

Connects to the DVI-D connector of a PC or media player or to the HDMI output of an AV device (Using a DVI-HDMI cable).

### 13. DISPLAYPORT

Connects to a DisplayPort compatible device.

### 14. HDMI

Connects to the HDMI output of an AV device or to the DVI-D output of a PC. (Using a DVI-HDMI cable/adaptor)

### 15. IR (OUT/IN)

Outputs the IR signal to a set-top box.

### 16. Main power switch

Press to switch the main power on/off.

### 17. AC IN (5.5 A)

Connects the supplied power cord to the wall outlet.

### 18. AC OUT (1.5 A)

Can be used to power an external media device.

## 2.4. REMOTE CONTROL

### 2.4.1. GENERAL FUNCTIONS

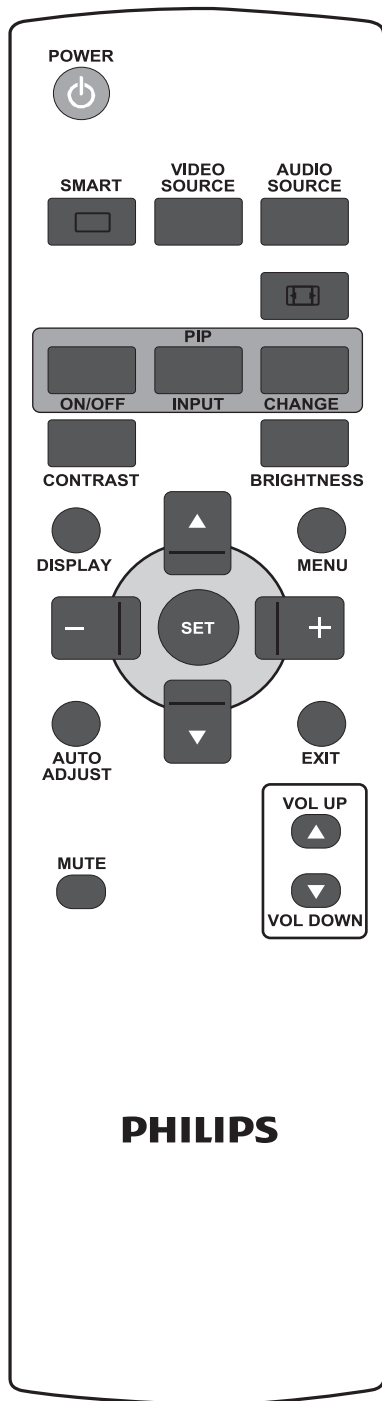

Both the IR and RF remote controls can be used for operating the display. Select **IR** or **RF** in the **Advanced > Remote control selection** menu according to the remote you wish to use.

*Note: The descriptions in this section explain the function of the IR remote control which is the standard accessory in your shipping package. The RF remote control is an optional accessory.*

**POWER**  
 **POWER button**

Press to switch on the display from standby mode. Press again to turn it to standby mode.

**SMART**  
 **SMART button**

To select smart picture mode from:

- **Highbright:** for moving images such as Video
- **Standard:** for images (factory setting)
- **sRGB:** for text based images
- **Cinema:** for movies.
- **User:** create your own picture settings. This mode is automatically selected after you change the settings in the **Picture** menu.

**VIDEO SOURCE**  
 **VIDEO SOURCE button**

Press to open the video source selection menu and then press **UP/DOWN** to select a desired video signal.

**AUDIO SOURCE**  
 **AUDIO SOURCE button**

Press to open the audio source selection menu and then press **UP/DOWN** to select a desired audio source.

 **Picture format button**

To switch screen aspect ratio between **Full**, **Normal**, **Dynamic**, **Custom**, **Real**, and **21:9**.

**PIP (Picture In Picture) buttons**

•  **ON/OFF**  
ON/OFF

•  **INPUT**  
INPUT

•  **CHANGE**  
CHANGE

*Note: These PIP functions are not available with your display.*

 **CONTRAST button**  
CONTRAST

Press to open the **Contrast** OSD selection, and then press the **PLUS** or **MINUS** button to adjust the value.



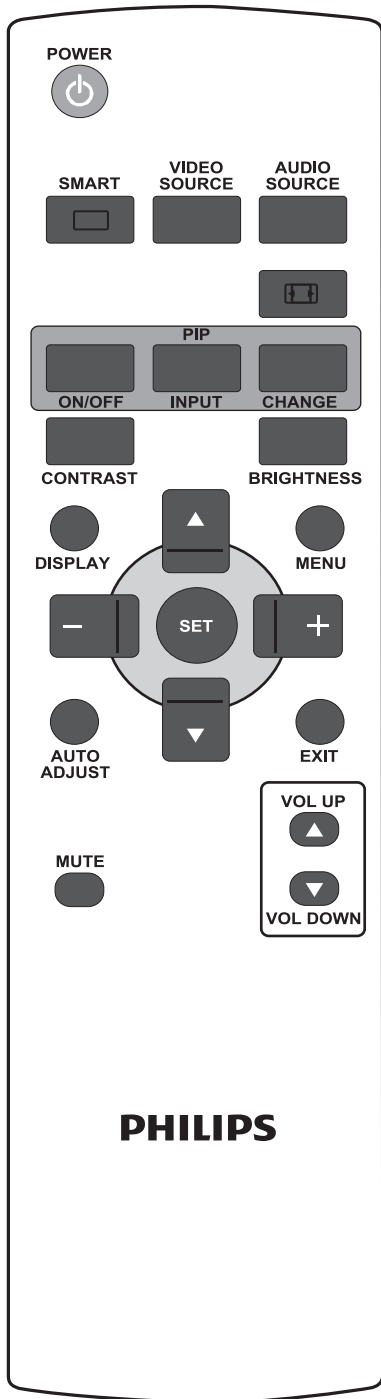

**BRIGHTNESS button**

BRIGHTNESS

Press to open the **Brightness** OSD selection, and then press the **PLUS** or **MINUS** button to adjust the value.

**DISPLAY button**

DISPLAY

To turn on/off the setting information displayed on the upper right corner of the screen.

**MENU button**

MENU

To turn the OSD menu on/off.

**UP button**

- To move the highlight bar up to adjust the selected item when OSD menu is on.
- To move the sub-picture up in “PIP” mode.

**DOWN button**

- To move the highlight bar down to adjust the selected item when OSD menu is on.
- To move the sub-picture down in “PIP” mode.

**PLUS button**

- To increase the adjustment within the OSD menu.
- To move the sub-picture right in “PIP” mode.

**MINUS button**

- To decrease the adjustment within the OSD menu.
- To move the sub-picture left in “PIP” mode.

**SET button**

To activate the changed settings inside the OSD menu.

**AUTO ADJUST button**

AUTO ADJUST

*Note: For VGA input only.*

To execute the **Auto adjust** function.

**EXIT button**

EXIT

To return to the previous OSD menu.

**MUTE button**

MUTE

To turn the mute function on/off.

**VOL UP button**

VOL UP

To increase the audio output level.

**VOL DOWN button**

VOL DOWN

To decrease the audio output level.

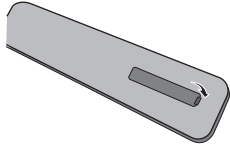
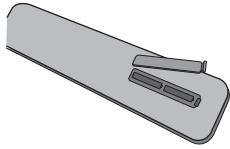
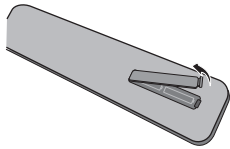

### 2.4.2. INSERTING THE BATTERIES IN THE REMOTE CONTROL

1. Remove the cover on the rear of the remote control.
2. Insert two AAA size 1.5V batteries ensuring that the “+” and “-” ends of the batteries are correctly aligned.
3. Replace the cover.

Notes:

- Do not mix battery types, e.g. alkaline and manganese.
- It is not recommended to use rechargeable batteries.

### 2.4.3. OPERATING RANGE OF THE REMOTE CONTROL

When pressing a remote control button, point the front of the remote control towards the remote control sensor.

Use the remote control within a maximum distance of about 10 m/32.8 ft perpendicular to the display's remote control sensor and within a maximum angle of 45 degrees.

Maximum distance:  
10 m/32.8 ft

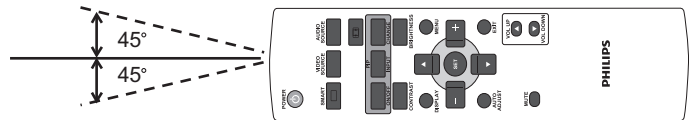

Note:

- The remote control may not function properly if the remote control sensor on the display is under direct sunlight, in a location with strong illumination, or if there is an obstacle in the path of the signal transmission.

### 3. CONNECTIONS TO EXTERNAL EQUIPMENT

#### 3.1. USING THE CABLE RETAINER

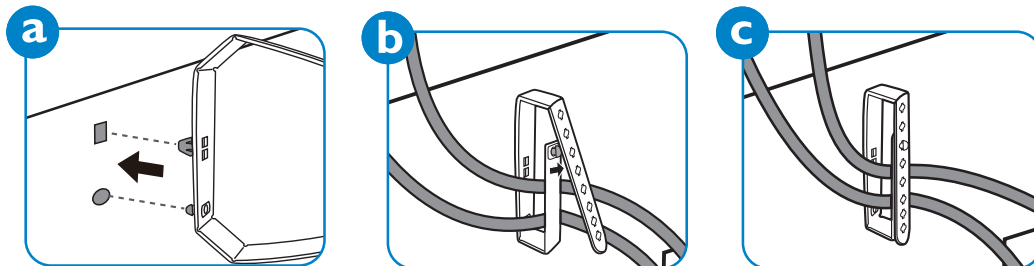

#### 3.2. USING THE SWITCH COVER

You can use the switch cover to prevent the monitor from being turned on or off accidentally.

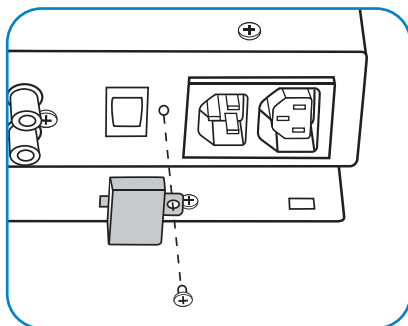

#### 3.3. CONNECTING EXTERNAL EQUIPMENT (DVD/VCR/VCD)

##### 3.3.1. USING COMPONENT VIDEO INPUT

1. Connect the BNC jacks of the device to the BNC jacks (YPbPr) of the display.
2. Connect the red (R) and white (L) audio jacks of the device to the AUDIO IN (AUDIO2 or AUDIO3) jacks of the display.

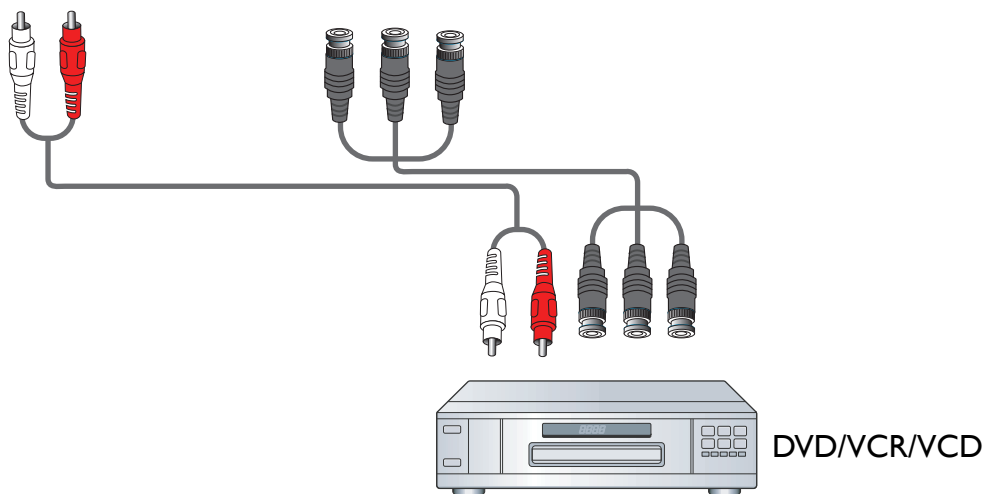
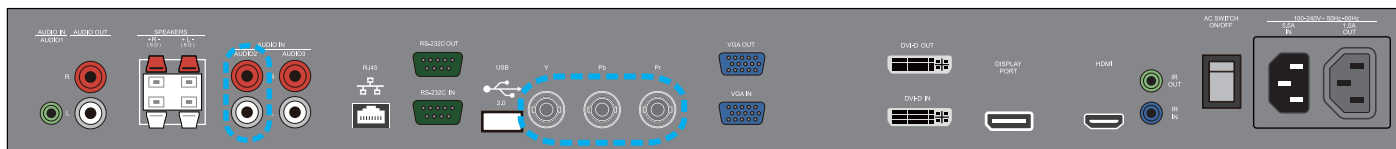

### 3.3.2. USING HDMI INPUT

Connect the HDMI connector of the external device to the HDMI input of the display.

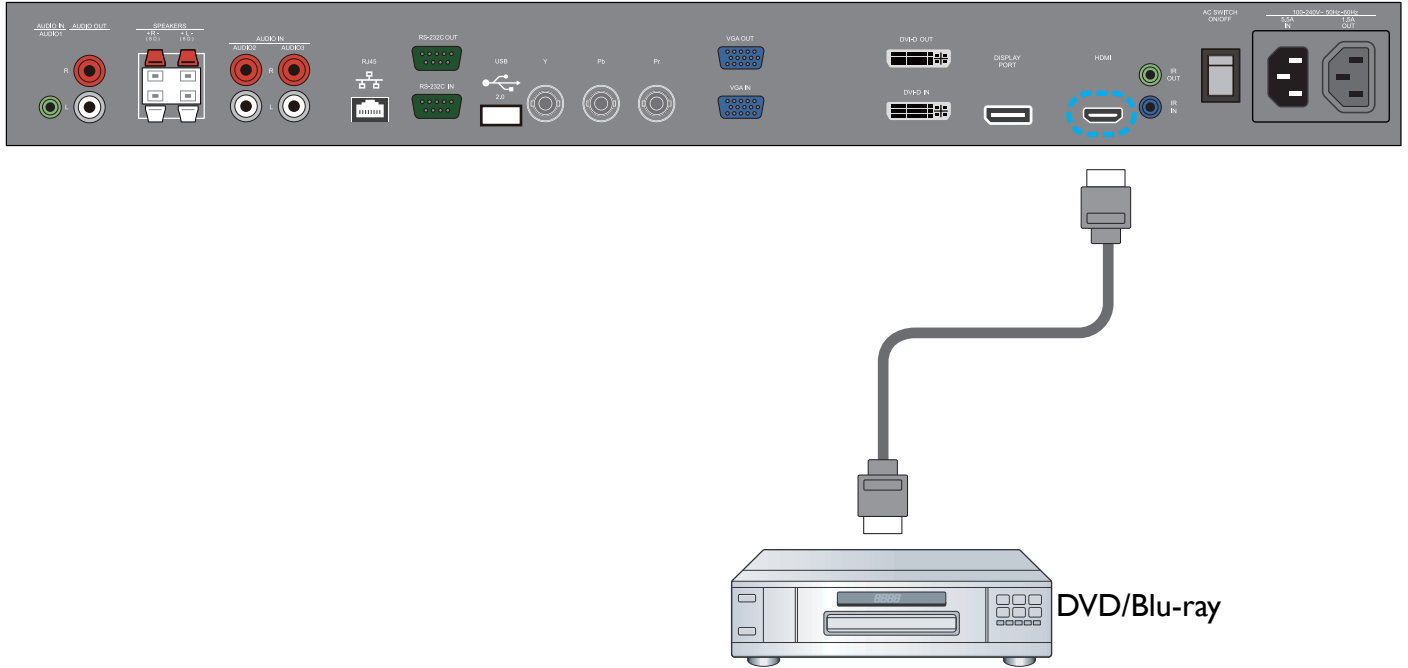

### 3.4. CONNECTING A PC

#### 3.4.1. USING VGA INPUT

1. Connect the 15-pin VGA connector of the PC to the VGA IN connector of the display.
2. Insert the audio cable to the AUDIO IN (AUDIO I) input of the display and connect to the corresponding PC connector.

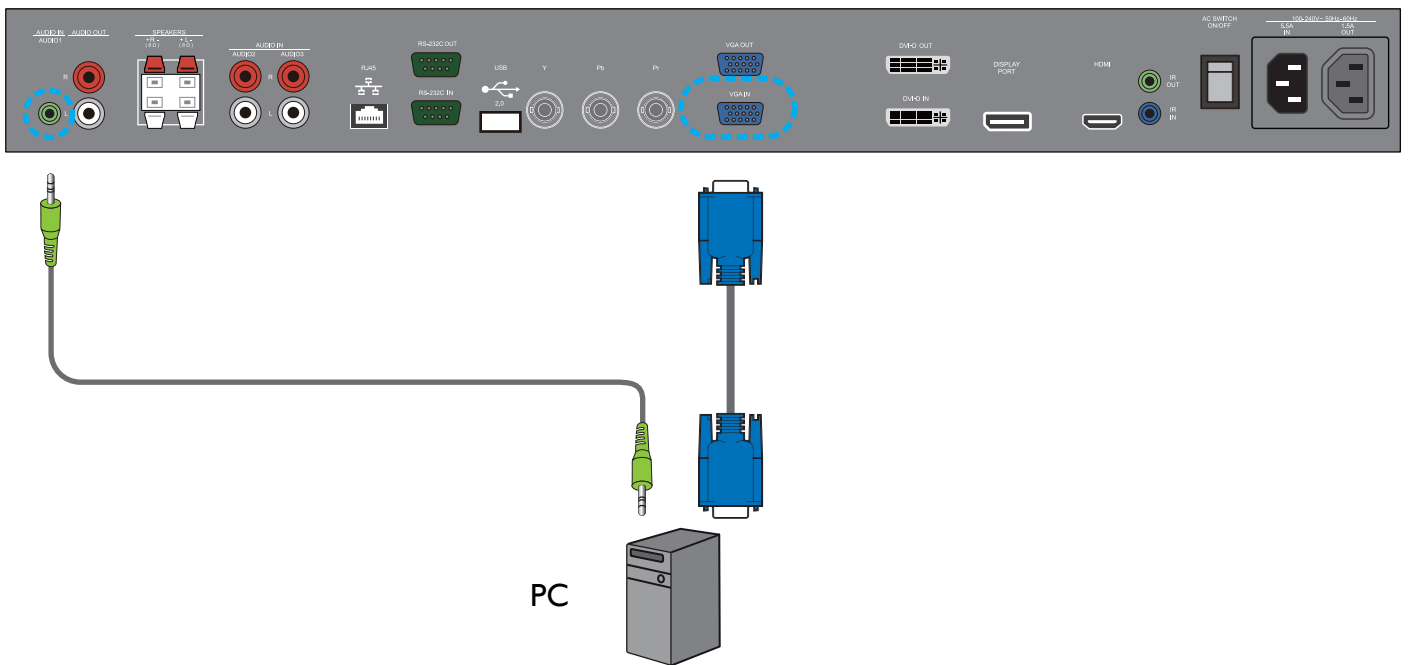

### 3.4.2. USING DVI INPUT

1. Connect the DVI-D connector of your PC or media player to the DVI-D connector of the display.
2. Insert the audio cable to the AUDIO IN (AUDIO I) input of the display and connect to the corresponding PC connector.

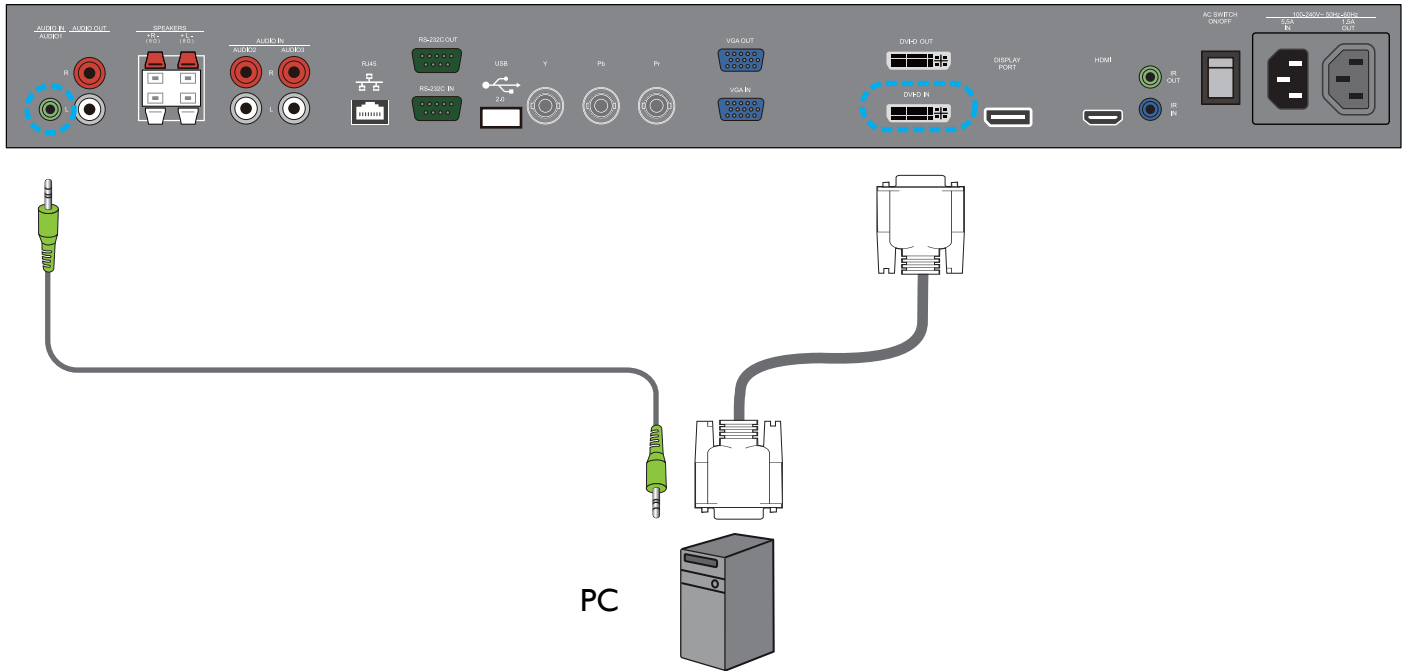

### 3.4.3. USING HDMI INPUT

1. Connect the HDMI connector of the PC to the HDMI connector of the display using an HDMI cable.

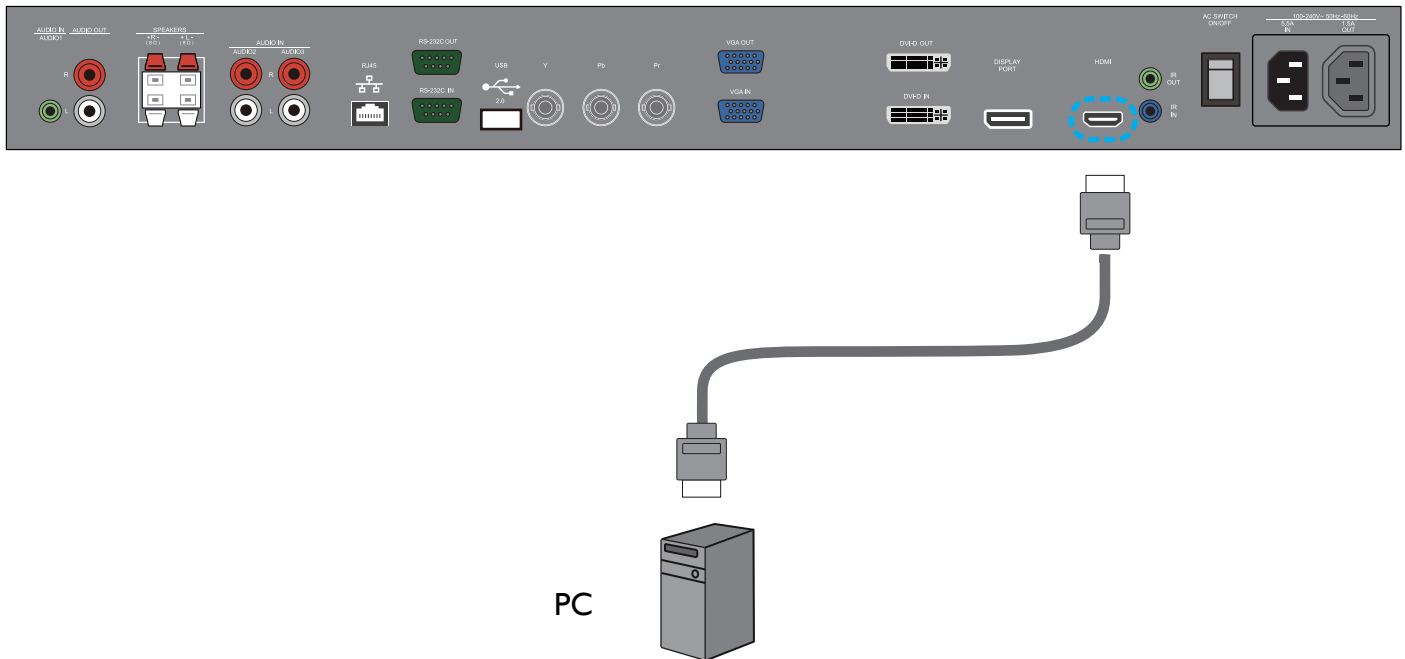

### 3.4.4. USING DISPLAYPORT INPUT

1. Connect the DisplayPort/DVI/VGA/HDMI connector of the PC to the DISPLAYPORT connector of the display using a DisplayPort to DisplayPort cable or DisplayPort to DVI/VGA/HDMI adaptor.
2. Insert the audio cable to the AUDIO IN (AUDIO I) input of the display and connect to the corresponding PC connector.

Note: The audio cable connection is not necessary if you are using the DisplayPort to DisplayPort cable or DisplayPort to HDMI adaptor..

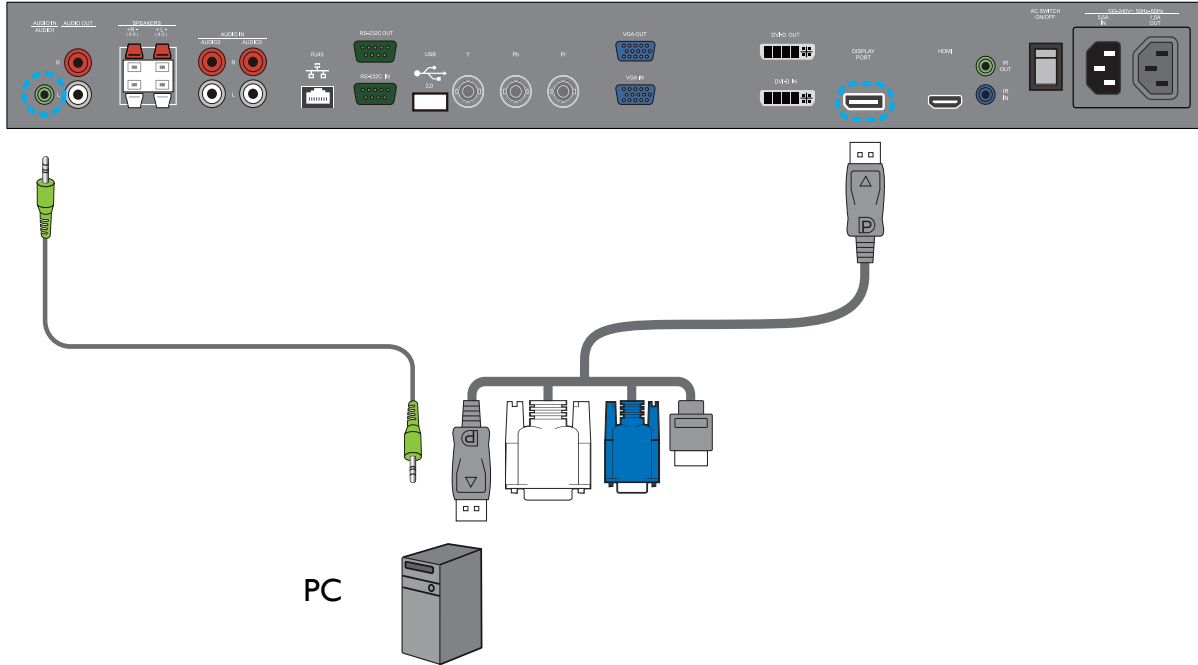

### 3.4.5. USING a DVI-D Out to HDMI IN connection

1. Connect the DVI connector of the PC to the HDMI connector of the display using a DVI-HDMI cable.
2. Insert the audio cable to the AUDIO IN (AUDIO1) input of the display and connect to the corresponding PC connector.

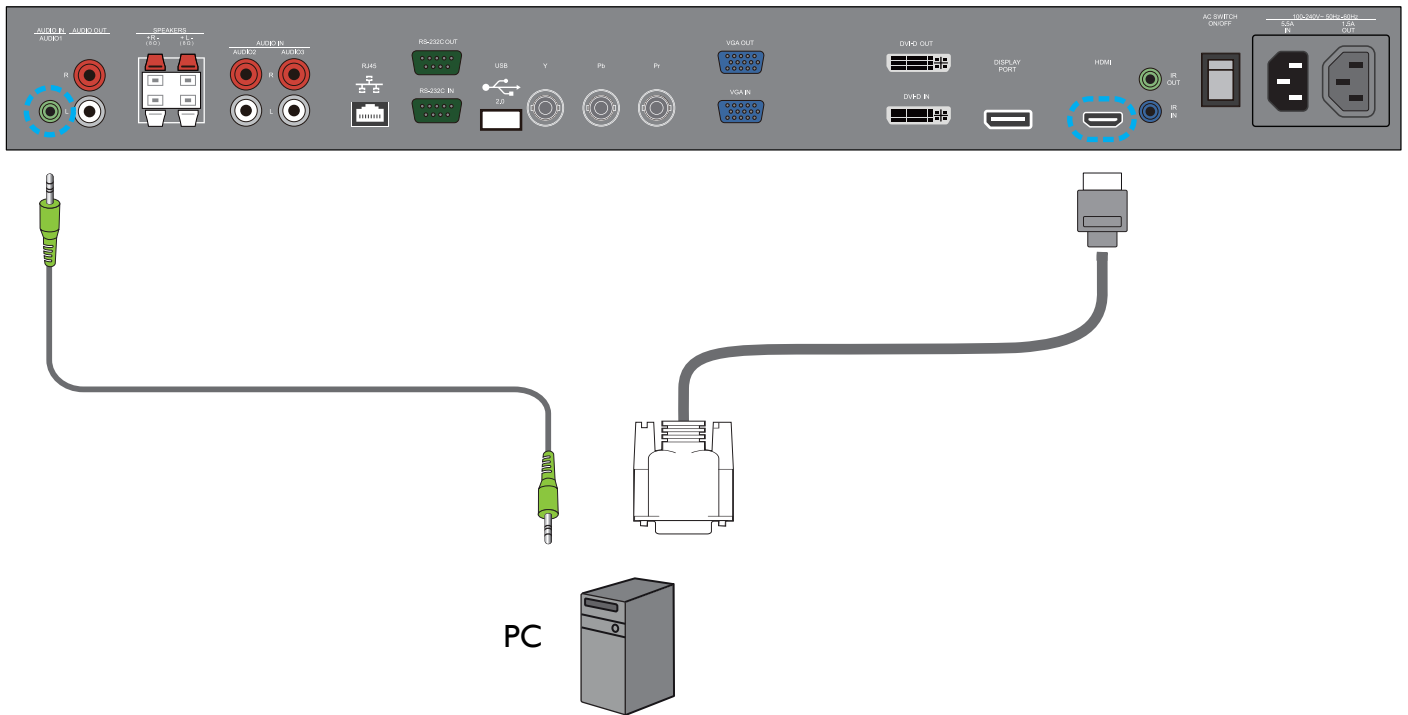

### 3.5. EXTERNAL AUDIO CONNECTION

#### 3.5.1. CONNECTING EXTERNAL SPEAKERS

1. Connect the speaker wires to the external speaker (SPEAKERS) output of the display.
2. Turn on the unit.

*Note: Make sure your display is turned off before connecting the speaker wires.*

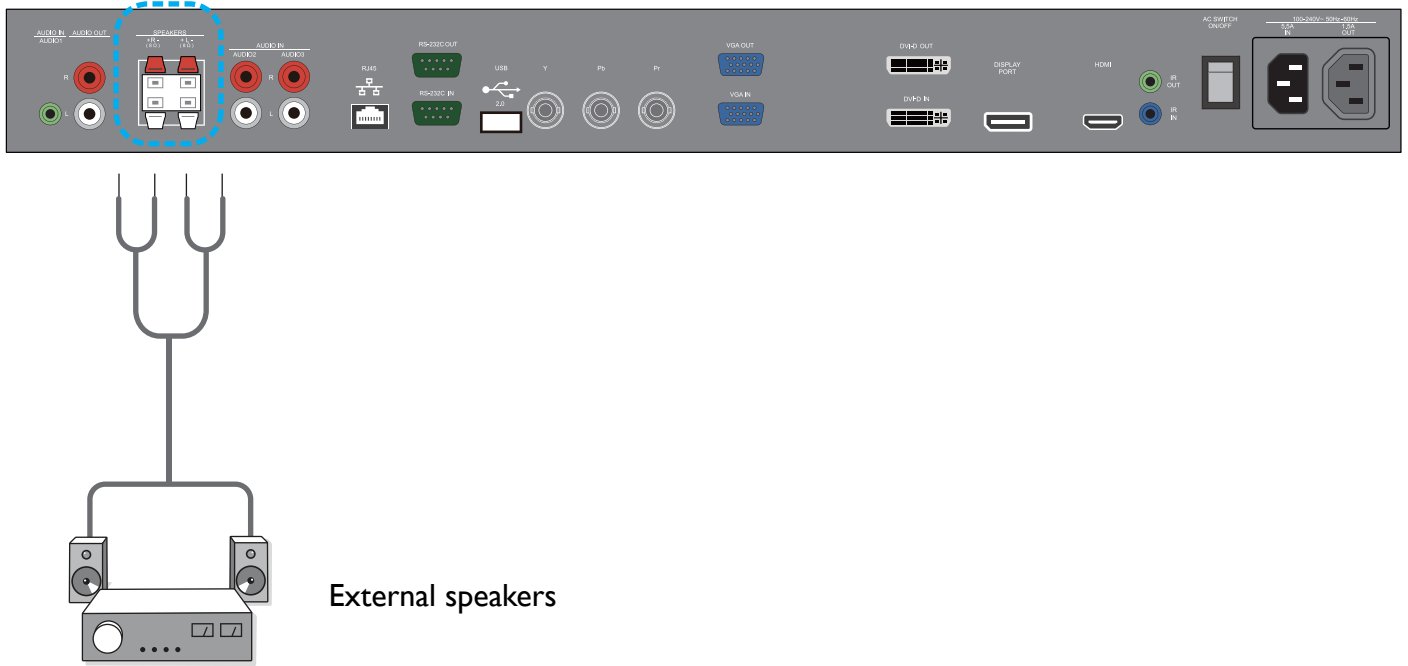

#### 3.5.2. CONNECTING EXTERNAL AUDIO DEVICE

Connect the red (R) and white (L) audio jacks of the external audio device to the AUDIO OUT R/L jacks of the display.

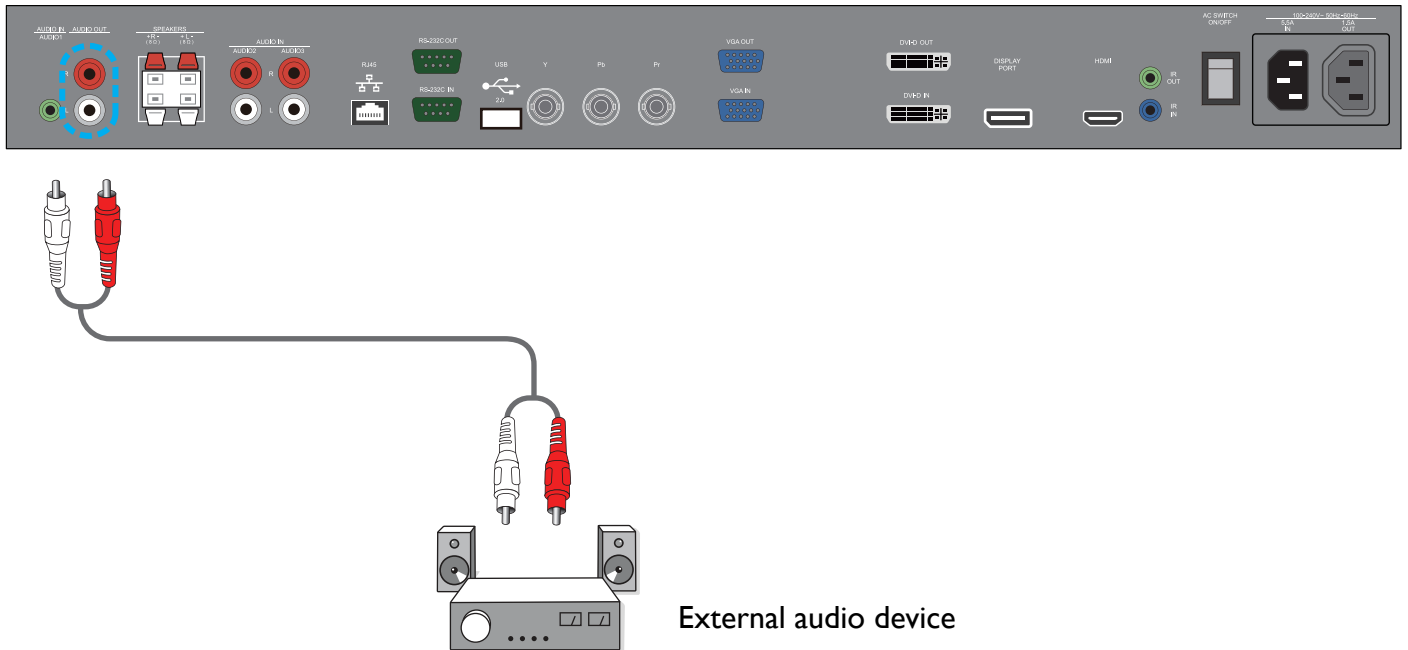

### 3.6. CONNECTING ANOTHER BDL4771V DISPLAY

You can interconnect multiple BDL4771V units to create a daisy-chain configuration for applications such as a video wall.

*Note: The number of displays that can be used in a daisy-chain configuration will depend on the resolution of the input signal being used.*

- Connect the **VGA OUT** connector of the display to the **VGA IN** connector of an additional BDL4771V unit.

*Note: You can connect up to 25 displays using the VGA OUT connectors.*

- Connect the **RS-232C OUT** connector of the display to the **RS-232C IN** connector of an additional BDL4771V unit.
- Connect the **DVI-D OUT** connector of the display to the **DVI-D IN** connector of an additional BDL4771V unit.

*Note:*

- You can connect up to 9 displays by daisy-chaining via DVI-D.
- To ensure optimal image quality, we recommend using a DVI cable of no more than 2 metres in length.

#### Additional BDL4771V display

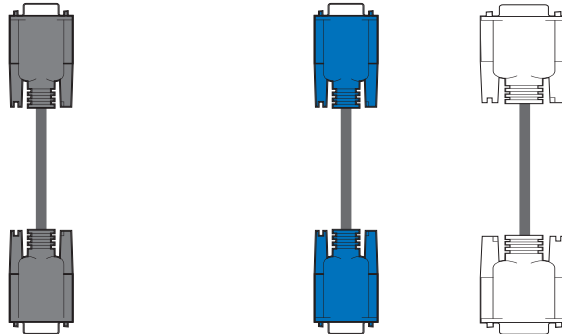
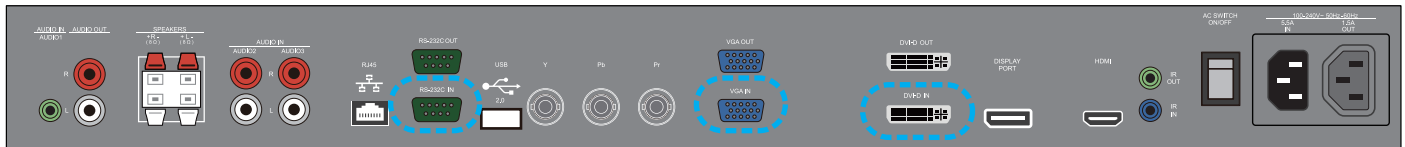

#### The first BDL4771V display

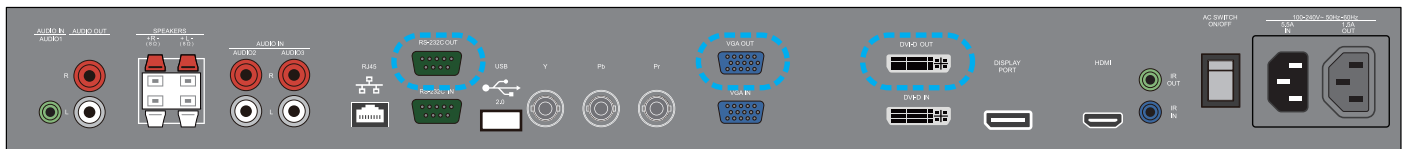



## 4. OSD MENU

An overall view of the On-Screen Display (OSD) structure is shown below. This can be used as a reference for further adjustment of your display.

### 4.1. NAVIGATING THE OSD MENU

#### 4.1.1. NAVIGATING THE OSD MENU USING THE REMOTE CONTROL

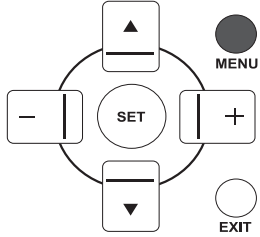

1. Press the **MENU** button on the remote control to display the OSD menu.

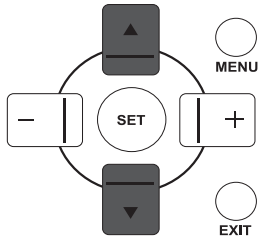

2. Press the **UP/DOWN** button to move the cursor to the item you want to adjust.

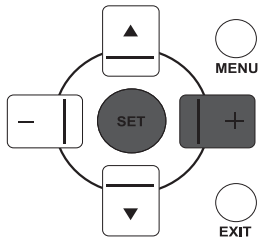

3. Press the **PLUS/SET** button to enter the submenu.

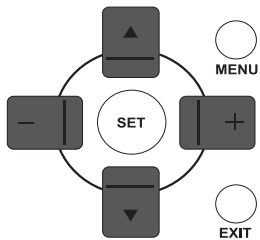

4. In the submenu, press the **UP/DOWN** button to toggle between items, or press the **PLUS/MINUS** button to adjust settings. If there is a submenu, press the **PLUS** button to enter it.

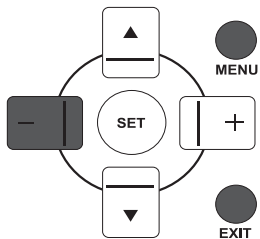

5. Press the **MINUS/EXIT** button on the remote control to return to the previous menu, or press the **MENU** button to exit the OSD menu.

## 4.1.2. NAVIGATING THE OSD MENU USING THE DISPLAY'S CONTROL BUTTONS

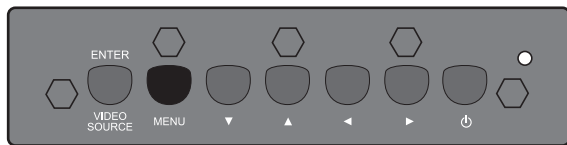

1. Press the **MENU** button to display the OSD menu.

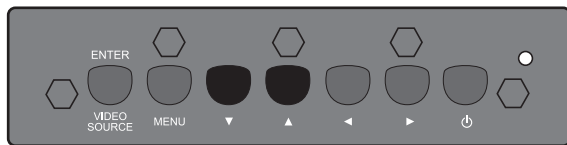

2. Press the ▲/▼ button to move the cursor to the item you want to adjust.

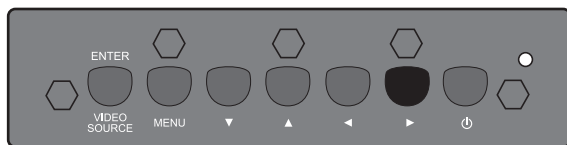

3. Press the ► button to enter the submenu.



4. In the submenu, press the ▲/▼ button to toggle between items, or press ◀ / ▶ button to adjust settings. If there is a submenu, press the ► button to enter it.

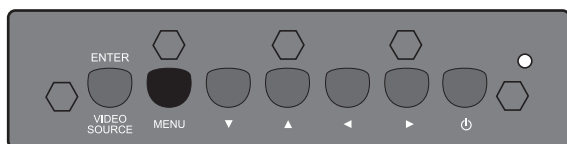

5. Press the **MENU** button on the remote control to return to the previous menu, or press the **MENU** button repeatedly to exit the OSD menu.

## 4.2. OSD MENU OVERVIEW

### 4.2.1. Picture MENU

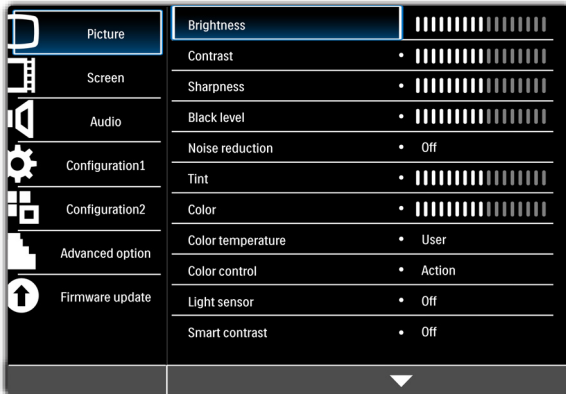

#### Brightness

*Note: This function is not available when Smart contrast, Light sensor or Brightness under Panel saving is turned on. Disable these functions to access Brightness from the OSD menu.*

Adjust the overall image brightness by changing the intensity of the LCD panel's backlight.

Use the **PLUS/MINUS** button to adjust.

#### Contrast

Adjust to change image contrast. The black portions of the picture become richer and the whites become brighter.

Use the **PLUS/MINUS** button to adjust.

#### Sharpness

Adjust to improve detail.

Use the **PLUS/MINUS** button to adjust.

#### Black level

Adjust to change image brightness.

Use the **PLUS/MINUS** button to adjust.

#### Noise reduction

*Note: For Component input with interlaced video only.*

Adjust to remove the noise in the image. You can select a suitable noise reduction level.

Use the **UP/DOWN** button to make selection.

#### Tint

*Note: For Component, and HDMI inputs with YUV color space only. (YUV is a color space typically used as part of a color image pipeline.)*

Adjust to change the color tint of the image.

Use the **PLUS/MINUS** button to adjust. Press the **PLUS** button and the flesh tone color turns slightly green. Press the **MINUS** button and the flesh tone color turns slightly purple.

#### Color

*Note: For Component, and HDMI inputs with YUV color space only. (YUV is a color space typically used as part of a color image pipeline.)*

Adjust to increase or decrease the intensity of colors in the image.

Press the **PLUS** button to increase color intensity, or press the **MINUS** button to decrease it.

### Color temperature

Select a color temperature for the image. A lower color temperature will have a reddish tint, whilst a higher color temperature gives off a more bluish tint.

Use the **UP/DOWN** button to make selection.

### Color control

*Note: This function is only available when Color temperature is set to User.*

With this function you can adjust the color tones of the image precisely by changing the R (Red), G (Green) and B (Blue) settings independently.

Press the **UP/DOWN** button to select **R**, **G** or **B**, and press the **PLUS/MINUS** button to adjust.

### Light sensor

*Note: This function is not available when Smart contrast or Brightness under Panel saving is turned on. Disable these functions to make Light sensor accessible from the OSD menu.*

Choose to enable or disable the ambient light sensor. Once enabled, the image brightness will adjust automatically as the ambient lighting conditions change.

Use the **UP/DOWN** button to make selection.

### Smart contrast

*Note: This function is not available when Light sensor or Brightness under Panel saving is turned on. Disable these functions to make Smart contrast accessible from the OSD menu.*

When turned on, this function helps enhance image contrast when displaying dark scenes.

Use the **UP/DOWN** button to make selection.

### Smart picture

Select a smart picture mode from:

- **Standard:** for images (factory setting)
- **Highbright:** for moving images such as Video
- **sRGB:** for text based images
- **Cinema:** for movies.
- **User:** create your own picture settings. This mode is automatically selected after you change the settings in the **Picture** menu.

Use the **UP/DOWN** button to make selection.

### Video source

Select a video input source.

Use the **UP/DOWN** button to toggle between

- **VGA**
- **DVI-D**
- **Component**
- **DisplayPort**
- **HDMI**

### Picture reset

Reset all settings in the **Picture** menu.

Use the **PLUS/MINUS** button to make selection. Select **Reset** and press the **SET** button to restore settings to factory preset values. Press the **EXIT** button to cancel and return to the previous menu.

## 4.2.2. Screen MENU

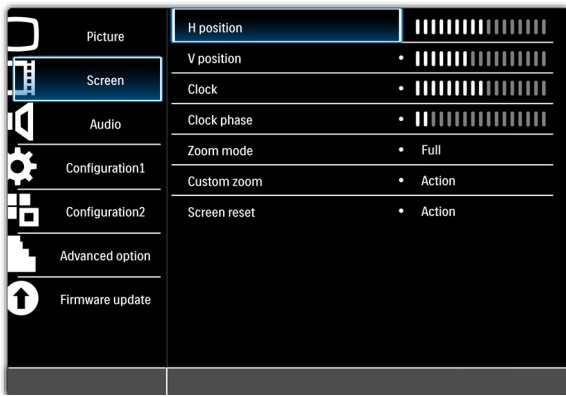

### H position

*Note: For VGA input only.*

Adjust the horizontal placement of the picture.

Press the **PLUS** button to move the image to the right, or press the **MINUS** button to move the image to the left.

### V position

*Note: For VGA input only.*

Adjust the vertical placement of the picture.

Press the **PLUS** button to move the image up, or press the **MINUS** button to move the image down.

### Clock

*Note: For VGA input only.*

Adjust the width of the image.

Press the **PLUS** button to expand the width of the image, or press the **MINUS** button to shrink it.

### Clock phase

*Note: For VGA input only.*

Adjust to improve the focus, clarity and stability of the image.

Use the **PLUS/MINUS** button to adjust.

### Zoom mode

The pictures you receive may be transmitted in 16:9 format (widescreen) or 4:3 format (conventional screen). 16:9 pictures sometimes have a black band at the top and bottom of the screen (letterbox format). This function allows you to optimize the picture display on screen. The following zoom modes are available:

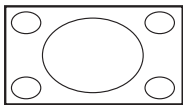

- **Full** - This mode restores the correct proportions of pictures transmitted in 16:9 using the full screen display.

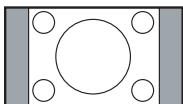

- **Normal** - The picture is reproduced in 4:3 format and a black band is displayed on either side of the picture.

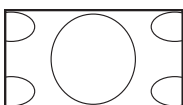

- **Dynamic** - Fill the entire screen by stretching 4:3 pictures non-proportionally.

- **Custom** - Choose to apply the custom zoom settings in the **Custom zoom** submenu.

*Note: This mode does not support deinterlacing. The screen may flicker when displaying interlaced video.*

- **Real** - This mode displays the image pixel-by-pixel on screen without scaling the original image size.

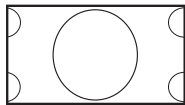

- **21:9** - The picture is enlarged to 21:9 format. This mode is recommended when displaying pictures that have black bands at the top and bottom (letterbox format).

*Note: This mode does not support deinterlacing. The screen may flicker when displaying interlaced video.*

### Custom zoom

*Note: This item is only available when Zoom mode is set to Custom.*

Use this function to further customize the zoom settings to suit the image you want to display.

Use the **UP/DOWN** button to toggle between the following items, and use the **PLUS/MINUS** button to adjust.

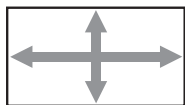

- **Zoom** - Expands the horizontal and vertical sizes of the image simultaneously.



- **H zoom** - Expands the horizontal size of the image only.



- **V zoom** - Expands the vertical size of the image only.

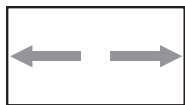

- **H position** - Moves the horizontal position of the image left or right.

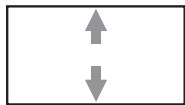

- **V position** - Moves the vertical position of the image up or down.

### Screen reset

Reset all settings in the **Screen** menu.

Use the **PLUS/MINUS** button to make your selection. Select **Reset** and press the **SET** button to restore settings to factory preset values. Press the **EXIT** button to cancel and return to the previous menu.

### 4.2.3. Audio MENU

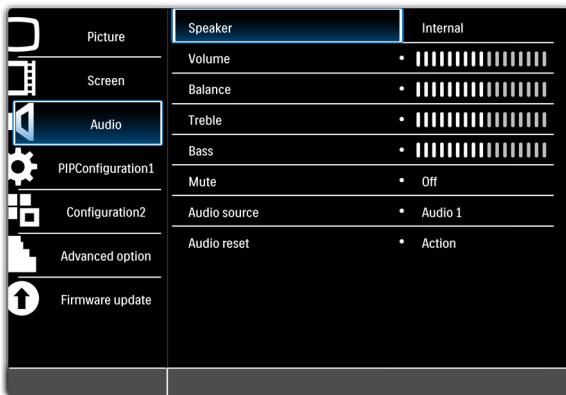

#### Speaker

Set the display to play audio using the built-in (internal) speaker, external speakers or external audio devices (if connected).

Use the **UP/DOWN** button to toggle between

- **Internal**
- **External**
- **Line-out**

#### Volume

Adjust to increase or decrease the audio output level.

Use the **PLUS/MINUS** button to adjust.

#### Balance

Adjust to increase or decrease the audio balance level.

Use the **PLUS/MINUS** button to adjust.

#### Treble

Adjust to increase or decrease the treble.

Use the **PLUS/MINUS** button to adjust.

#### Bass

Adjust to increase or decrease the bass.

Use the **PLUS/MINUS** button to adjust.

#### Mute

Turns the mute function on/off.

Use the **UP/DOWN** button to make selection.

#### Audio source

Select the audio input source – toggle between audio input, DISPLAYPORT, and HDMI.

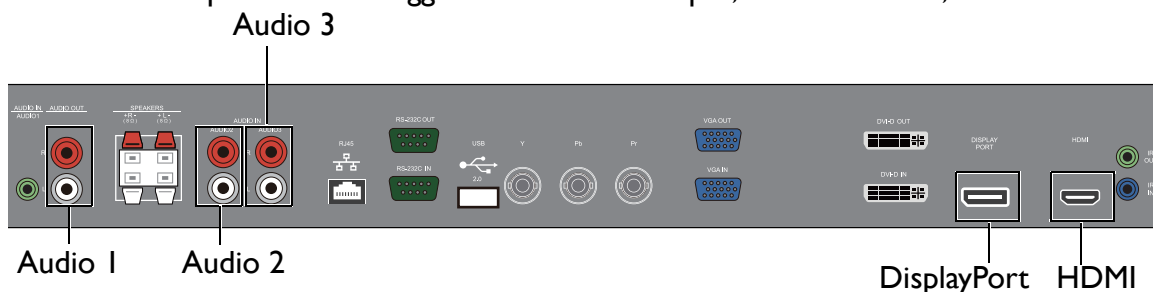

Use the **UP/DOWN** button to toggle between

- **Audio 1**
- **Audio 2**
- **DisplayPort**

[RETURN TO THE CONTENTS](#)

• **Audio 3**

• **HDMI**

**Audio reset**

Reset all settings in the **Audio** menu.

Use the **PLUS/MINUS** button to make selection. Select **Reset** and press the **SET** button to restore settings to factory preset values. Press the **EXIT** button to cancel and return to the previous menu.



## 4.2.4. Configuration I MENU

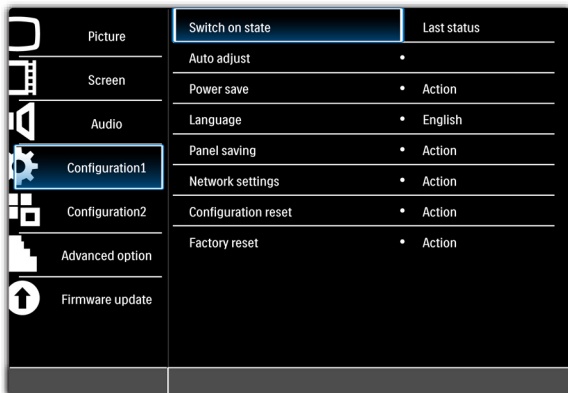

### Switch on state

Set the display to turn on or remain off when the power cord is connected to a wall outlet.

Use the **UP/DOWN** button to toggle between

- **Last status** - The display will return to the previous power status (on/off/standby) when removing and replacing the power cord.
- **Forced on** - The display will turn on when the power cord is connected to a wall outlet.
- **Power off** - The display will remain off when the power cord is connected to a wall outlet.

*Note: If you unplug the power cord and re-plug within 7 seconds, the display will not work under the selected setting.*

### Auto adjust

*Note: For VGA input only.*

Use this function to automatically optimize the VGA image within the display. Press **SET** to adjust.

### Power save

Set the display to reduce the power consumption.

Use the **UP/DOWN** button to toggle between

- **PC** - Select **On** to let the display enter DPMS (Display Power Management Signaling) mode when no signal can be detected from the HDMI, DVI-D, and VGA inputs after three successive cycles. Use the **PLUS/MINUS** button to make selection.
- **Video** - Select **On** to let the display enter power saving mode when no signal is detected from the Component input after three successive cycles. Use the **PLUS/MINUS** button to make your selection.

### Language

Select the language for the OSD menu.

Use the **UP/DOWN** button to select a language.

### Panel saving

Choose to enable the panel saving functions to reduce the risk of the "image persistence". Use the **UP/DOWN** button to toggle between

- **Brightness** - Select **On** and the brightness of the image will be reduced to an appropriate level, and the **Brightness** setting in the **Picture** menu will become unavailable. Use the **PLUS/MINUS** button to make selection.
- **Pixel shift** - Select the time interval for the display to slightly expand the image size and shift the pixel position in four directions (up, down, left, and right). Use the **PLUS/MINUS** button to make selection (**Off-900** seconds from current time). The default time interval is 300 seconds. This helps to alleviate the issues of image sticking.

**IMPORTANT:** It is not recommended to keep a single static image displayed on your unit for long periods of time. This can cause image sticking, or ghost imaging, which will decrease the quality of your images. In

some instances, ghost image damage can be permanent. To avoid such issues, we strongly recommend one of the following actions:

- Change the picture periodically
- Enable **Pixel shift** (See Pixel shift under Section 4.2.4.Configuration I MENU)
- Use a screen saver with changing images

## Network settings

To set the display to connect to a local area network:

1. Connect a RJ-45 cable to the corresponding ports on the display and your LAN switch or router.
2. Enter the submenu of Network settings. You will see the OSD page similar to the following picture.

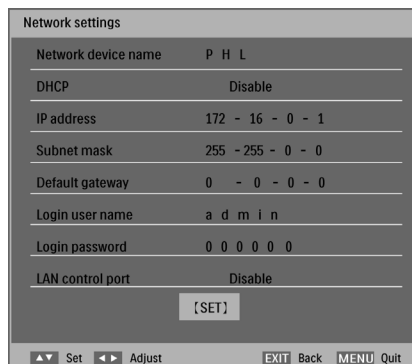

3. Use the **UP/DOWN/PLUS/MINUS** buttons to set the **Network device name**.
4. If you are in a DHCP environment, highlight **DHCP** and select **Enable**. Once selected, the **IP address**, **Subnet mask**, and **Default gateway** settings will be displayed. If you are not in a DHCP environment, highlight **DHCP** and select **Disable**. Contact your ITS administrator for information on the **IP address**, **Subnet mask**, and **Default gateway** settings and enter it accordingly.
5. Make sure the information on the **Login user name** is displayed.
6. Use the **UP/DOWN/PLUS/MINUS** buttons to set **Login password**. The password is required when using a computer browser to log in.
7. To control the display with a computer browser, highlight **LAN control port** and select **Enable**.
8. To save the settings and return to the previous menu, highlight **Set** and press the **SET** button on the remote control.

Once you have the correct IP address for your display and the display is on or in standby mode, you can use any computer that is on the same local area network to control the display.

Notes:

- You cannot control the display via RS-232C when LAN is being used.
  - Currently most browsers are supported. However, if using Internet Explorer, only versions 7.0 or higher are supported.
  - The screen shots in this manual are for reference only, and may differ from what is displayed on your screen.
1. Enter the address of the display in the address bar of your browser and press Enter. The Login page appears. Here is an example of the complete address: <http://172.16.0.1/html>.

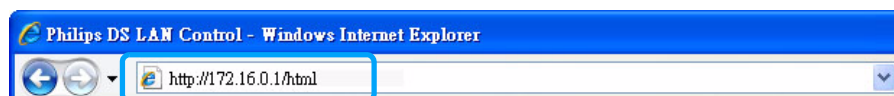

2. Enter the same password you have set in the **Network settings > Login password** menu and press Login. If the password has not been set, enter the default "000000".

User Name	admin
Password	<input type="password"/>
Login	

3. The setting page appears.

- **Power Setup:** Allows you to manage the power status.

*Note: Make sure the LAN control port in the Configuration 1 > Network settings menu is set to Enable to turn on the display using the browser.*

SICP version	<input type="text"/>
SW version	<input type="text"/>
Power	<input checked="" type="radio"/> On <input type="radio"/> Off
Switch on state	<input type="radio"/> Power off <input checked="" type="radio"/> Force on <input type="radio"/> Last status
Video source	<input type="text"/>
Smart power	<input type="radio"/> Off <input type="radio"/> Medium <input checked="" type="radio"/> High

- **A/V Setup:** Provides various options for video and audio control.

Brightness	-	0	+
Contrast	-	0	+
Sharpness	-	0	+
Color	-	0	+
Tint	-	0	+
Light sensor	<input checked="" type="radio"/> On <input type="radio"/> Off		
Zoommode	<input type="text"/>		
Auto adjust			
Auto detection	<input type="radio"/> On <input checked="" type="radio"/> Off		
Volume	-	0	+
Treble	-	0	+
Bass	-	0	+

- **Configuration Setup:** Most frequently used settings are provided on this page for you to control the display.

OSD mode	<input type="radio"/> On <input checked="" type="radio"/> Off
Input control	Apply
Keypad lock	<input type="radio"/> Lock <input checked="" type="radio"/> Unlock
Remote lock	<input type="radio"/> Lock <input checked="" type="radio"/> Unlock
PIP control	Apply
PIP input	<input type="text"/>
PIP setting	<input type="radio"/> On <input checked="" type="radio"/> Off
Operation hours	<input type="text"/>
Serial no	<input type="text"/>
Temperature	<input type="text"/>

- **Tiling Setup:** Allows you to arrange multiple displays in a video wall or matrix and define the position and ID of each.

Power Setup	H monitors	<input type="text"/>	
A/V Setup	V monitors	<input type="text"/>	
Configuration Setup	Position	<input type="text"/>	<input type="button" value="Apply"/>
<b>Tiling Setup</b>	Frame comp	<input type="radio"/> On <input checked="" type="radio"/> Off	
General Setup	Tiling enable	<input type="radio"/> On <input checked="" type="radio"/> Off	

- **General Setup:** Changes the password settings.

Power Setup	Change Password for Webpage		
A/V Setup	Enter Old password	<input type="text"/>	
Configuration Setup	Enter New password	<input type="text"/>	
Tiling Setup	Confirm New password	<input type="text"/>	<input type="button" value="Apply"/>
<b>General Setup</b>			

### Configuration reset

Resets all settings in the **Configuration I** menu.

Use the **PLUS/MINUS** button to make selection. Select **Reset** and press **SET** to restore settings to factory preset values. Press **EXIT** to cancel and return to the previous menu.

### Factory reset

Resets all settings in the **Picture, Screen, Audio, PIP, Configuration I, Configuration 2,** and **Advanced option** menus, restoring them to factory preset values. Use the **PLUS/MINUS** button to make selection. Select **Reset** and press **SET** to restore settings to factory preset values. Press the **EXIT** button to cancel and return to the previous menu.

## 4.2.5. Configuration 2 MENU



### OSD turn off

Set the period of time the OSD menu stays on the screen (from **5** to **120** seconds since the last key stroke)  
Use **PLUS/MINUS** to adjust.

### OSD mode

Select the orientation of the OSD according to the orientation the display is installed.

Use the **PLUS/MINUS** button to toggle between

- **Portrait**
- **Landscape**

### Information OSD

Set the period of time the information OSD stays on the screen. The information OSD will display when input signal is changed.

Use the **UP/DOWN** button to adjust. The information OSD will not appear when **Off** is selected. If **0** is selected, the information OSD will remain on the screen.

### Sleep timer

Set the display to turn itself off to standby mode within a user-specified amount of time. (**Off-24** hours from current time)

Use the **UP/DOWN** button to adjust.

*Note: When the Sleep timer is activated, Schedule settings will be disabled.*

### OSD H position

Adjust the horizontal position of the OSD menu.

Use the **UP/DOWN** button to adjust.

### OSD V position

Adjust the vertical position of the OSD menu.

Use the **UP/DOWN** button to adjust.

### Monitor information

Shows the information about your display including model name, serial no., hours of operation, firmware version and MCU version being used.

Press the **PLUS** button to view the information. Press the **EXIT** button to return to the previous menu.

## 4.2.6. Advanced option MENU

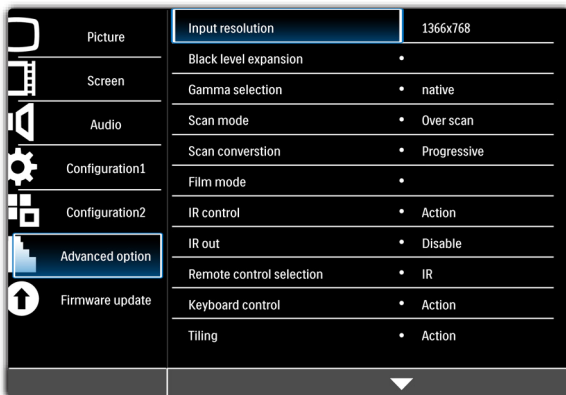

### Input resolution

*Note: For VGA input only.*

Set the resolution of the VGA input. This is only required when the display is unable to detect the VGA input resolution correctly.

Use **UP/DOWN** to toggle between

- **Auto**
- **1024x768**
- **1280x768**
- **1360x768**
- **1366x768**

### Black level expansion

*Note: For Component, and HDMI (video mode) inputs only.*

This feature offers deeper blacks for an even better image quality. Select a suitable black level expansion setting to reveal more details in the dark parts of an image.

Use **UP/DOWN** to toggle between

- **Off**
- **Low**
- **Medium**
- **High**

### Gamma selection

Gamma is what controls the overall brightness of an image. Images which are not corrected properly can appear too white or too dark, so controlling the gamma properly can have a huge influence on the overall picture quality of your display.

Select a display gamma value to best suit the image and optimize image brightness and contrast.

Use the **UP/DOWN** button to toggle between

- **2.2**
- **2.0**
- **Native**

### Scan mode

*Note: For Component, and HDMI (video mode) inputs only.*

Change the display area of the image.

Use the **UP/DOWN** button to toggle between

- **Overscan** - Displays about 95% of the original size of the image. The rest of the areas surrounding the image will be cut off.
- **Underscan** - Displays the image in its original size.

### Scan conversion

*Note: For Component, and HDMI (video mode) inputs only.*

Choose to enable or disable the IP (Interlace to Progressive) conversion function.

Use the **UP/DOWN** button to toggle between

- **Progressive** - Enable the IP conversion function (recommended). Once enabled, the interlace input signal will be converted to progressive format for better display quality.
- **Interlace**: Disable the IP function. This mode is suitable for displaying motion pictures, but increases the chance of image retention.

### Film mode

*Note: For Component, and HDMI (video mode) inputs only.*

Choose to turn on or off the film mode frame conversion function.

Use the **UP/DOWN** button to toggle between

- **Auto** - Enable the film mode frame conversion function for movies and motion pictures. The display converts a 24 frames-per-second (24 fps) input signal format into DVD video signal format. Once this function is enabled, we recommend that you set the **Scan conversion** function to **Progressive**.
- **Off** - Disable the film mode frame conversion function. This mode is suitable for TV broadcasting and VCR signals.

### IR control

Select the operation mode of the remote control when multiple BDL4771V units are connected via RS-232C cables.

Use the **UP/DOWN** button to toggle between

- **Normal** - All units can be operated normally by the remote control.
- **Primary** - Designate this display as the primary unit for remote control operation. Only this display will be operated by the remote control.
- **Secondary** - Designate this display as the secondary unit. This display can not be operated by the remote control, and will only receive the control signal from the primary unit via the RS-232C connection.
- **Lock** - Lock the remote control function of this display. To unlock, press and hold the **DISPLAY** button on the remote control for 5 seconds.

### IR out

Select **Enable** to operate multiple units with one IR remote control. Point the remote control to the first display which IR OUT port connects to the second display's IR IN port, and the second display's IR OUT port connects to the third display's IR IN port, and so on.

### Remote control selection

Select **IR** or **RF** according to the remote control you wish to use. You can use the RF remote to control multiple BDL4771V units in a video wall.

### Keyboard control

Choose to enable or disable the function of the keyboard (control buttons) on the display.

Use the **UP/DOWN** button to toggle between

- **Lock** - Disable the keyboard.
- **Unlock** - Enable the keyboard.

### Tiling

*Note: This function is not available when PIP is turned on. Disable PIP to make Tiling accessible from the OSD menu.*

With this function you can create a single large screen matrix (display wall) that consists of up to 150 BDL4771V displays (10 units on the vertical side and 15 units on the horizontal side).

Example:

2 x 2 screen matrix (4 displays)

H monitors = 2

V monitors = 2

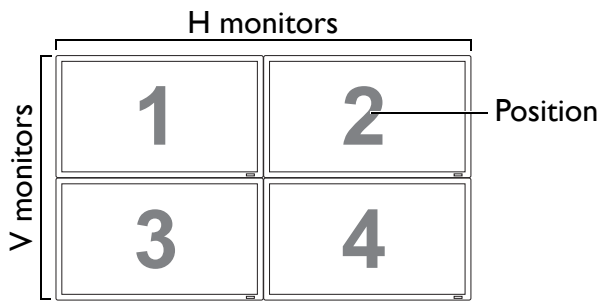

5 x 5 screen matrix (25 displays)

H monitors = 5

V monitors = 5

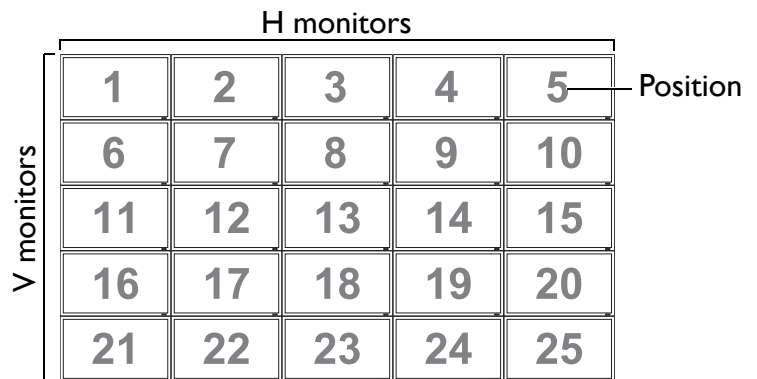

10 x 15 screen matrix (150 displays)

H monitors = 15

V monitors = 10

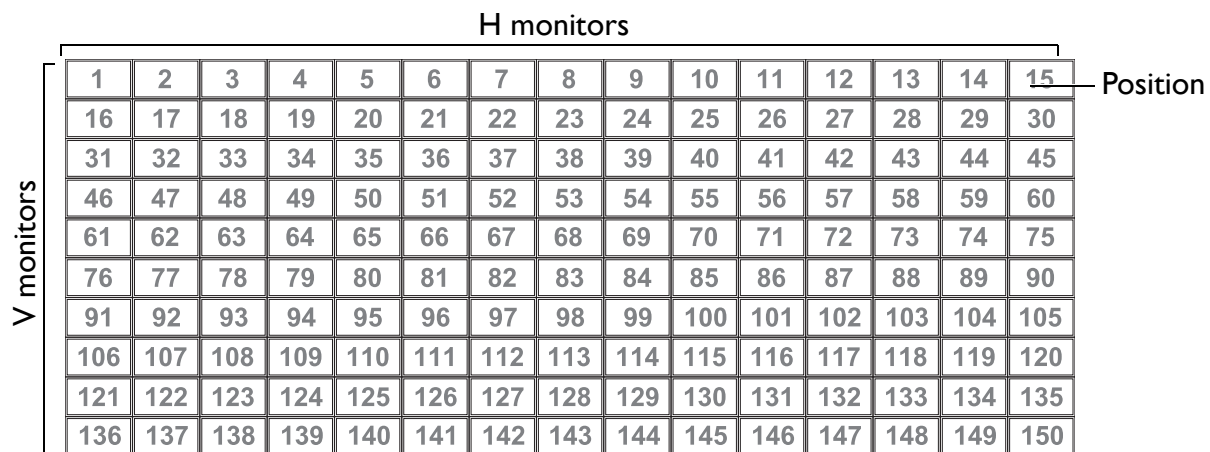

- **H monitors** - Select the number of displays on the horizontal side.
- **V monitors** - Select the number of displays on the vertical side.
- **Position** - Select the position of this display in the screen matrix. Position is defined by the total number of displays in the video wall counting from the top, left hand display and counting horizontally. The number is then continued on the next row down, and the procedure is continued until the final display is reached. See examples above for further explanation.
- **Frame comp.** - Choose to turn frame compensation on or off. If turned on, the display will adjust the image to compensate for the width of the bezels in order to accurately display the image.

Frame comp. - Off

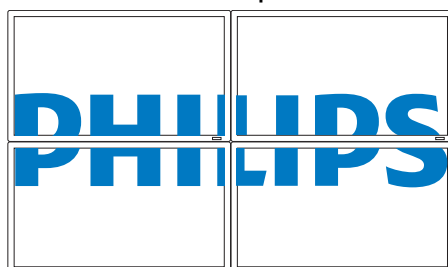

Frame comp. - On

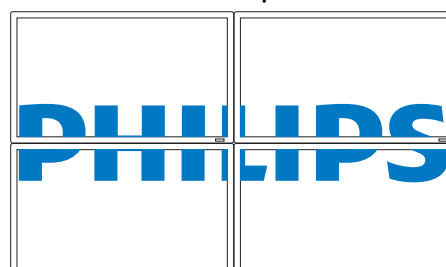

- **Enable:** Choose to enable or disable the **Tiling** function. If enabled, the display will apply the settings in **H monitors**, **V monitors**, **Position**, and **Frame comp.**.



Note: PIP function is disabled when Tiling is enabled.

- **Switch on delay:** Choose to enable or disable a sequence in turning on the screen matrix. If enabled, the display will turn on one horizontal matrix at a time starting from the top row.

**Heat status**

This function allows you to check the thermal status of the display at any time. The accuracy of the temperature indicated is  $\pm 5$  degrees Celsius.

Press the **PLUS** button to view the heat status. Press the **EXIT** button to return to the previous menu.

**Date and time**

Adjusts current date and time for the display’s internal clock.

Press the **UP/DOWN** button to toggle between the **Year, Month, Day, Hour, Minute,** and **Daylight saving time** settings, and then press the **PLUS/MINUS** button to adjust.

**Schedule**

Note: Please set up current date and time in Date and time before using the Schedule function.

This function allows you to program up to seven different scheduled time intervals for the display. You can select the time the unit turns on and turns off, the days in a week it is activated, and which input source the display will use for each scheduled activation period.

For example, if you wish to turn the display on automatically at 7:30 AM and off at 10:30 PM on Tuesdays and Wednesdays and display the signal from the HDMI input:

		Time																								
		0:00	1:00	2:00	3:00	4:00	5:00	6:00	7:00	8:00	9:00	10:00	11:00	12:00	13:00	14:00	15:00	16:00	17:00	18:00	19:00	20:00	21:00	22:00	23:00	
Day	MON													Off												
	TUE				Off										On											Off
	WED				Off										On											Off
	THU													Off												
	FRI													Off												
	SAT													Off												
	SUN													Off												

Perform the following steps:

1. With the **Schedule** item highlighted in the **Advanced option** menu, press the **PLUS** button to open the submenu.

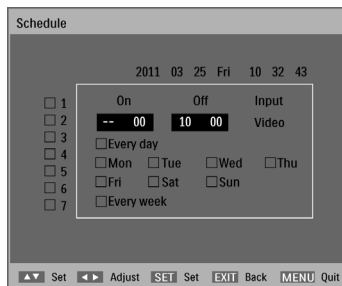

2. Press the **UP/DOWN** button to select schedule item #1 (☑ 1), then press **SET**. A check mark will appear in the box indicating that the schedule item has been selected.
3. With the **On** item highlighted, press the **SET** button and then press the **UP/DOWN** button to set the power on hour to "07".
4. Press the **PLUS** button to move to the minute slot. Press the **UP/DOWN** button to set the power on minute to "30", then press the **EXIT** button.
5. Press the **PLUS** button to highlight the **Off** item. Press the **SET** button, and then press the **UP/DOWN** button to set the power off hour to "22".

6. Press the **PLUS** button to move to the minute slot. Press the **UP/DOWN** button to set the power off minute to "30", then press the **EXIT** button.
7. Press the **PLUS** button to highlight the **Input** item, and then press the **UP/DOWN** button to select **HDMI**.
8. Press the **PLUS** button to select  **Tue** and then press the **SET** button. A check mark will appear in the box indicating that it has been selected.
9. Press the **PLUS** button to select  **Wed** and then press the **SET** button. A check mark will appear in the box indicating that it has been selected.
10. Now you have completed the schedule settings. The on-screen display should look like the illustration below:

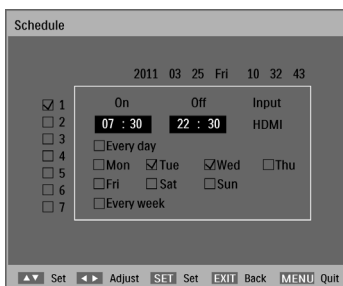

11. Press the **EXIT** button and the menu will close and the schedule settings will take effect.

To set up more schedule items, repeat the steps above except that a different schedule item should be selected (schedule item #2 ( 2) through #7 ( 7)) in step 2.

Notes:

- Seven scheduling options are available so that you can choose between different video input modes for different schedules during the week. For example, VGA input on a Monday, HDMI on Tuesday to Friday, S-Video for weekends.
- If you do not want to use a power on time, select "--" for the power on hour slot, and "00" for the minute slot. The display will only turn off at the time you set.
- If you do not want to use a power off time, select "--" for the power off hour slot, and "00" for the minute slot. The display will only turn on at the time you set.
- If no input source is selected, the default input source (Video) will be used.
- If Every day is selected, the display will turn on everyday regardless of other day settings (e.g Mon, Tue, Wed..., etc.).
- Should schedule periods overlap, the power on time has priority over power off time. For example, if schedule item #1 sets the display to power on at 10:00 AM and off at 5:00 PM, and schedule item #2 sets the display to power on at 4:00 PM and off at 9:00 PM on the same day, then the display will power on at 10:00 AM and off at 9:00 PM.
- If there are multiple schedule items programmed for the same time period, then the highest numbered schedule item has priority. For example, if schedule items #1 and #2 both set the display to power on at 7:00 AM and off at 5:00 PM, then only schedule item # 1 will take effect.

## Monitor ID

Set the ID number for controlling the unit via the RS-232C connection. Each display must have a unique ID number when multiple BDL4771V units are connected. Each monitor's ID is defined by its position within the matrix – starting on the top row, working left to right. The top left display will have an ID of 1. When you reach the end of the row, the next number will refer to the display one row down, starting at the left.

## DDC/CI

Choose to turn **On** or **Off** the DDC/CI communication function. Select On for the SmartControl II software use.

Use the **UP/DOWN** button to make selection.

### **HDMI with One Wire**

One Wire uses the HDMI CEC (Consumer Electronics Control) industry standard protocol to share functionality between connected devices and the display. To transfer system commands, you need to use an HDMI cable to connect the display to a device equipped with HDMI CEC. Select **On** in this menu and you can operate the main functionalities on your display and the connected device with one remote control. For instructions on how to use the One Wire function, please refer to the One Wire DFU on the accompanying CD ROM.

Notes:

- *The One Wire-compliant device must be switched on and selected as the source.*
- *We do not guarantee 100% interoperability with all HDMI CEC devices.*

### **Smart power**

Set the display to reduce the power consumption automatically. Setting to **High** will bring the most power savings.

Use the **UP/DOWN** button to toggle between

- **Off**
- **Medium**
- **High**

### **Auto signal detection**

Select to let the unit detect and display available signal source automatically.

- **On** - Set the unit to display the image automatically once a signal is connected.
- **Off** - Once a signal is connected, it can only be selected manually.

Use the **UP/DOWN** button to make selection.

### **Settings cloning**

Select Monitor to USB or USB to Monitor to transfer all the OSD settings between the display and a USB flash drive.

### **Advanced option reset**

Reset all settings in the **Advanced option** menu.

Press the **PLUS** button to open the submenu, and then press **PLUS/MINUS** to make selection. Select **Reset** and press the **SET** button to restore settings to factory preset values. Press the **EXIT** button to cancel and return to the previous menu.

## 4.2.7. Firmware update MENU

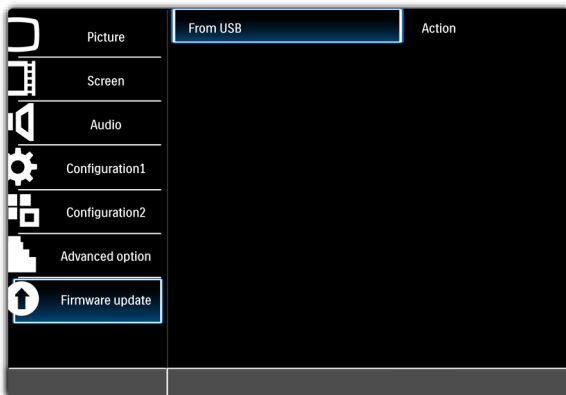

### From USB

To update the display firmware:

1. Take a USB flash drive and make sure it is formatted with FAT32.
2. Create a folder and name it “fupgrade” on the USB flash drive.
3. Obtain the firmware named “usb\_rootfs” and put it into the folder “fupgrade”.
4. Plug the USB flash drive into the USB port on the display.
5. Highlight Action in the Firmware update > From USB menu and press SET.
6. Select Yes to start update. A status message appears.
7. After the update process completes, the display will re-start automatically.

Notes:

- The display does not support USB flash drives with NTFS format.
- Do not turn off the display during the update process. It may damage the display if you do.
- If the error message appears on the Firmware Update OSD menu, please make sure that:
  - the USB flash drive is properly plugged in.
  - the folder name (fupgrade) and file name (usb\_rootfs) are correct.
  - the model name shown on the OSD menu is the same as the display's.
  - the firmware version is different from the old one. The display will not be updated if you are using the same version.

## 5. INPUT MODE

### VGA Resolution

Standard Resolution	Active Resolution		Refresh Rate	Pixel Rate	Aspect Ratio	Stand for Mode
	H Pixels	V Lines				
VGA	640	480	60 Hz	25.175 MHz	4:3	Video Graphic Array
			72 Hz	31.5 MHz		
			75 Hz	31.5 MHz		
WVGA	720	400	70 Hz	33.75 MHz	16:9	Wide Video Graphic Array
SVGA	800	600	60 Hz	40 MHz	4:3	Super VGA
			75 Hz	49.5 MHz		
XGA	1024	768	60 Hz	65 MHz	4:3	Extended Graphic Array
			75 Hz	78.75 MHz		
WXGA	1280	768	60 Hz	79.5 MHz	5:3	Wide XGA
WXGA	1280	800	60 Hz	79.5 MHz	16:10	Wide XGA
SXGA	1280	960	60 Hz	108 MHz	4:3	Super XGA
SXGA	1280	1024	60 Hz	108 MHz	5:4	Super XGA
WXGA	1360	768	60 Hz	85.5 MHz	16:9	Wide XGA
WXGA	1366	768	60 Hz	85.5 MHz	16:9	Wide XGA
UXGA	1600	1200	60 Hz	162 MHz	4:3	Ultra XGA
HDI080	1920	1080	60 Hz	148.5 MHz	16:9	HDI080

### SDTV Resolution

Standard Resolution	Active Resolution		Refresh Rate	Pixel Rate	Aspect Ratio	Stand for Mode
	H Pixels	V Lines				
480i	720	480	29.97 Hz	13.5 MHz	4:3	Modified NTSC Standard
480p			59.94 Hz	27 MHz		
576i	720	480	25 Hz	13.5 MHz	4:3	Modified PAL Standard
576p			50 Hz	27 MHz		

### HDTV Resolution

Standard Resolution	Active Resolution		Refresh Rate	Pixel Rate	Aspect Ratio	Stand for Mode
	H Pixels	V Lines				
720p	1280	720	50 Hz	74.25 MHz	16:9	Normally DVB Mode
			60 Hz			
1080i	1920	1080	25 Hz	74.25 MHz	16:9	Normally ATSC Mode
			30 Hz			
1080p	1920	1080	50 Hz	148.5 MHz	16:9	Normally ATSC Mode
			60 Hz			

- PC text quality is optimum in HD 1080 mode (1920 x 1080, 60Hz).
- Your PC monitor may appear differently depending on the manufacturer (and your particular version of Windows). Check your PC instruction book for information about connecting your PC to a display.

- If a vertical and horizontal frequency-select mode exists, select 60Hz (vertical) and 31.5KHz (horizontal). In some cases, abnormal signals (such as stripes) might appear on the screen when the PC power is turned off (or if the PC is disconnected). If this happens, press the **INPUT** button to enter the video mode. Also, make sure that the PC is connected.
- If horizontal synchronous signals seem irregular in RGB mode, check PC power saving mode or cable connections.
- The display settings table complies with IBM/VESA standards, and based on analog input.

## 6. PIXEL DEFECT POLICY

We strive to deliver the highest quality products and use some of the industry's most advanced manufacturing processes whilst practicing stringent quality control. However, pixel or sub-pixel defects on the PDP / TFT panels used in Plasma- & LCD- displays are sometimes unavoidable. No manufacturer can guarantee that all panels will be free from pixel defects, but Philips guarantees that any LCD display with an unacceptable number of defects will be repaired during the warranty period in line with your local guarantee conditions.

This notice explains the different types of pixel defects and defines the acceptable defect level for the BDL4771V LCD screen. In order to qualify for repair under warranty, the number of pixel defects must exceed a certain level as shown in the reference table. If the LCD screen is within specification a warranty exchange / claim back will be refused. Additionally, because some types or combinations of pixel defects are more noticeable than others, Philips sets even higher quality standards for those.

### 6.1. PIXELS AND SUB-PIXELS

A pixel, or picture element, is composed of three sub-pixels in the primary colors of red, green and blue. Many pixels together form an image. When all sub-pixels of a pixel are lit, the three colored sub-pixels together appear as a single white pixel. When all are dark, the three colored sub-pixels together appear as a single black pixel. Other combinations of lit and dark sub-pixels appear as single pixels of other colors.

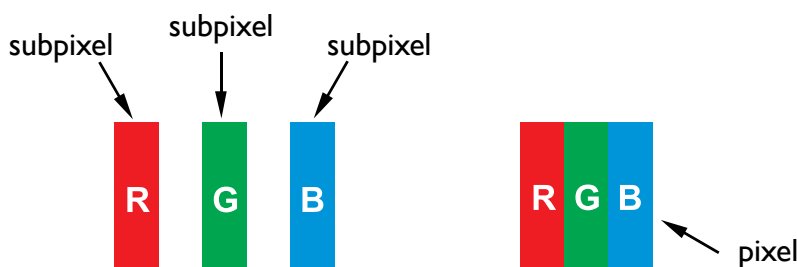

### 6.2. TYPES OF PIXEL DEFECTS + DOT DEFINITION

Pixel and sub-pixel defects appear on the screen in different ways. There are three categories of pixel defects and several types of sub-pixel defects within each category.

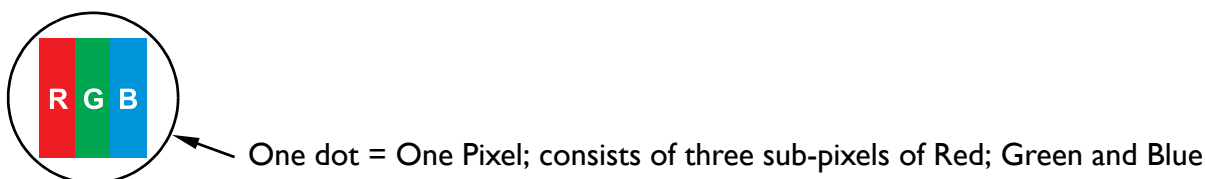

#### Dot definition = What is a defective "Dot"?

One or more defective, adjacent sub-pixel is defined as one "dot". The number of defective sub-pixels is not relevant to define a defective dot. This means that a defective dot can consist of one, two or three defective sub-pixels which can be dark or lit.



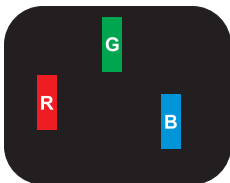
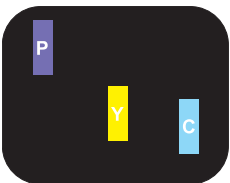

### 6.3. BRIGHT DOT DEFECTS

Bright dot defects appear as pixels or sub-pixels that are always lit or "on". These are the examples of bright dot defects:

		
<p>One lit red, green or blue sub-pixel</p>	<p>Two adjacent lit sub-pixels:</p> <ul style="list-style-type: none"> <li>- Red + Blue = Purple</li> <li>- Red + Green = Yellow</li> <li>- Green + Blue = Cyan (Light Blue)</li> </ul>	<p>Three adjacent lit sub-pixels (one white dot)</p>

### 6.4. DARK DOT DEFECTS

Black dot defects appear as pixels or sub-pixels that are always dark or "off". These are the examples of black dot defects:

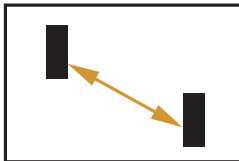
		
<p>One dark dot</p>	<p>Two adjacent dark dots = 1 pair of dark dots</p>	<p>Two dark dots, specifications define the minimum distance between dark dots</p>

### 6.5. PROXIMITY OF PIXEL DEFECTS

Because pixel and sub-pixels defects of the same type that are nearby one another may be more noticeable, Philips also specifies tolerances for the proximity of pixel defects. In the table below you can find specifications about:

- Allowed amount of adjacent dark dots = (adjacent dark dots = 1 pair of dark dots)
- Minimum distance between dark dots
- Total no. of all defective dots

### 6.6. PIXEL DEFECT TOLERANCES

In order to qualify for repair due to pixel defects during the warranty period, a PDP/TFT panel in a Philips LCD display must have pixel or sub-pixel defects exceeding the tolerances listed in the following table.

BRIGHT DOT EFFECT	ACCEPTABLE LEVEL
MODEL	BDL4771V
1 lit sub pixel	10
BLACK DOT EFFECT	ACCEPTABLE LEVEL
1 dark sub pixel	8
<b>TOTAL DOT DEFECTS OF ALL TYPES</b>	<b>9</b>

Note: \* 1 or 2 adjacent sub pixel defects = 1 dot defect

### 6.7. MURA

Dark spots or patches may occasionally appear on some liquid crystal display (LCD) panels. This is known within the industry as Mura, which is a Japanese term for "unevenness." It is used to describe an irregular pattern or area in which uneven screen uniformity appears under certain conditions. Mura is a result of the deterioration of the liquid crystal alignment layer and is most commonly caused by long-term operation under high ambient temperatures. It is an industry-wide phenomenon and Mura is not repairable. It is also not covered by our warranty terms.



Mura has been around since the introduction of LCD technology and with screens getting bigger and in operation 24/7, many displays are running in low light conditions. This all adds to the possibility of Mura affecting displays.

### **6.7.1. HOW TO SPOT MURA**

There are many symptoms of Mura and also multiple causes. Several of these are listed below:

- Impurities or foreign particles in the crystal matrix
- Uneven distribution of LCD matrix during manufacturing
- Non-uniform luminance distribution of the backlight
- Panel assembly induced stress
- Flaws within the LCD cells
- Thermal induced stress - high temperature operation over long periods of time

### **6.7.2. HOW TO AVOID MURA**

Although we can not guarantee the complete eradication of Mura every time, in general the appearance of Mura can be minimized by these methods:

- Lower the backlight brightness
- Use a screen saver
- Reduce the ambient temperature around the unit

## 7. CLEANING AND TROUBLESHOOTING

### 7.1. CLEANING

#### Caution When Using the Display

- Do not place your hands, face or objects close to the ventilation holes of the display. The top of the display is usually very hot due to the high temperature of air being expelled through the ventilation holes. Burns or personal injuries may occur if any body parts are brought too close. Placing any object near the top of the display could also result in heat related damage to the object as well as the display itself.
- Be sure to disconnect all cables before moving the display. Moving the display with its cables attached may damage the cables and thus cause fire or electric shock.
- Disconnect the power plug from the wall outlet as a safety precaution before carrying out any type of cleaning or maintenance procedure.

#### Front Panel Cleaning Instructions

- The front of the display has been specially treated. Wipe the surface gently using only a cleaning cloth or a soft, lint-free cloth.
- If the surface becomes dirty, soak a soft, lint-free cloth in a mild detergent solution. Wring the cloth to remove excess liquid. Wipe the surface of the display to remove dirt. Then use a dry cloth of the same type to dry.
- Do not scratch or hit the surface of the panel with fingers or hard objects of any kind.
- Do not use volatile substances such as sprays, solvents and thinners.

#### Cabinet Cleaning Instructions

- If the cabinet becomes dirty, wipe with a soft, dry cloth.
- If the cabinet is extremely dirty, soak a lint-free cloth in a mild detergent solution. Wring the cloth to remove as much moisture as possible. Wipe the cabinet. Use another dry cloth to wipe over until the surface is dry.
- Do not allow any water or detergent to come into contact with the surface of the display. If water or moisture gets inside the unit, operating problems, or electrical and shock hazards may result.
- Do not scratch or hit the cabinet with fingers or hard objects of any kind.
- Do not use volatile substances such as sprays, solvents and thinners on the cabinet.
- Do not place anything made from rubber or PVC near the cabinet for any extended periods of time.

## 7.2. TROUBLESHOOTING

Symptom	Possible Cause	Remedy
No picture is displayed	<ol style="list-style-type: none"> <li>1. The power cord is disconnected.</li> <li>2. The main power switch on the back of the display is not switched on.</li> <li>3. The selected input has no connection.</li> <li>4. The display is in standby mode with VGA.</li> </ol>	<ol style="list-style-type: none"> <li>1. Plug in the power cord.</li> <li>2. Make sure the power switch is switched on.</li> <li>3. Connect a signal connection to the display.</li> </ol>
Interference displayed on the display or audible noise is heard	Caused by surrounding electrical appliances, traffic or fluorescent lights.	Move the display to another location to see if the interference is reduced.
Color is abnormal	The signal cable is not connected properly.	Make sure that the signal cable is attached firmly to the back of the display.
Picture is distorted with abnormal patterns	<ol style="list-style-type: none"> <li>1. The signal cable is not connected properly.</li> <li>2. The input signal is beyond the capabilities of the display.</li> </ol>	<ol style="list-style-type: none"> <li>1. Make sure that the signal cable is attached firmly.</li> <li>2. Check the video signal source to see if it is beyond the range of the display. Please verify its specifications with this display's specification section.</li> </ol>
Display image doesn't fill up the full size of the screen	The zoom mode is not correctly set.	Use the <b>Zoom mode</b> or <b>Custom zoom</b> function in the <b>Screen</b> menu to fine-tune display geometry and time frequency parameter.
Can hear sound, but no picture	Improperly connected source signal cable.	Make sure that both video inputs and sound inputs are correctly connected.
Can see picture but no sound is heard	<ol style="list-style-type: none"> <li>1. Improperly connected source signal cable.</li> <li>2. Volume is turned all the way down.</li> <li>3. <b>Mute</b> is turned on.</li> <li>4. No external speaker connected.</li> </ol>	<ol style="list-style-type: none"> <li>1. Make sure that both video and sound inputs are correctly connected.</li> <li>2. Use <b>VOL UP/VOL DOWN</b> button to hear sound.</li> <li>3. Switch <b>Mute</b> off by using the <b>MUTE</b> button.</li> <li>4. Connect external speakers and adjust the volume to a suitable level.</li> </ol>
Some picture elements do not light up	Some pixels of the display may not turn on.	This display is manufactured using an extremely high level of precision technology: however, sometimes some pixels of the display may not display. This is not a malfunction.
After-Images can still be seen on the screen after the display is powered off. (Examples of still pictures include logos, video games, computer images, and images displayed in 4:3 normal mode)	A still picture is displayed for an over extended period of time	Do not allow a still image to be displayed for an extended period of time as this can cause a permanent after-image to remain on the display. Refer to 4.2.4.Configuration I MENU for further details.

## 8. TECHNICAL SPECIFICATIONS

### Display

Item	Specifications
Screen size	46.9" (119.2 cm)
Viewable size	1068.0 (H) x 613.2 (V) mm/42.0 (H) x 24.1.0 (V) inch
Aspect ratio	16:9
Number of pixels	1920 (H) x 1080 (V)
Pixel pitch	0.5415 (H) x 0.5415 (V) mm
Displayable colors	1.07 billion colors
Brightness	700 cd/m <sup>2</sup>
Smart contrast	10000:1
Contrast ratio (typical)	3000:1
Viewing angle	178 degrees
Response time	Typ. 9 msec, Max.15 msec
Color gamut	72%
Frequency	Horizontal: 65/67.5 - 70 KHz Vertical: 57/60-63 Hz
Pixel clock	70~77 MHz

### Input Terminals

Item	Specifications
Audio Input	RCA Jack x 2 0.5V [rms] (Normal)/2 Channel (L+R)
RS-232C Input	D-Sub Jack x 1 (9 pin) TXD + RXD (1:1)
HDMI Input	HDMI Jack x 1 (Type A) Version 1.3 Digital RGB: TMDS (Video + Audio) MAX: Video - 720p, 1080p, 1920 x 1080/60 Hz (WUXGA) Audio - 48 KHz/ 2 Channel (L+R)
DVI-D Input	DVI-I jack Digital RGB: TMDS (Video)
VGA Input	D-Sub Jack x 1 (15 pin) Analog RGB: 0.7V [p-p] (75Ω), H/CS/V: TTL (2.2kΩ), SOG: 1V [p-p] (75Ω) MAX: 720p, 1080p, 1920 x 1080/60 Hz (WUXGA)
	3.5mm Mini-jack x 1 Audio: 0.5V [rms] (Normal)/2 Channel (L+R)
Component Input	BNC Jack x 1 Y: 1V [p-p] (75Ω), Pb: 0.7V [p-p] (75Ω), Pr: 0.7V [p-p] (75Ω) MAX: 480i, 576i, 480p, 576p, 720p, 1080i, 1080p
DisplayPort Input	DisplayPort Jack x 1 Version 1.1a, Digital TMDS
IR Input	Jack Audio Green/Blue D3.6 ST Digital Signal
PC audio Input	Jack Audio Analog Signal

### Control Terminals

Item	Specifications
USB	SKT USB2.0 A RT4P Digital Signal
RJ-45	Jack RJ-45 W/LED 1 Digital Signal

**Output Terminals**

Item		Specifications
Speaker Output		12W (L) + 12W (R) [RMS]/8Ω 1 Way 1 Speaker System 82 dB/W/M/160 Hz~13 KHz
Audio Output	RCA Jack x 1	0.5V [rms] (Normal)/ 2 Channel (L+R)
RS-232C Output	D-Sub Jack x 1 (9 pin)	TXD + RXD (1:1)
DVI-D Output	DVI-I jack	Digital RGB: TMDS (Video)
VGA Output	D-Sub Jack x 1 (15 pin)	Analog RGB: 0.7V [p-p] (75Ω), H/CS/V: TTL (2.2kΩ), SOG: 1V [p-p] (75Ω) MAX: 720p, 1080p, 1920 x 1080/60 Hz (WUXGA)
IR Output	Jack Audio Green/Blue D3.6 ST	Digital Signal

**General**

Item		Specifications
Power Supply		AC 100V ~ 240V, 50-60 Hz
Power Consumption (Max)		340W
Display Dimension [W x H x D] Without Stand (mm/inch)		1083.8 x 629.0 x 124.0/42.7 x 24.8 x 4.9
Gross Weight (kg/lbs)		34/75.0
Net Weight (kg/lbs)		29/63.9
Regulatory		CB, UL/cUL, EMC (CE/FCC/ICES003), Erp, E-Star, GOST, WEEE
Accessories		CD user's manual, QSG, Power cord, VGA cable, BNC-to-RCA adapter (x3), Cable retainer (x3), Remote control with batteries, Main switch cover

**Environmental Condition**

Item		Specifications
Temperature	Operational	0 ~ 40°C/32 ~ 104°F
	Storage	-20 ~ 60°C/ -3.99 ~ 140°F
Humidity	Operational	10 ~ 90% RH (No condensation)
	Storage	10 ~ 90% RH (No condensation)
Pressure	Operational	800 ~ 1100 hPa (Altitude: 0 ~ 4,000 m)
	Storage / Shipment	700 ~ 1100 hPa (Altitude: 0 ~ 15,000 m)

**Internal Speaker**

Item		Specifications
Type		R/L Speaker
Input		12 W (RMS)
Impedance		8Ω
Output Sound Pressure		82 dB/W/M
Frequency Response		80 Hz ~ 20 KHz

Note: Technical specifications are subject to change without notice

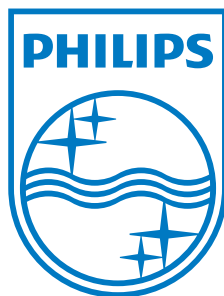

2012 © Koninklijke Philips Electronics N.V. All rights reserved.

Philips and the Philips Shield Emblem are registered trade marks of Koninklijke Philips Electronics N.V. and are used under license from Koninklijke Philips Electronics N.V.

Specifications are subject to change without notice.

[RETURN TO THE CONTENTS](#)