

Register your product and get support at
www.philips.com/welcome

English

231T1L



EN User Manual

PHILIPS



Country	Code	Telephone number	Tariff
Austria	+43	0810 000206	€ 0.07
Belgium	+32	078 250851	€ 0.06
Denmark	+45	3525 8761	Local call tariff
Finland	+358	09 2290 1908	Local call tariff
France	+33	082161 1658	€ 0.09
Germany	+49	01803 386 853	€ 0.09
Greece	+30	00800 3122 1223	Free of charge
Ireland	+353	01 601 1161	Local call tariff
Italy	+39	840 320 041	€ 0.08
Luxembourg	+352	26 84 30 00	Local call tariff
The Netherlands	+31	0900 0400 063	€ 0.10
Norway	+47	2270 8250	Local call tariff
Poland	+48	0223491505	Local call tariff
Portugal	+351	2 1359 1440	Local call tariff
Spain	+34	902 888 785	€ 0.10
Sweden	+46	08 632 0016	Local call tariff
Switzerland	+41	02 2310 2116	Local call tariff
United Kingdom	+44	0207 949 0069	Local call tariff

Contents

1. Notice	2	8. Feature setting highlights	21
		Using the Teletext	21
2. Important	4	Using the EPG	22
The most updated user manual on line	5	Parental Menu setting	22
		Channel Block	22
3. Get started and connect your devices	6	Parental Guidance	23
Back connector	6	Input Block	23
Side connector	8	Set Password	24
		Clean All	24
4. Controls	9	OAD update	24
Front and side controls	9		
Remote control	9	9. Pixel policy	24
5. Start to use	12	10. Troubleshooting	27
Switch your TV on/off or to standby	12	General TV issues	27
Switch channels	12	TV channel issues	27
Watch connected devices	13	Picture issues	27
Adjust TV volume	13	Sound issues	28
		HDMI connection issues	28
6. Product information	14	Computer connection issues	28
Supported display resolutions	14	Others	28
Tuner/Reception/Transmission	14	Contact us	28
Remote control	14		
Power	14		
Supported TV mounts	14		
7. TV/Channel settings	15		
Using TV signal as the input source.	15		
To adjust the country for auto tuning	15		
Audio Carrier(Analog TV only)	15		
1st Audio and 2nd Audio (Digital TV only)	16		
Channel Scan	16		
Update Scan	17		
Single RF Scan (Digital TV only)	17		
Analog Manual Scan (Analog TV only)	18		
Channel Skip	18		
Channel Sort (Swap)	19		
Channel Edit	19		
Decoder (Analog TV only)	20		
Analog Ch Fine Tune (Analog TV only)	20		
Appendix	20		

1. Notice

2011 © Koninklijke Philips Electronics N.V. All rights reserved.

Specifications are subject to change without notice. Trademarks are the property of Koninklijke Philips Electronics N.V or their respective owners. Philips reserves the right to change products at any time without being obliged to adjust earlier supplies accordingly. The material in this manual is believed adequate for the intended use of the system. If the product, or its individual modules or procedures, are used for purposes other than those specified herein, confirmation of their validity and suitability must be obtained. Philips warrants that the material itself does not infringe any United States patents. No further warranty is expressed or implied.

Warranty

- Risk of injury, damage to TV or void of warranty! Never attempt to repair the TV yourself.
- Use the TV and accessories only as intended by the manufacturer.
- The caution sign printed on the back of the TV indicates risk of electric shock. Never remove the TV cover. Always contact Philips Customer Support for service or repairs.



- Any operation expressly prohibited in this manual, or any adjustments and assembly procedures not recommended or authorised in this manual shall void the warranty.

Pixel characteristics

This LCD product has a high number of colour pixels. Although it has effective pixels of 99.999% or more, black dots or bright points of light (red, green or blue) may appear constantly on the screen. This is a structural property of the display (within common industry standards) and is not a malfunction.

Mains fuse (UK only)

This TV is fitted with an approved moulded plug. Should it become necessary to replace the mains fuse, this must be replaced with a fuse of the same value as indicated on the plug (example 10A).

- 1 Remove fuse cover and fuse.
- 2 The replacement fuse must comply with BS 1362 and have the ASTA approval mark. If the fuse is lost, contact your dealer in order to verify the correct type.
- 3 Refit the fuse cover.
In order to maintain conformity to the EMC directive, the mains plug on this product must not be detached from the mains cord cable.

Copyright



VESA, FDMI and the VESA Mounting Compliant logo are trademarks of the Video Electronics Standards Association.

® Kensington and Micro Saver are registered US trademarks of ACCO World Corporation with issued registrations and pending applications in other countries throughout the world.



Manufactured under license from Dolby Laboratories. Dolby and double-D symbol are trademarks of Dolby Laboratories.

2. Important

Read and understand all instructions before you use your TV. If damage is caused by failure to follow instructions, the warranty does not apply.

Safety

- Risk of electric shock or fire!
 - Never expose the TV to rain or water. Never place liquid containers, such as vases, near the TV. If liquids are spilt on or into the TV, disconnect the TV from the power outlet immediately. Contact Philips Consumer Care to have the TV checked before use.
 - Never place the TV, remote control or batteries near naked flames or other heat sources, including direct sunlight.
To prevent the spread of fire, keep candles or other flames away from the TV, remote control and batteries at all times.
- 
- Never insert objects into the ventilation slots or other openings on the TV.
 - When the TV is swivelled ensure that no strain is exerted on the power cord. Strain on the power cord can loosen connections and cause arcing.
 - Risk of short circuit or fire!
 - Never expose the remote control or batteries to rain, water or excessive heat.
 - Avoid force coming onto power plugs. Loose power plugs can cause arcing or fire.
 - Risk of injury or damage to the TV!
 - Two people are required to lift and carry a TV that weights more than 25 kg.
- When stand mounting the TV, use only the supplied stand. Secure the stand to the TV tightly. Place the TV on a flat, level surface that can support the combined weight of the TV and the stand.
 - When wall mounting the TV, use only a wall mount that can support the weight of the TV. Secure the wall mount to a wall that can support the combined weight of the TV and wall mount. Koninklijke Philips Electronics N.V. bears no responsibility for improper wall mounting that result in accident, injury or damage.
 - Risk of injury to children! Follow these precautions to prevent the TV from toppling over and causing injury to children:
 - Never place the TV on a surface covered by a cloth or other material that can be pulled away.
 - Ensure that no part of the TV hangs over the edge of the surface.
 - Never place the TV on tall furniture (such as a bookcase) without anchoring both the furniture and TV to the wall or a suitable support.
 - Educate children about the dangers of climbing on furniture to reach the TV.
 - Risk of overheating! Never install the TV in a confined space. Always leave a space of at least 4 inches around the TV for ventilation. Ensure curtains or other objects never cover the ventilation slots on the TV.
 - Risk of damage to the TV! Before you connect the TV to the power outlet, ensure that the power voltage matches the value printed on the back of the TV. Never connect the TV to the power outlet if the voltage is different.
 - Risk of injury, fire or power cord damage! Never place the TV or any objects on the power cord.
 - To easily disconnect the TV power cord from the power outlet, ensure that you have full access to the power cord at all times.
 - When you disconnect the power cord, always pull the plug, never the cable.

- Disconnect the TV from the power outlet and aerial before lightning storms. During lightning storms, never touch any part of the TV, power cord or aerial cable.
- Risk of hearing damage! Avoid using earphones or headphones at high volumes or for prolonged periods of time.
- If the TV is transported in temperatures below 5°C, unpack the TV and wait until the TV temperature matches room temperature before connecting the TV to the power outlet.



Never dispose of your product with other household waste. Please inform yourself about the local rules on the separate collection of electrical and electronic products. The correct disposal of your old product helps prevent potentially negative consequences for the environment and human health.

Your product contains batteries covered by the European Directive 2006/66/EC, which cannot be disposed of with normal household waste.

Please inform yourself about the local rules on the separate collection of batteries. The correct disposal of batteries helps prevent potentially negative consequences for the environment and human health.

Screen care

- Avoid stationary images as much as possible. Stationary images are images that remain on-screen for extended periods of time. Examples include: on-screen menus, black bars and time displays. If you must use stationary images, reduce screen contrast and brightness to avoid screen damage.
- Unplug the TV before cleaning.
- Clean the TV and frame with a soft, damp cloth. Never use substances such as alcohol, chemicals or household cleaners on the TV.
- Risk of damage to the TV screen! Never touch, push, rub or strike the screen with any object.
- To avoid deformations and colour fading, wipe off water drops as soon as possible.

The most updated user manual on line

The contents of the user manual are subject to change. Please refer to www.philips.com/support for the most updated user manual info reference.

Recycling



Your product is designed and manufactured with high quality materials and components, which can be recycled and reused.

When you see the crossed-out wheeled bin symbol attached to a product, it means the product is covered by the European Directive 2002/96/EC:

3. Get started and connect your devices

Congratulations on your purchase, and welcome to Philips! To fully benefit from the support that Philips offers, register your product at www.philips.com/welcome.

This section describes how to connect various devices with different connectors and supplements examples provided in the Quick Start.

Note

- Different types of connectors may be used to connect a device to your TV, depending on availability and your needs.

Back connector

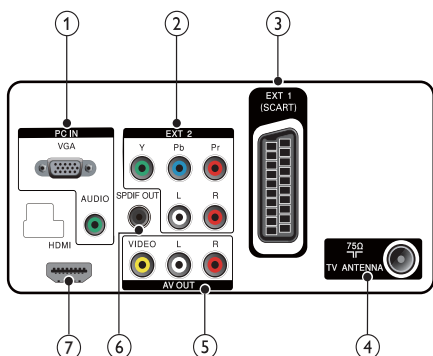

- 1 PC IN (VGA and AUDIO IN)**
Audio and video input from a computer.

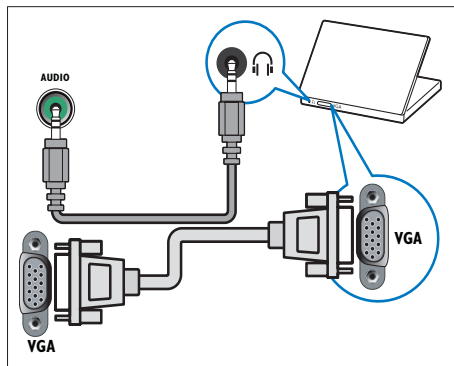

- 2 EXT 2 (Y Pb Pr and AUDIO L/R)**
Analogue audio and video input from analogue or digital devices such as DVD players or game consoles.

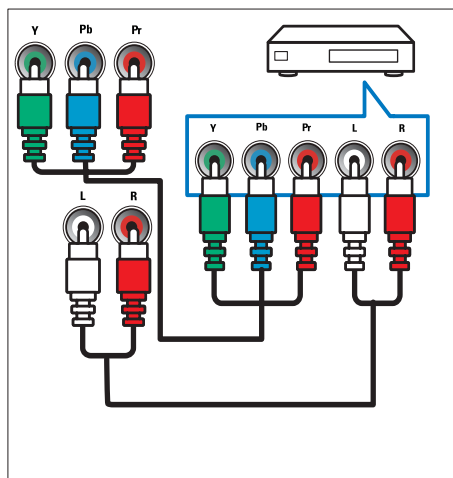

③ EXT 1 (SCART)

Analogue audio and video input from analogue or digital devices such as DVD players or game consoles.

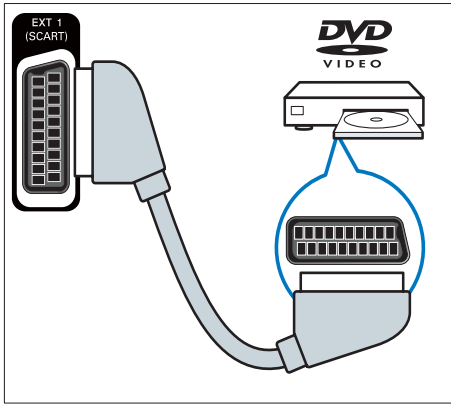

④ TV ANTENNA

Signal input from an antenna, cable or satellite.

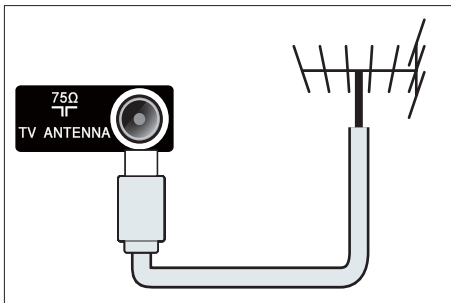

⑤ AV OUT (VIDEO OUT and AUDIO OUT L/R)

Audio and video output to analogue devices such as another TV or a recording device.

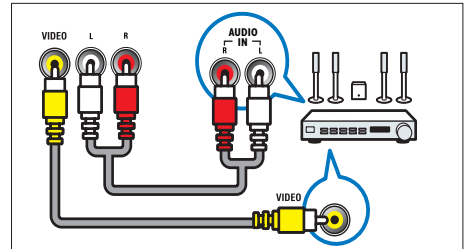

⑥ SPDIF OUT

Digital audio output to home theatres and other digital audio systems.

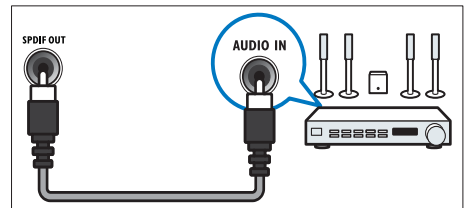

⑦ HDMI

Digital audio and video input from high-definition digital devices such as Blu-ray players.

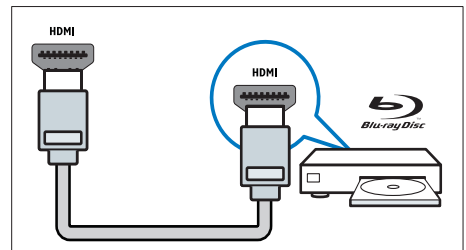

Connections via DVI or VGA require an additional audio cable.

Side connector

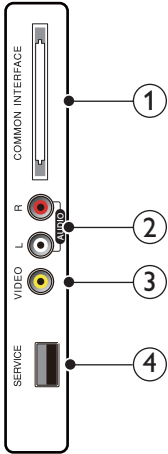

- ① **COMMON INTERFACE**
Slot for a Conditional Access Module (CAM).

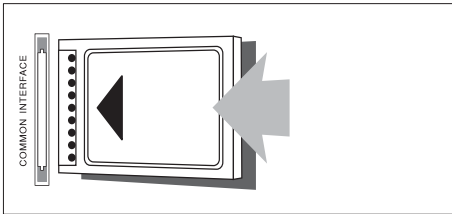

- ② **AUDIO L/R**
Audio input from analogue devices connected to VIDEO.

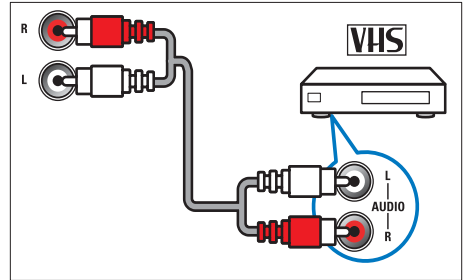

- ③ **VIDEO**
Composite video input from analogue devices such as VCRs.

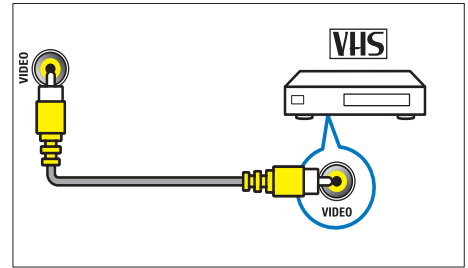

- ④ **SERVICE**
USB port, for upgrade firmware purpose only.

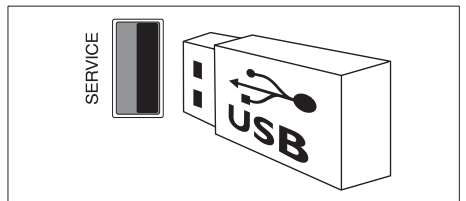

4. Controls

Front and side controls

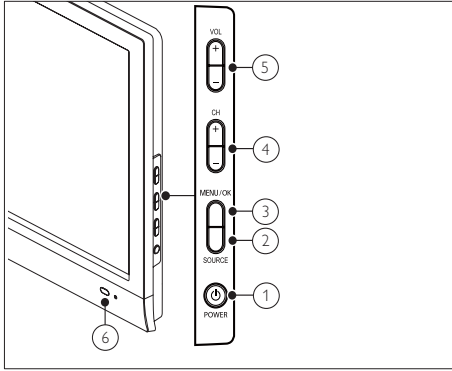

- ① **POWER:** Switches the TV on or off. The TV is not powered off completely unless it is physically unplugged.
- ② **SOURCE:** Selects connected devices.
- ③ **MENU/OK :** Displays the on-screen menu and confirms a selection in menus.
- ④ **CH +/-:** Switches to the next or previous channel.
- ⑤ **VOL +/-:** Increases or decreases volume.
- ⑥ **Power indicator :**
 Red LED: In standby mode or off.
 Green LED: Power on.

Remote control

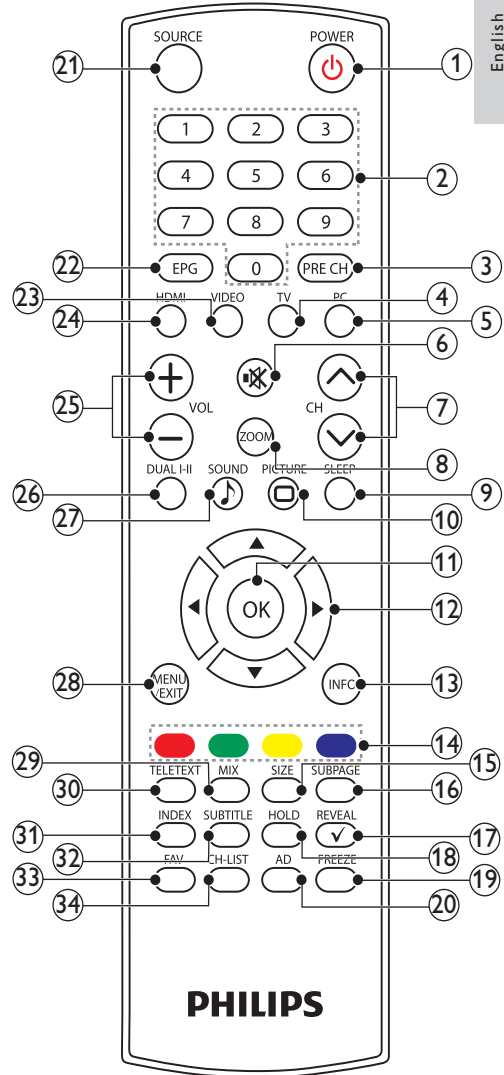

- ① **⏻ (Standby-On)**
- Switch the TV to standby if the TV is on.
 - Switch the TV on if the TV is in standby.
- ② **0-9 (Numeric buttons)**
Select a channel or setting.
- ③ **PRE CH**
Return to the previously viewed channel.
- ④ **TV**
Press to choose TV mode.
- ⑤ **PC**
Press to choose PC mode.
- ⑥ **🔇 (Mute)**
Switch the sound On or Off.
- ⑦ **CH \wedge / V (Channel \wedge / V)**
Switch to the next or previous channel.
- ⑧ **ZOOM**
Toggle among screen formats.
- ⑨ **SLEEP**
Toggle to select the preset time to switch the TV to standby mode automatically.
- ⑩ **PICTURE**
Toggle to select the Smart Picture setting.
- ⑪ **OK**
Confirm an entry or selection and display the channel grid, when watching TV.
- ⑫ **▲ ▼ ◀ ▶ (Navigation buttons)**
Navigate through the menus.
- ⑬ **INFO**
Display or hide the information screen about the selected channel.
- ⑭ **Colour buttons**
Select tasks or options.
- ⑮ **SIZE**
Toggle to change the font size in Teletext mode. (Full screen / Top half / Bottom half)
- ⑯ **SUBPAGE**
Display the sub page when the Teletext information has more than one page.
- ⑰ **REVEAL**
Reveal hidden information of Teletext.
- ⑱ **HOLD**
Toggle to stop the scrolling of pages to stop the text decoder receiving data.
- ⑲ **FREEZE**
Press to freeze the TV picture.
- ⑳ **AD (Audio Description) (For RF Digital TV only)**
UK only: Enables audio commentary for the visually handicapped.
- ㉑ **SOURCE**
Select connected devices.
- ㉒ **EPG**
Switch the Electronic Programme Guide On or Off.
- ㉓ **VIDEO**
Press to switch to VIDEO YPbPr / Composite /SCART mode.
- ㉔ **HDMI**
Press to switch to HDMI mode.
- ㉕ **VOL +/-**
Increase or decrease the volume.
- ㉖ **DUAL I-II**
Toggle to select mono / stereo / dual I / dual II from TV RF input.
- ㉗ **🎵 SOUND**
Toggle to select the Smartsound Mode.
- ㉘ **MENU/EXIT**
Press to open or close the on-screen menu.
- ㉙ **MIX**
Press to overlay the Teletext page on the TV picture.
- ㉚ **TELETEXT**
Press to open or close the Teletext.

- ③① **INDEX**
Press to display the index page of Teletext.
- ③② **SUBTITLE**
- In TV mode: Press to turn the subtitle on or off.
 - In Text mode: Press to open the subtitle page.
- ③③ **FAV**
Press to display the Favourite List.
- ③④ **CH-LIST**
Press to display the Channel List.

5. Start to use

This section helps you perform basic TV operations.

Switch your TV on/off or to standby

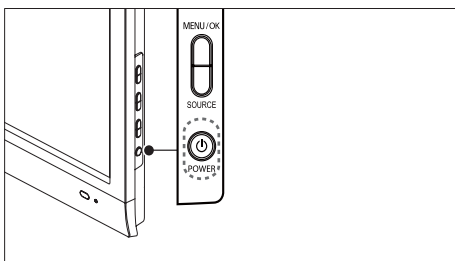
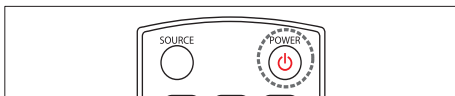

To switch on

- If the standby indicator is off, press **POWER** at the side of the TV.
- If the standby indicator is red, press **Standby-On** on the remote control.

To switch to standby

- Press **Standby-On** on the remote control.
↳ The standby indicator switches to red.

To switch off

- Press **POWER** at the side of the TV.
↳ The standby indicator switches off.



Tip

- Though your TV consumes very little power when in standby, energy continues to be consumed. When not in use for an extended period of time, disconnect the TV power cable from the power outlet.

Note

- If you cannot locate your remote control and want to switch on the TV from standby, press **CH +/-** at the side of the TV.

Switch channels

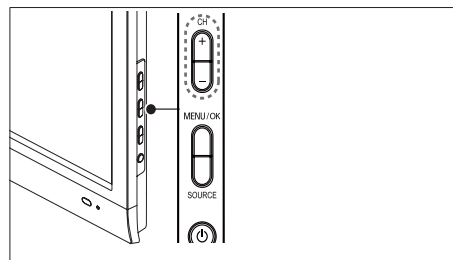
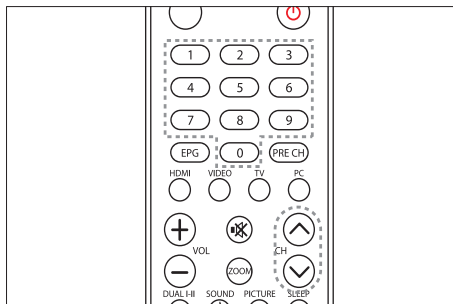

- Press **CH +/-** on the remote control or **CH +/-** on the side of the TV.
- Enter a channel number using the **Numeric buttons**.
- Use the channel grid.

Note

- When you use a favourite list, you can only select those channels in the list.

Watch connected devices

Note

- Switch on the device before selecting it as a source on the TV.

Use the source button

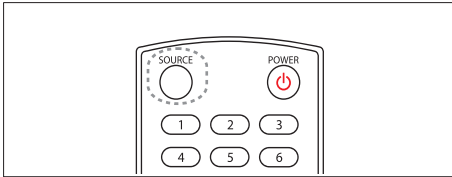

- 1 Press **SOURCE**.
↳ The source list appears.
- 2 Press the **SOURCE**, ▲ or ▼ buttons to select a device.
- 3 Press **OK** to confirm your choice.
↳ The sTV switches to the selected device.
↳ The TV switches to the selected device.

Adjust TV volume

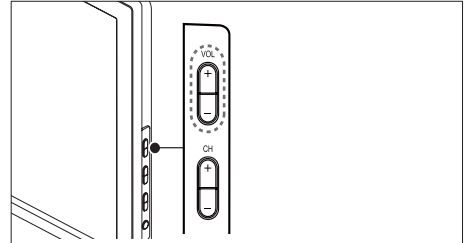
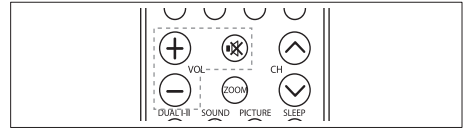

To increase or decrease volume

- Press **VOL +/-** on the remote control.
- Press **VOL +/-** on the side of the TV.

To mute or unmute sound

- Press **MUTE** to mute the sound.
- Press **MUTE** again to restore the sound.

6. Product information

Product information is subject to change without notice. For detailed product information, go to www.philips.com/support.

Supported display resolutions

Computer formats

- Resolution - refresh rate:
 - 640 × 480 - 60Hz
 - 640 × 480 - 75Hz
 - 800 × 600 - 60Hz
 - 800 × 600 - 75Hz
 - 1024 × 768 - 60Hz
 - 1024 × 768 - 75Hz
 - 1280 × 1024 - 60Hz
 - 1440 × 900 - 60Hz
 - 1600 × 900 - 60Hz
 - 1680 × 1050 - 60Hz
 - 1920 × 1080 - 60Hz_RB (the best for 231T1L)

Video formats

- Resolution - refresh rate:
 - 480i - 60Hz
 - 480p - 60Hz
 - 576i - 50Hz
 - 576p - 50Hz
 - 720p - 50Hz, 60Hz
 - 1080i - 50Hz, 60Hz
 - 1080p - 50Hz, 60Hz

Tuner/Reception/Transmission

- Antenna input: 75ohm coaxial (IEC75)
- DVB: DVB Terrestrial, DVB-T MPEG4
- TV system: DVB COFDM 2K/8K; PAL I, B/G, D/K; SECAM B/G, D/K, L/L'
- Video playback: NTSC, SECAM, PAL
- Tuner Bands: Hyperband, S-channel, UHF, VHF

Remote control

- Type: 231T1L RC
- Batteries: 2 × AAA (LR03 type)

Power

- Mains power: 100-240V, 50Hz
- Off mode power: < 0.5W
- Ambient temperature: 5 to 40 degrees Celsius

Supported TV mounts

To mount the TV, purchase a Philips TV mount or a VESA-compatible TV mount. To prevent damage to cables and connectors, be sure to leave a clearance of at least 5.5 cm from the back of the TV.



Warning

- Follow all instructions provided with the TV mount. Koninklijke Philips Electronics N.V. bears no responsibility for improper TV mounting that results in accident, injury or damage.

TV screen size (inches)	Required pitch (mm)	Required mounting bolts
23	100 × 100	4 × M4

7. TV/Channel settings

This chapter provides adjust the program related settings and the audio language related settings

Using TV signal as the input source.

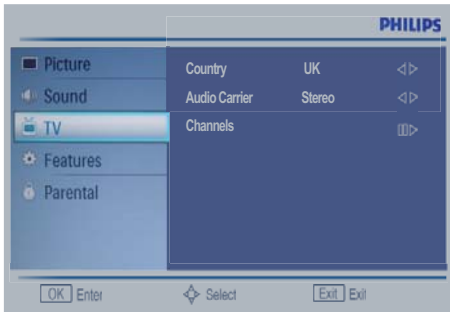

- ▶ Press MENU button to display the menu.
- ▶ Press ▲ / ▼ button to select the TV item.
- ▶ Press OK button enter the TV sub item.
- ▶ Press MENU button to exit the sub item.

To adjust the country for auto tuning

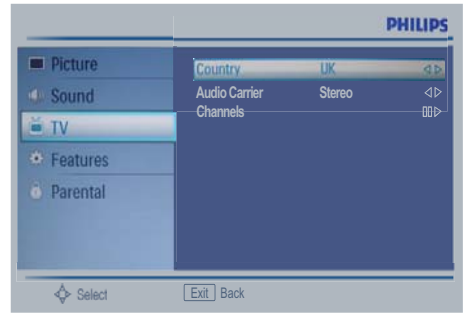

- ▶ Press MENU + ▲ / ▼ button to select TV.
- ▶ Press OK + ▲ / ▼ button to select Country.
- ▶ Press ◀ / ▶ button to select the item.

Audio Carrier(Analog TV only)

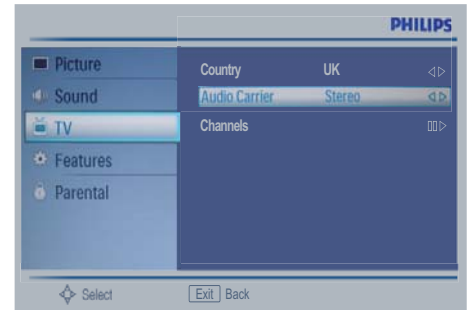

- ▶ Select Mono / Stereo / Dual I / Dual II ,for preference

Note

- if your preference is not the workable carrier, the default priority will be : Dual I > Dual II ;Stereo > Mono.

1st Audio and 2nd Audio (Digital TV only)

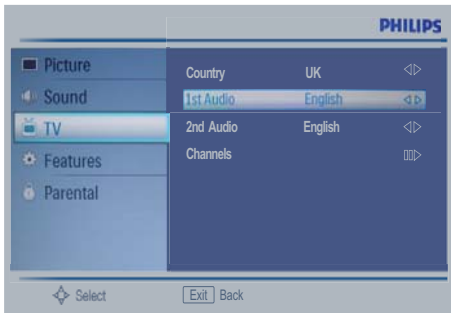

- The Audio function allows selection of a preferred language.
 - If audio data in a selected language is not broadcast, the default language audio will be played.
 - When the languages you selected as the primary for Audio Language are not supported, you can select language in secondary category.
- ▶ Press MENU + ▲ / ▼ button to select TV.
 - ▶ Press OK + ▲ / ▼ button to select 1st Audio and 2nd Audio.
 - ▶ Press ◀ / ▶ button to select the item.

Channel Scan

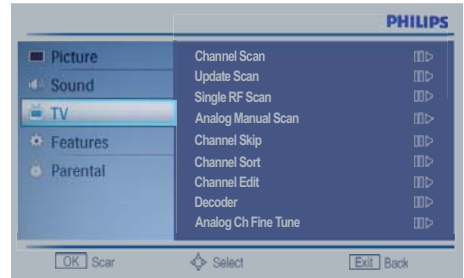

- Use this function to find and store all available channels automatically in both digital and analog mode.
- ▶ Press MENU + ▲ / ▼ button to select TV.
 - ▶ Press OK + ▲ / ▼ button to select Channels.
 - ▶ Press OK + ▲ / ▼ button to select Channel Scan.
 - ▶ Press OK button to execute the Channel Scan.

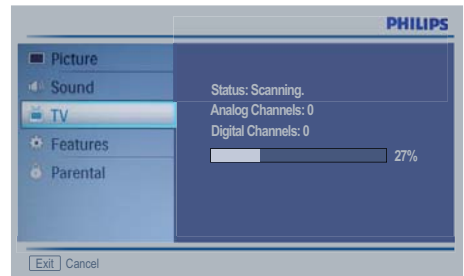

- ↳ Channel Scan scan both the digital and analog channels, first scan digital channels and analog channels last.
- ↳ Channel Scan will erase all old stored channels scanned by previous execution.
- ↳ Digital channel number will assign by LCN (Logical Channel Number) if LCN is exist.
- ↳ Digital channel which no LCN or LCN conflict will assign from 800 to 899.

- ↳ Analog channels will assign from 901 to 999, if have channel name, will assign from 901, others will assign by frequency,
- ↳ If can't scan any digital channels, only analog channels, will assign analog channel from 1.

Update Scan

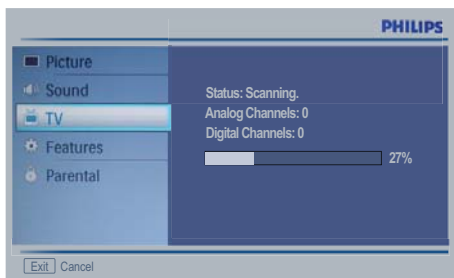

- To check if any new channel is available. Only new channels found will be stored, and original channels won't be overwritten.
- ▶ Press MENU + ▲ / ▼ button to select TV.
- ▶ Press OK + ▲ / ▼ button to select Channels.
- ▶ Press OK + ▲ / ▼ button to select Update Scan.
- ▶ Press OK button to execute the Update Scan.

Single RF Scan (Digital TV only)

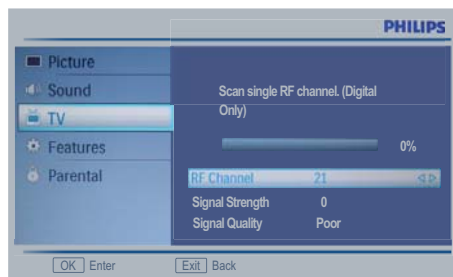

- Single RF Scan lets you manually add a digital channel to your channel list.
- ▶ Press MENU + ▲ / ▼ button to select TV.
- ▶ Press OK + ▲ / ▼ button to select Channels.
- ▶ Press OK + ▲ / ▼ button to select Single RF Scan.
- ▶ Press OK button to display the DTV or TV channel info.
- ▶ Press ◀ / ▶ button to change RF Channel.
- ▶ Press OK button to scan.

Analog Manual Scan (Analog TV only)

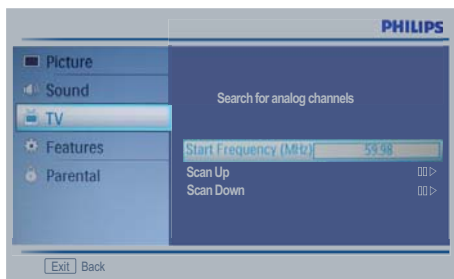

- Analog Manual Scan lets you manually add an analog channel to your channel list.
- ▶ Press MENU + ▲ / ▼ button to select TV.
- ▶ Press OK + ▲ / ▼ button to select Channels.
- ▶ Press OK + ▲ / ▼ button to select Analog Manual Scan.
- ▶ Press OK button to display the ATV or TV channel info.
- ▶ Press ▲ / ▼ button to select an item.
- ▶ Press OK / ► button to Scan Up or Down.

Channel Skip

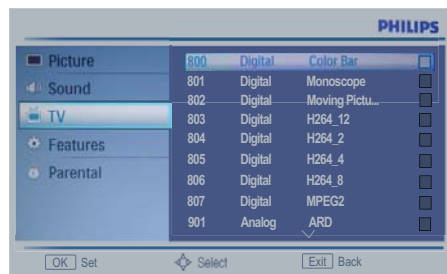

- This function enables you to skip the stored channels.
- ▶ Press MENU + ▲ / ▼ button to select TV.
- ▶ Press OK + ▲ / ▼ button to select Channels.
- ▶ Press OK + ▲ / ▼ button to select Channel Skip.
- ▶ Press OK + ▲ / ▼ button to select the channel you want to skip.
- ▶ Press OK button to set. A checked icon is a skip one.
- A skip channel is skipped when using CH ^ and CHv button to browse the channels.
- A skip channel can be watch by key-in the program number or select by list.
- No signal analog channel is a default skip program.

Channel Sort (Swap)

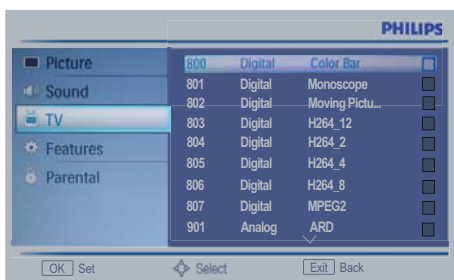
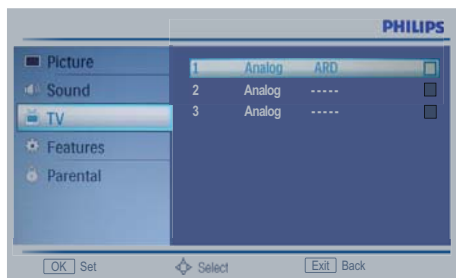

- To sort (swap) two channels.
 - ▶ Press MENU + ▲ / ▼ button to select TV.
 - ▶ Press OK + ▲ / ▼ button to select Channels.
 - ▶ Press OK + ▲ / ▼ button to select Channel Sort.
 - ▶ Press OK + ▲ / ▼ button to select the channel.
 - ▶ Press OK button to set. A checked icon displays.
 - ▶ Press ▲ / ▼ button to select another channel.
 - ▶ Press OK button to swap these two channels.

Channel Edit

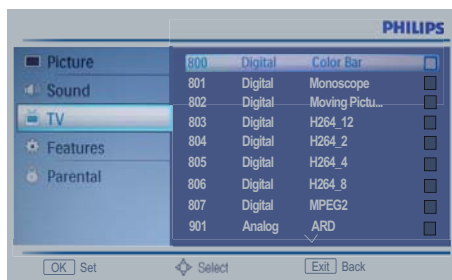

- To edit a channel number and name of a channel.
 - ▶ Press MENU + ▲ / ▼ button to select TV.
 - ▶ Press OK + ▲ / ▼ button to select Channels.
 - ▶ Press OK + ▲ / ▼ button to select Channel Edit.
 - ▶ Press OK + ▲ / ▼ button to select the channel.
 - ▶ Press OK button to display the change dialog.

Decoder (Analog TV only)

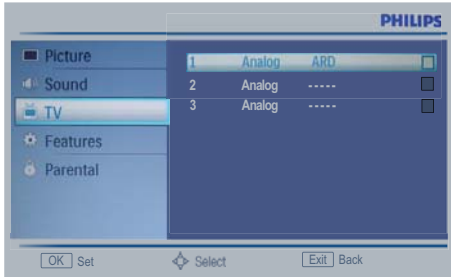

- To edit a channel decode.
 - ▶ Press MENU + ▲ / ▼ button to select TV.
 - ▶ Press OK + ▲ / ▼ button to select Channels.
 - ▶ Press OK + ▲ / ▼ button to select Decoder.
 - ▶ Press OK + ▲ / ▼ button to select the channel.
 - ▶ Press OK button to set. A checked icon displays.

- ▶ Press OK + ▲ / ▼ button to select Analog Ch Fine Tune.
- ▶ Press OK + ▲ / ▼ button to select the channel you want to fine tune.
- ▶ Press OK button to the Fine Tune dialogue.
- ▶ Press ◀ / ▶ to fine tune the frequency.
- ▶ Press OK button to save.

Appendix

Alphabet and numeric numbers mapping table on the Remote control

- To edit a channel number and name of a channel via the Remote control:

0: .@0
1: _ - 1
2: ABCabc2
3: DEFdef3
4: GHIghi4
5: JKLjkl5
6: MNomno6
7: PQRSpqrs7
8: TUVtuv8
9: WXYZwxyz9

Analog Ch Fine Tune (Analog TV only)

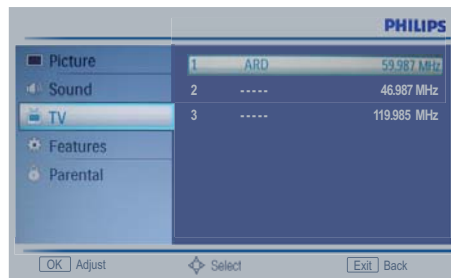

- Normally fine tuning is only necessary if reception is poor.
 - ▶ Press MENU + ▲ / ▼ button to select TV.
 - ▶ Press OK + ▲ / ▼ button to select Channels.

8. Feature setting highlights

Menu Features page provides Menu Language, Picture format, Time, Subtitle, Teletext Language, Common Interface, and Reset Default.

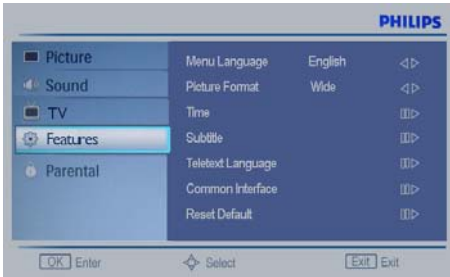

- ▶ Press MENU button to display the menu.
- ▶ Press ▲ / ▼ button to select the Features item.
- ▶ Press OK button enter the Features sub item.
- ▶ Press MENU button to exit the sub item.

Using the Teletext

If the channel support Teletext mode (means Teletext is provided), user can open the page to watch some information. Support Teletext 1.5.

Teletext contents follow broadcast contents, change Country will not affect the Teletext contents.

Teletext display full screen.

Teletext page number show in left-up corner, if have several subpage, will show in up line, current subpage number show in right-up corner.

The key teletext button will be handled by Teletext and MHEG5 component. In MHEG5, when "no teletext" is transmitted, it depends on MHEG 5 application – normally it displays

nothing. Teletext is compliant with MHEG5 behavior; it will not show "No Teletext" when country is U.K.



To display Teletext.	Press the TELETEXT button.
To change the Teletext page.	Press the ▲ / ▼ button.
To change the Teletext subpage.	Press the SUBPAGE, and number button.
To stop the automatic page change.	Press the HOLD button.
To return to the Teletext index page.	Press the INDEX button.
To reveal the Teletext information.	Press the REVEAL button.
To display the Teletext subtitle.	Press the SUBTITLE button.
To change different Teletext content.	Press the one of four buttons. 
	Color key priority: TOP > FLOF > Favorite page > Default color key.

Using the EPG

This system has an Electronic Program Guide (EPG) to help your navigation through all the possible viewing options.

The EPG supplies information such as program listings, start and end times for all available services. In addition, detailed information about the program is often available in the EPG (the availability and amount of these program details will vary, depending on the particular broadcaster).

This function can be used only when the EPG information is broadcasted by broadcasting companies.



- ▶ Press the EPG button to display the EPG. The functions of color keys are optional.

Note

- Can't display EPG when TV channel is Analog channel.

Parental Menu setting

Menu Parental page provides Channel Block, Parental Guidance, Set Password and Key Lock settings.

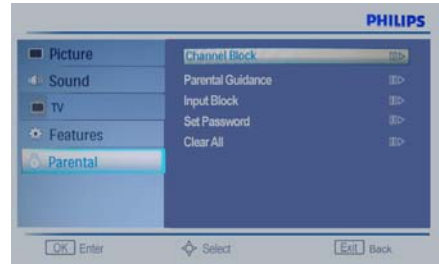



- ▶ Press MENU button to display the menu.
- ▶ Press ▲ / ▼ button to select the Parental item.
- ▶ Press OK button enter the Parental sub item.
- ▶ Press number 0-9 button to key-in the correct password to select the sub item. (The default password is 0000.)
- ▶ Press MENU button to exit the sub item.

Channel Block

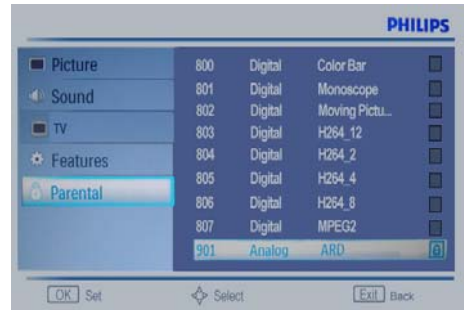
- Blocks any channels that you do not want to watch or that you do not want your children to watch



- Default value is non-block.
- Channel with a lock icon  is a blocked channel.
- A blocked channel can be un-locked temporarily after key-in the correct password.
- ▶ Press the OK button to display the password dialog.
- ▶ Press the 0-9 buttons to key-in the correct password.
- All locked channels and input source will temporarily un-lock.

- After powering off and on the TV set, the un-locked channels will be locked again.
- ▶ Press ▲ / ▼ button to select the channel.
- ▶ Press OK button to set. A checked channel  is a block one.
- When user not input password to un-lock any channels and input source, press OK button to lock/unlock the channel in Parental Menu, the screen will lock/unlock in real time.
- When user input correct password in the password dialog to temporarily un-locked, and not powering off and on the TV set, during this period, press OK button to lock/unlock the channel in Parental Menu, the screen will not lock/unlock in real time.

Parental Guidance





- ▶ This function operates according to information from the broadcasting station.
- ▶ Therefore if the signal has no this information, this function does not operate.
- ▶ Prevent children from watching adult's TV programs by the rating limit set.

Age Rating :

To adjust the age rating based on age: None, 4, 5, 6, 7, 8, 9, 10, 11, 12, 13, 14, 15, 16, 17 and 18.

Input Block



- To lock an input source.
 - Default value is non-block.
 - Input source with a lock icon  is a blocked input source.
 - A blocked input source can be un-locked temporarily after key-in the correct password.
 - ▶ Press the OK button to display the password dialog.
 - ▶ Press the 0-9 buttons to key-in the correct password.
- All input source and locked channels will temporarily un-lock
- After powering off and on the TV set, the un-locked input source will be locked again.
- ▶ Press ▲ / ▼ button to select the input source.
- ▶ Press OK button to set. A checked icon  is a block one.
 - When user not input password to un-lock any channels and input source, press OK button to lock/unlock the input source in Parental Menu, the screen will lock/unlock in real time.
 - When user input correct password in the password dialog to temporarily un-locked, and not powering off and on the TV set, during this period, press OK button to lock/unlock the input source in Parental Menu, the screen will not lock/unlock in real time.

Set Password

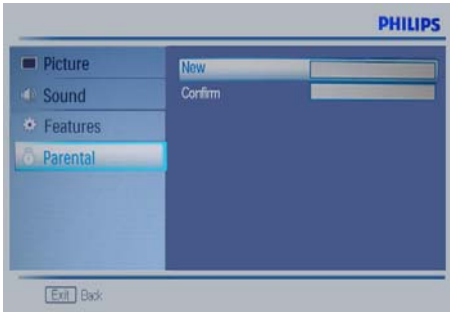

- To change the password.
- The default password is 0000.
- Input a 4-digit password. Be sure to remember this number!
- Re-enter new password for confirm.

Clean All

- To reset all parental control settings to the default values.
 - A confirm diagram displays before execute.

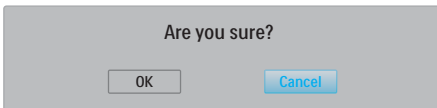

OAD update

If using digital broadcast, your TV would automatically receive software updates. When it is active, you will receive a message on your screen asking you to update your software. Just follow the instruction on the message to make your choice and complete the settings.

9. Pixel policy

Philips strives to deliver the highest quality products. We use some of the industry's most advanced manufacturing processes and practice stringent quality control. However, pixel or sub pixel defects on the TFT LCD panels used in flat panel monitors are sometimes unavoidable. No manufacturer can guarantee that all panels will be free from pixel defects, but Philips guarantees that any monitor with an unacceptable number of defects will be repaired or replaced under warranty. This notice explains the different types of pixel defects and defines acceptable defect levels for each type. In order to qualify for repair or replacement under warranty, the number of pixel defects on a TFT LCD panel must exceed these acceptable levels. For example, no more than 0.0004% of the sub pixels on a monitor may be defective. Furthermore, Philips sets even higher quality standards for certain types or combinations of pixel defects that are more noticeable than others. This policy is valid worldwide.

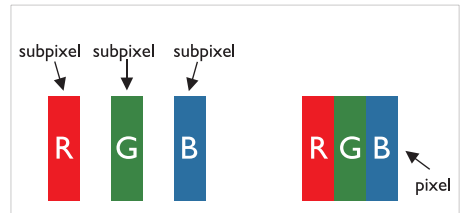

Pixels and Sub pixels

A pixel, or picture element, is composed of three sub pixels in the primary colors of red, green and blue. Many pixels together form an image. When all sub pixels of a pixel are lit, the three colored sub pixels together appear as a single white pixel. When all are dark, the three colored sub pixels together appear as a single black pixel. Other combinations of lit and dark sub pixels appear as single pixels of other colors.

Types of Pixel Defects

Pixel and sub pixel defects appear on the screen in different ways. There are two categories of pixel defects and several types of sub pixel defects within each category.

Bright Dot Defects Bright dot defects appear as pixels or sub pixels that are always lit or 'on'. That is, a bright dot is a sub-pixel that stands out on the screen when the monitor displays a dark pattern. There are the types of bright dot defects:

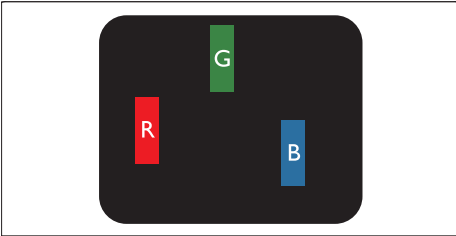

One lit red, green or blue sub pixel

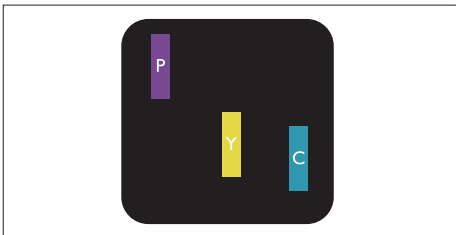

Two adjacent lit sub pixels:

- Red + Blue = Purple
- Red + Green = Yellow
- Green + Blue = Cyan (Light Blue)

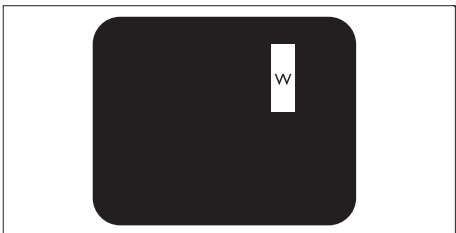

Three adjacent lit sub pixels (one white pixel)

Note

A red or blue bright dot must be more than 50 percent brighter than neighboring dots while a green bright dot is 30 percent brighter than neighboring dots.

Black Dot Defects Black dot defects appear as pixels or sub pixels that are always dark or 'off'. That is, a dark dot is a sub-pixel that stands out on the screen when the monitor displays a light pattern. These are the types of black dot defects:

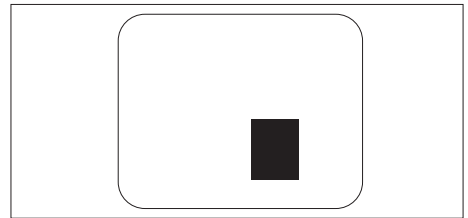
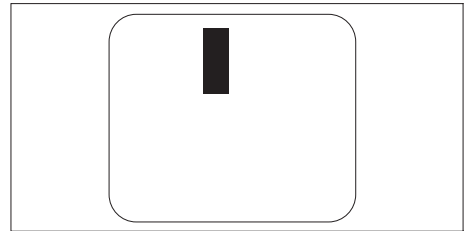

Proximity of Pixel Defects

Because pixel and sub pixels defects of the same type that are near to one another may be more noticeable, Philips also specifies tolerances for the proximity of pixel defects.

Pixel Defect Tolerances

In order to qualify for repair or replacement due to pixel defects during the warranty period, a TFT LCD panel in a Philips flat panel monitor must have pixel or sub pixel defects exceeding the tolerances listed in the following tables.

BRIGHT DOT DEFECTS	ACCEPTABLE LEVEL
MODEL	231T1L plus
1 lit subpixel	3
2 adjacent lit subpixels	1
3 adjacent lit subpixels (one white pixel)	0
Distance between two bright dot defects*	>15mm
Total bright dot defects of all types	3

BLACK DOT DEFECTS	ACCEPTABLE LEVEL
MODEL	231T1L plus
1 dark subpixel	5 or fewer
2 adjacent dark subpixels	2 or fewer
3 adjacent dark subpixels	0
Distance between two black dot defects*	>15mm
Total black dot defects of all types	5 or fewer

TOTAL DOT DEFECTS	ACCEPTABLE LEVEL
MODEL	231T1L plus
Total bright or black dot defects of all types	5 or fewer



Note

1 or 2 adjacent sub pixel defects = 1 dot defect

The monitor is ISO9241-307 compliant.

10. Troubleshooting

This section describes commonly encountered issues and accompanying solutions.

General TV issues

The TV does not switch on:

- Disconnect the power cable from the power outlet. Wait for one minute then reconnect it.
- Check that the power cable is securely connected.

The remote control is not working properly:

- Check that the remote control batteries are correctly inserted according to the +/- orientation.
- Replace the remote control batteries if they are flat or weak.
- Clean the remote control and TV sensor lens.

The standby light on the TV blinks red:

- Disconnect the power cable from the power outlet. Wait until the TV cools down before reconnecting the power cable. If the blinking reoccurs, contact Philips Consumer Care.

The TV menu is in the wrong language

- Change the TV menu to your preferred language.

When turning the TV on/off/to standby, you hear a creaking sound from the TV chassis:

- No action is required. The creaking sound is normal expansion and contraction of the TV as it cools and warms up. This does not impact performance.

TV channel issues

Previously installed channels do not appear in the channel list:

- Check that the correct channel list is selected.

No digital channels were found during the installation:

- Check that the TV supports DVB-T or DVB-C in your country. See the listed countries on the back of the TV.

Picture issues

The TV is on, but there is no picture:

- Check that the antenna is properly connected to the TV.
- Check that the correct device is selected as the TV source.

There is sound but no picture:

- Check that the picture settings are correctly set.

There is poor TV reception from an antenna connection:

- Check that the antenna is properly connected to the TV.
- Loud speakers, unearthed audio devices, neon lights, high buildings and other large objects can influence reception quality. If possible, try to improve the reception quality by changing the antenna direction or moving devices away from the TV.
- If reception on only one channel is poor, fine tune this channel.

There is poor picture quality from connected devices:

- Check that the devices are connected properly.
- Check that the picture settings are correctly set.

The TV did not save your picture settings:

- Check that the TV location is set to the home setting. This mode offers you the flexibility to change and save settings.

The picture does not fit the screen; it is too big or too small:

- Try using a different picture format.

The picture position is incorrect:

- Picture signals from some devices may not fit the screen correctly. Check the signal output of the device.

Sound issues

There is a picture but no sound from the TV:

Note

- If no audio signal is detected, the TV automatically switches the audio output off — this does not indicate malfunction.
- Check that all cables are properly connected.
- Check that the volume is not set to 0.
- Check that the sound is not muted.

There is a picture but the sound quality is poor:

- Check that the sound settings are correctly set.

There is a picture but sound comes from one speaker only:

- Verify that sound balance is set to the centre.

HDMI connection issues

There are problems with HDMI devices:

- Note that HDCP support can delay the time taken for a TV to display content from a HDMI device.
- If the TV does not recognise the HDMI device and no picture is displayed, try switching the source from one device to another and back again.
- If there are intermittent sound disruptions, check that output settings from the HDMI device are correct.
- If a HDMI-to-DVI adaptor or HDMI to DVI cable is used, check that an additional audio cable is connected to **AUDIO IN** (mini-jack only).

Computer connection issues

The computer display on the TV is not stable:

- Check that a supported resolution and refresh rate is selected on the computer.
- Set the TV picture format to unscaled.

Others

When should I use SmartContrast feature?

- SmartContrast feature is designed for enhancing movies as well as playing some games, as it enhances contrast ratio in dark moving scenes.
- Factory default is "Off"
- For office usage or internet applications it is recommended to turn SmartContrast "Off"

Power LED turn on for Auto program update

- In a case of auto s/w update, the unit will be turned on automatically for software updates. There will be no video or audio when doing the updates. The unit will also be returned to normal when software updates are completed.

Timing setting:

- Suggest do the time setting after scan TV channels to synchronize the time zone. This will facilitate any auto software updates being active in the right and designated time period provided by the TV broadcasting system makers.

Contact us

If you cannot resolve your problem, refer to the FAQs for this TV at www.philips.com/support.

If the problem remains unresolved, contact Philips Consumer Care in your country as listed in this User Manual.

 **Warning**

- Do not attempt to repair the TV yourself. This may cause severe injury, irreparable damage to your TV or void your warranty.

 **Note**

- Make a note of your TV model and serial number before you contact Philips. These numbers are printed on the back of the TV and on the packaging.

Version: M1DTVE3T

2011 © Koninklijke Philips Electronics N.V. All rights reserved.
Specifications are subject to change without notice.

Philips and the Philips Shield Emblem are registered trademarks of
Koninklijke Philips Electronics N.V. and are used under license from
Koninklijke Philips Electronics N.V."

www.philips.com

