

# SAMSUNG

# USER MANUAL

---

## Curved Monitor

CJ79\*

The color and the appearance may differ depending on the product, and the specifications are subject to change without prior notice to improve the performance.

The contents of this manual are subject to change without notice to improve quality.

Thunderbolt and the Thunderbolt logo are trademarks of Intel Corporation in the U.S. and/or other countries.

© Samsung Electronics

Samsung Electronics owns the copyright for this manual.

Use or reproduction of this manual in parts or entirety without the authorization of Samsung Electronics is prohibited.

Trademarks other than that of Samsung Electronics are owned by their respective owners.

- An administration fee may be charged if either
  - (a) an engineer is called out at your request and there is no defect in the product (i.e. where you have failed to read this user manual).
  - (b) you bring the unit to a repair center and there is no defect in the product (i.e. where you have failed to read this user manual).
- The amount of such administration charge will be advised to you before any work or home visit is carried out.

---

# Table of contents

## Before Using the Product

---

Securing the Installation Space	4
Precautions for storage	4

---

<b>Safety Precautions</b>	<b>4</b>
Cleaning	5
Electricity and Safety	5
Installation	6
Operation	7

## Preparations

---

<b>Parts</b>	<b>9</b>
Control Panel	9
Direct Key guide	10
Function Key Guide	11
Changing Brightness, Contrast and Eye Saver Mode settings	13
Changing the Volume setting	13
Types of Ports	14
Upgrading the Software via USB	15
Adjusting the Product Tilt and Height	16
Anti-theft Lock	17
Precautions for moving the monitor	17

---

<b>Installation</b>	<b>18</b>
Removing the Stand	18
Attaching the Wall-mount bracket	19
Attaching the Stand	20

## Connecting and Using a Source Device

---

Read below before installing the monitor.	21
---	----

---

<b>Connecting and Using a PC</b>	<b>21</b>
Connection Using the HDMI Cable	21
Connection Using an HDMI-DVI Cable	22
Connection Using a DP Cable	22
Connection Using a Thunderbolt™ 3 Cable or USB Type-C Cable	23
Connecting to Headphones	24
Connecting the Power	24

---

<b>Connecting the Product to a PC as a USB HUB</b>	<b>24</b>
Connecting a PC to the Product	24
Utilizing the Product as a USB HUB	25
Tidying Up the Connected Cables	26

---

<b>Correct posture to use the product</b>	<b>27</b>
---	-----------

---

<b>Driver Installation</b>	<b>27</b>
----------------------------	-----------

---

<b>Setting Optimum Resolution</b>	<b>27</b>
-----------------------------------	-----------

## Picture

---

SAMSUNG MAGIC Bright	28
----------------------	----

---

<b>Brightness</b>	<b>29</b>
-------------------	-----------

---

<b>Contrast</b>	<b>29</b>
-----------------	-----------

---

<b>Sharpness</b>	<b>29</b>
------------------	-----------

---

<b>Color</b>	<b>29</b>
--------------	-----------

---

<b>SAMSUNG MAGIC Upscale</b>	<b>30</b>
------------------------------	-----------

---

<b>HDMI Black Level</b>	<b>30</b>
-------------------------	-----------

---

<b>Eye Saver Mode</b>	<b>30</b>
-----------------------	-----------

---

<b>Game Mode</b>	<b>30</b>
------------------	-----------

---

<b>Response Time</b>	<b>30</b>
----------------------	-----------

---

<b>Picture Size</b>	<b>31</b>
---------------------	-----------

---

<b>Screen Adjustment</b>	<b>31</b>
--------------------------	-----------

---

<b>Calibration Report</b>	<b>31</b>
---------------------------	-----------

---

# Table of contents

## PIP/PBP

PIP/PBP Mode	32
Size	33
Position	33
Sound Source	33
Source	34
Picture Size	34
Contrast	35

## OnScreen Display

Transparency	36
Position	36
Language	36
Display Time	36

## System

DisplayPort Ver.	37
HDMI Mode	37
FreeSync	38
Eco Saving Plus	39
Off Timer	39
PC/AV Mode	40
Source Detection	40
USB Hub	40
Key Repeat Time	40
Power LED On	40
Reset All	40
Information	40

## Installing the Software

Easy Setting Box	41
Restrictions and Problems with the Installation	41
System Requirements	41

## Troubleshooting Guide

Requirements Before Contacting Samsung Customer Service Center	42
Testing the Product	42
Checking the Resolution and Frequency	42
Check the following.	42
Q & A	44

## Specifications

General	45
Standard Signal Mode Table	46

## Appendix

Responsibility for the Pay Service (Cost to Customers)	48
Not a product defect	48
A Product damage caused by customer's fault	48
Others	48

# Chapter 01

## Before Using the Product

### Securing the Installation Space

Ensure some space around the product for ventilation. An internal temperature rise may cause fire and damage the product. Be sure to allow the amount of space as shown below or greater when installing the product.

— The exterior may differ depending on the product.

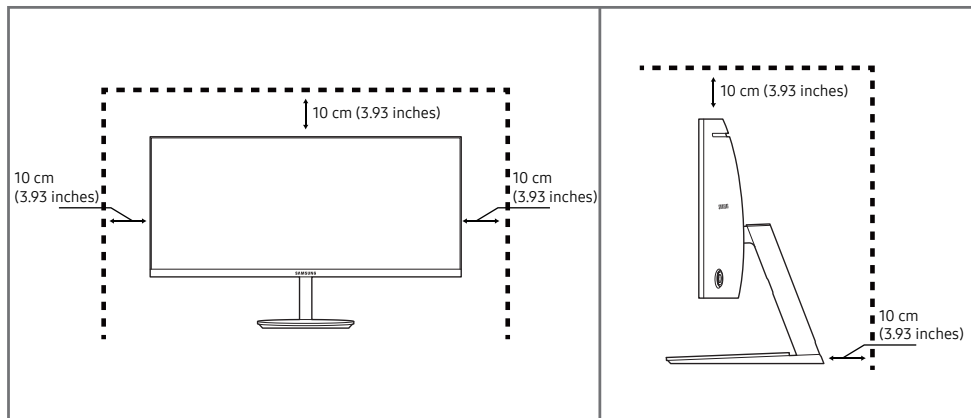

### Precautions for storage

High-glossy models can develop white stains on the surface if an ultrasonic wave humidifier is used nearby.

— Contact your nearest Samsung Customer Service Center if you want to clean the inside of the product (Service fee will be charged.)

### Safety Precautions

#### Warning

A serious or fatal injury may result if instructions are not followed.

#### Caution

Personal injury or damage to properties may result if instructions are not followed.

---

## Cleaning

— Take the following steps when cleaning.

- 1 Power off the product and computer.
- 2 Disconnect the power cord from the product.
  - Hold the power cable by the plug and do not touch the cable with wet hands. Otherwise, an electric shock may result.
- 3 Wipe the monitor with a clean, soft and dry cloth.
  - Do not apply a cleaning agent that contains alcohol, solvent, or surfactant to the monitor.
  - Do not spray water or detergent directly on the product.
- 4 Wet a soft and dry cloth in water and wring thoroughly to clean the exterior of the product.
- 5 Connect the power cord to the product when cleaning is finished.
- 6 Power on the product and computer.

---

## Electricity and Safety

### Warning

- Do not use a damaged power cord or plug, or a loose power socket.
- Do not use multiple products with a single power socket.
- Do not touch the power plug with wet hands.
- Insert the power plug all the way in so it is not loose.
- Connect the power plug to a grounded power socket (type 1 insulated devices only).
- Do not bend or pull the power cord with force. Be careful not to leave the power cord under a heavy object.
- Do not place the power cord or product near heat sources.
- Clean any dust around the pins of the power plug or the power socket with a dry cloth.

### Caution

- Do not disconnect the power cord while the product is being used.
- Only use the power cord provided with your product by Samsung. Do not use the power cord with other products.
- Keep the power socket where the power cord is connected unobstructed.
  - The power cord must be disconnected to cut off power to the product when an issue occurs.
- Hold the plug when disconnecting the power cord from the power socket.

---

## Installation

### Warning

- DO NOT PLACE CANDLES, INSECT REPELLANTS OR CIGARETTES ON TOP OF THE PRODUCT. DO NOT INSTALL THE PRODUCT NEAR HEAT SOURCES.
- Do not install the product in poorly ventilated spaces such as a bookcase or closet.
- Install the product at least 10cm away from the wall to allow ventilation.
- Keep the plastic packaging out of the reach of children.
  - Children may suffocate.
- Do not install the product on an unstable or vibrating surface (insecure shelf, sloped surface, etc.)
  - The product may fall and become damaged and/or cause an injury.
  - Using the product in an area with excess vibration may damage the product or cause a fire.
- Do not install the product in a vehicle or a place exposed to dust, moisture (water drips, etc.), oil, or smoke.
- Do not expose the product to direct sunlight, heat, or a hot object such as a stove.
  - The product lifespan may be reduced or a fire may result.
- Do not install the product within the reach of young children.
  - The product may fall and injure children.
- Edible oil, such as soybean oil, can damage or deform the product. Do not install the product in a kitchen or near a kitchen counter.

### Caution

- Do not drop the product while moving.
- Do not set down the product on its front.
- When installing the product on a cabinet or shelf, make sure that the bottom edge of the front of the product is not protruding.
  - The product may fall and become damaged and/or cause an injury.
  - Install the product only on cabinets or shelves of the right size.
- Set down the product gently.
  - Product failure or personal injury may result.
- Installing the product in an unusual place (a place exposed to a lot of fine dust, chemical substances, extreme temperatures or a significant presence of moisture, or a place where the product will operate continuously for an extended period of time) may seriously affect its performance.
  - Be sure to consult Samsung Customer Service Center if you want to install the product at such a place.

---

## Operation

### Warning

- There is a high voltage inside the product. Never disassemble, repair or modify the product yourself.
  - Contact Samsung Customer Service Center for repairs.
- To move the product, first disconnect all the cables from it, including the power cable.
- If the product generates abnormal sounds, a burning smell or smoke, disconnect the power cord immediately and contact Samsung Customer Service Center.
- Do not let children hang from the product or climb on top of it.
  - Children may become injured or seriously harmed.
- If the product is dropped or the outer case is damaged, turn off the power and disconnect the power cord. Then contact Samsung Customer Service Center.
  - Continued use can result in a fire or electric shock.
- Do not leave heavy objects or items that children like (toys, sweets, etc.) on top of the product.
  - The product or heavy objects may fall as children try to reach for the toys or sweets resulting in a serious injury.
- During a lightning or thunderstorm, power off the product and remove the power cable.
- Do not drop objects on the product or apply impact.
- Do not move the product by pulling the power cord or any cable.
- If a gas leakage is found, do not touch the product or power plug. Also, ventilate the area immediately.
- Do not lift or move the product by pulling the power cord or any cable.
- Do not use or keep combustible spray or an inflammable substance near the product.
- Ensure the vents are not blocked by tablecloths or curtains.
  - An increased internal temperature may cause a fire.
- Do not insert metallic objects (chopsticks, coins, hairpins, etc) or objects that burn easily (paper, matches, etc) into the product (via the vent or input/output ports, etc).
  - Be sure to power off the product and disconnect the power cord when water or other foreign substances have entered the product. Then contact Samsung Customer Service Center.
- Do not place objects containing liquid (vases, pots, bottles, etc) or metallic objects on top of the product.
  - Be sure to power off the product and disconnect the power cord when water or other foreign substances have entered the product. Then contact Samsung Customer Service Center.

---

## Caution

- Leaving the screen fixed on a stationary image for an extended period of time may cause afterimage burn-in or defective pixels.
    - Activate power-saving mode or a moving-picture screen saver if you will not be using the product for an extended period of time.
  - Disconnect the power cord from the power socket if you do not plan on using the product for an extended period of time (vacation, etc).
    - Dust accumulation combined with heat can cause a fire, electric shock or electric leakage.
  - Use the product at the recommended resolution and frequency.
    - Your eyesight may deteriorate.
  - Do not put AC/DC adapters together.
  - Remove the plastic bag from the AC/DC adapter before you use it.
  - Do not let water enter the AC/DC adapter device or get the device wet.
    - An electric shock or fire may result.
    - Avoid using the product outdoors where it can be exposed to rain or snow.
    - Be careful not to get the AC/DC adapter wet when you wash the floor.
  - Do not put the AC/DC adapter near to any heating apparatus.
    - Otherwise, a fire may result.
  - Keep the AC/DC adapter in a well-ventilated area.
  - If you place the AC/DC power adapter so that it is hanging with the cord input facing upwards, water or other foreign substances could enter the Adapter and cause the Adapter to malfunction. Make sure to rest the AC/DC power adapter flat on a table or the floor.
  - Do not hold the product upside-down or move it by holding the stand.
    - The product may fall and become damaged or cause an injury.
  - Looking at the screen too close for an extended period of time can deteriorate your eyesight.
  - Do not use humidifiers or stoves around the product.
  - Rest your eyes for more than 5 minutes or look at distance objects for every 1 hour of product use.
- Do not touch the screen when the product has been turned on for an extended period of time as it will become hot.
  - Store small accessories out of the reach of children.
  - Exercise caution when adjusting the product angle or stand height.
    - Your hand or finger may get stuck and injured.
    - Tilting the product at an excessive angle may cause the product to fall and an injury may result.
  - Do not place heavy objects on the product.
    - Product failure or personal injury may result.
  - When using headphones or earphones, do not turn the volume too high.
    - Having the sound too loud may damage your hearing.



# Chapter 02

## Preparations

### Parts

#### Control Panel

The color and shape of parts may differ from what is shown. Specifications are subject to change without notice to improve quality.

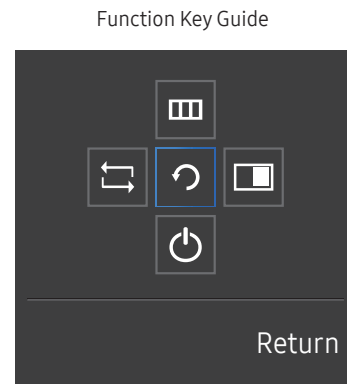
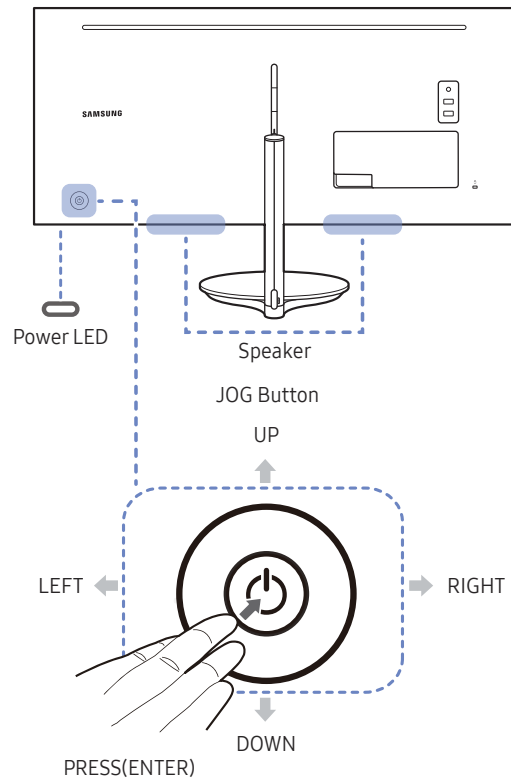

Parts	Description
JOG Button	Multi directional button that helps navigate. The JOG button is located on the rear left side of the product. The button can be used to move up, down, left or right, or as Enter.
Power LED	This LED is power status indicator and works as <ul style="list-style-type: none"> <li>Power On (Power button): Off</li> <li>Power saving mode: Blinking</li> <li>Power Off (Power button): On</li> </ul> The power Indicator operation can be swapped by changing in the menu. (System → Power LED On) Actual models because of functional variation maybe haven't this function.
Function Key Guide	Press the JOG button when the screen is turned on. The Function Key Guide will appear. To access the onscreen menu when the guide is displayed, press the corresponding direction button again. Function Key Guide may vary depending on the function or product model. Please refer to the actual product.

---

## Direct Key guide



— The shortcut button screen (OSD menu) shown below is displayed only when the monitor screen is turned on, the computer resolution changes, or the input source changes.

— The function buttons page shows if **Eye Saver Mode** is enabled.

 : On

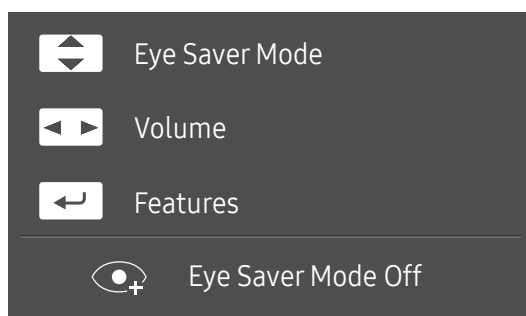
 : Off



-  : Adjust **Brightness**, **Contrast**, **Eye Saver Mode**.
-  : Adjust **Volume**.
-  : Display Function Key Guide.





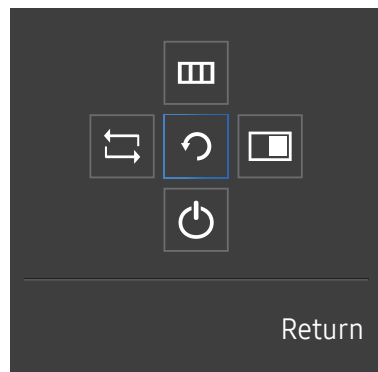



## Function Key Guide

— To enter the main menu or to use other items, press the JOG button to display the Function Key Guide. You can exit by pressing the JOG button again.



UP/DOWN/LEFT/RIGHT: Move to the item you want. The description for each item will appear when the focus changes.

PRESS(ENTER): The selected item will be applied.

Icons	Description
	Selects  to change the input signal by moving the JOG button in the Function Key Guide screen. A message will appear on the top left corner of the screen if the input signal has been changed.
	Selects  by moving the JOG button in the function key guide screen. The OSD (On Screen Display) of your Monitor's feature appears. OSD control lock: Maintain the current settings, or lock the OSD control to prevent unintended changes to settings. Enable/Disable: To lock/unlock the OSD control, press the LEFT button for 10 seconds when the main menu displayed. — If the OSD control is locked, <b>Brightness</b> and <b>Contrast</b> can be adjusted. <b>PIP/PBP</b> is available. <b>Eye Saver Mode</b> is available. <b>Information</b> can be viewed.
	Selects  by moving the JOG button in the function key guide screen. Press the button when configuring settings for the <b>PIP/PBP</b> function is required.
	Selects  to turn the Monitor off by moving the JOG button in the function key guide screen.

— Actual models because of functional variation, Function key guide options will be different.

---

When the monitor displays nothing (i.e. Power saving mode or Non-signal mode), 2 direct keys for control source and power could be used as below.

JOG Button	Power saving/Non-signal mode
UP	Source Change
Down	
PRESS(ENTER) for 2 seconds	Power Off

When the monitor displays the Main menu the JOG Button could be used as below.

JOG Button	Action
UP/DOWN	Move the option
	Exit the Main menu.
LEFT	Close Sublist without saving value. Value decreases in the slider.
RIGHT	Move to next depth. Value increases in the slider.
PRESS(ENTER)	Move to next depth. Save the value and close Sublist.

---

## Changing Brightness, Contrast and Eye Saver Mode settings

You can adjust **Brightness**, **Contrast** or **Eye Saver Mode** by moving the JOG button up or down, if no OSD menu is displayed.



- The displayed image may differ depending on the model.
- The default brightness can vary depending on the region.

### Eye Saver Mode

### Brightness

- This menu is not available when **SAMSUNG MAGICBright** is set to **Dynamic Contrast** mode.
- This menu is not available when **Eco Saving Plus** is enabled.
- This menu is not available when **Eye Saver Mode** is enabled.

### Contrast

- This menu is not available when **SAMSUNG MAGICBright** is in **Cinema** or **Dynamic Contrast** mode.
- This menu is not available when **Game Mode** is enabled.
- This menu is not available when **PIP/PBP Mode** is set to **On** and the **Size** is set to  (PBP Mode).

---

## Changing the Volume setting

You can adjust **Volume** by moving the JOG button left or right, if no OSD menu is displayed.







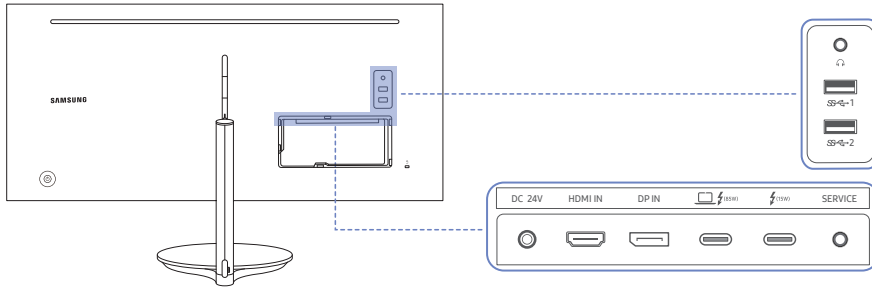

- The displayed image may differ depending on the model.
- If the audio quality of a connected input device is poor, the Auto Mute function on the product may mute the sound or cause choppy audio when applying the headphones or speakers. Set the input volume for the input device to at least 20% and control the volume using the volume control (JOG button LEFT/RIGHT) on the product.
  - What is Auto Mute?  
The function mutes the audio to improve sound effect when there is sound noise or when the input signal is weak, usually due to a problem with the volume of an input device.
- To activate the **Mute** function, access the **Volume** control screen, then use the JOG button to move the focus down.
- To disable the **Mute** function, increase or decrease the **Volume**.

## Types of Ports

The functions available may vary depending on the product model. The color and shape of parts may differ from what is shown. Specifications are subject to change without notice to improve quality. Refer to the actual product.



Port	Description
DC 24V 	Connects to the AC/DC adapter.
HDMI IN 	Connects to a source device using an HDMI cable or HDMI-DVI cable.
DP IN 	Connects to a PC using a DP cable.
	Connects to a PC using a Thunderbolt™ 3 cable.
SERVICE 	Dedicated to service technicians. This port is for servicing only and has no user function. Do not connect a cable to this port.
	Connect to an audio output device such as headphones.
	These ports are enabled when a PC is connected to the Thunderbolt™ 3 port using a Thunderbolt™ 3 cable or USB Type-C cable.

## Upgrading the Software via USB

- 1 Be sure to insert the USB disk into the USB port marked out with the blue box as shown in the figure below. You can upgrade the software via USB only if either the monitor screen operates normally or the check signal is displayed on the monitor screen.



When the screen as shown in the following figure is displayed, press and hold the Down arrow key for 5 seconds.

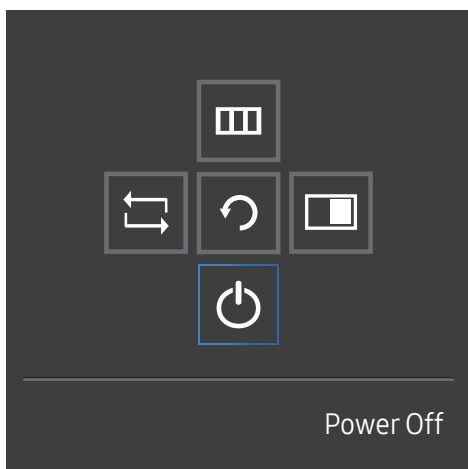

- 2 When the message as shown in the following figure is displayed on the monitor, select **Yes** to upgrade the software.

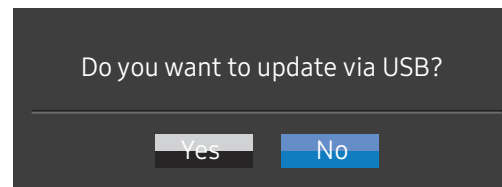

- 3 When the screen as shown in the following figure is displayed, select **Yes**.

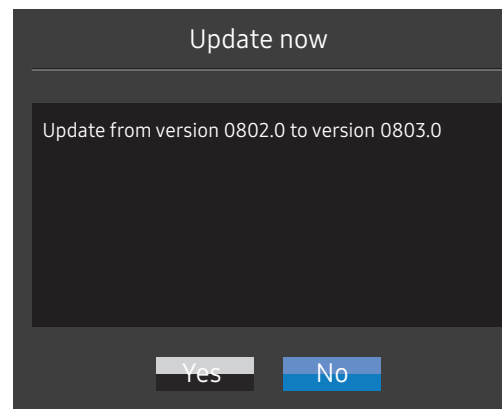

- 4 The software upgrading proceeds.

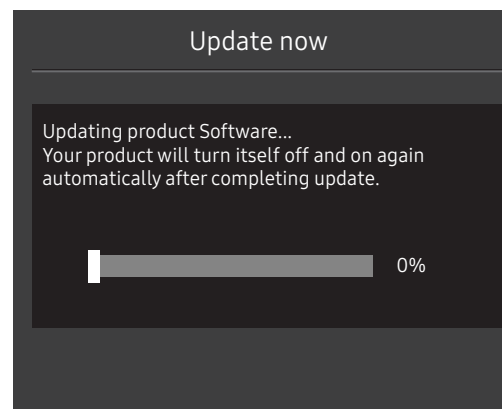

## Note

- 1 Before upgrading through USB disk, you need to format the USB disk into the FAT32 format.
- 2 Make sure upgrade file extension is .BIN and only the BIN file is in the USB disk.
- 3 Please confirm the upgrade file name matches the software version name in OSD - information.  
For example, m-J\*\*\*\*\*\_\*\*\*\*.\*[4-digit number].bin, the first half "m-J\*\*\*\*\*-" must match, and the last half \*\*\*\*.\*[4-digit number] which means the version number and checksum could be different. And the upgrade file must be copied to the root directory.
- 4 If you want to keep the current version or degrade to a lower version, you may change file name to m-J\*\*\*\*\*-0000.0[4-digit number] and then perform the same operations.
- 5 If the **No valid update files found. Please check your USB device and try again.** message is displayed, this is probably due to the following reasons.

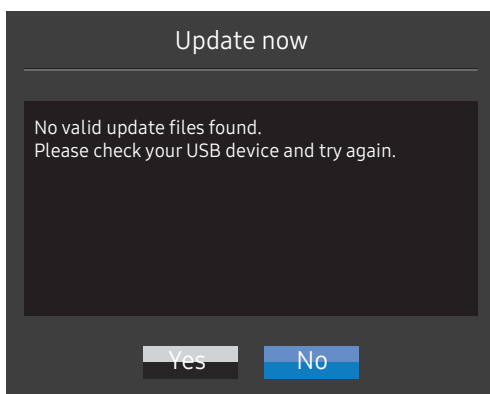

- No USB disk is inserted into the USB port marked out with the blue box.
  - The USB disk format is not supported.
  - The USB disk contains no valid upgrade files. (No upgrade files exist, or the file names are incorrect.)
- 6 Do not turn off the monitor. And prevent the upgrading from any interruption as far as possible. If an interruption happens, the monitor will return to the production version.
- Note that the production version may not be the same as the version before this upgrading if some other upgrading has been done earlier.
- Before upgrading, you need to make sure **USB Hub** set to **On**.

## Adjusting the Product Tilt and Height

— The color and shape of parts may differ from what is shown. Specifications are subject to change without notice to improve quality.

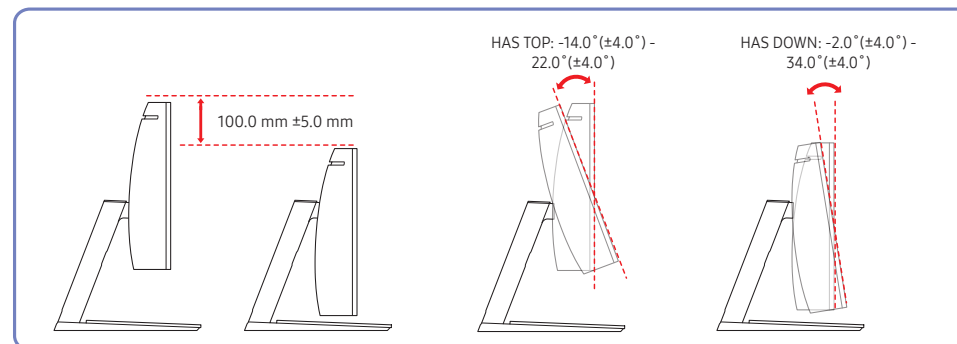

- The monitor tilt and height can be adjusted.
- To avoid damage to the product when adjusting the tilt, push or pull the top area of the product at the center while holding the top of the stand.



## Anti-theft Lock

- An anti-theft lock allows you to use the product securely even in public places.
- The locking device shape and locking method depend on the manufacturer. Refer to the user guide provided with your anti-theft locking device for details.

### To lock an anti-theft locking device:

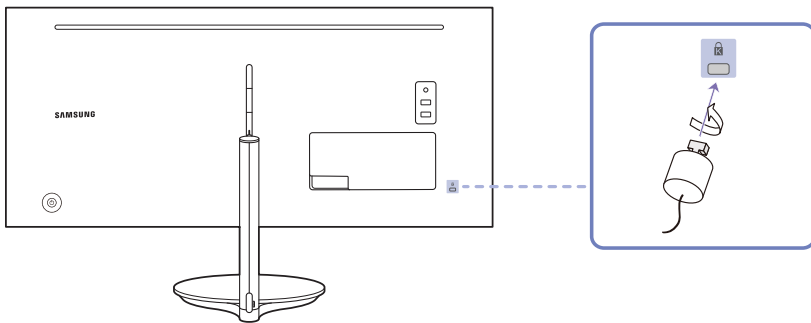

- 1 Fix the cable of your anti-theft locking device to a heavy object such as a desk.
- 2 Put one end of the cable through the loop on the other end.
- 3 Insert the locking device into the anti-theft lock slot at the back of the product.
- 4 Lock the locking device.
  - An anti-theft locking device can be purchased separately.
  - Refer to the user guide provided with your anti-theft locking device for details.
  - Anti-theft locking devices can be purchased at electronics retailers or online.

## Precautions for moving the monitor

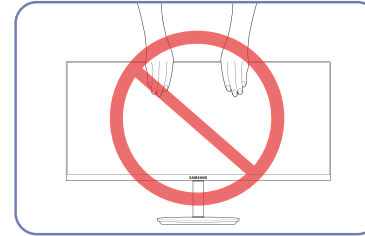

- Do not hold the screen when moving or adjusting the height of the monitor. This may damage the monitor.

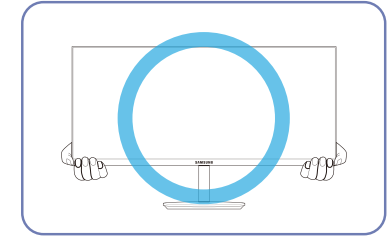

- Hold the lower corners or edges of the monitor when moving it.

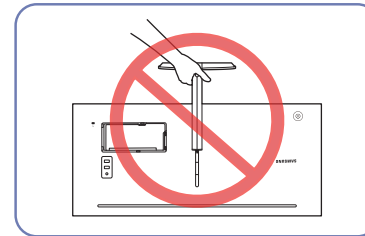

- Do not hold the product upside down only by the stand.

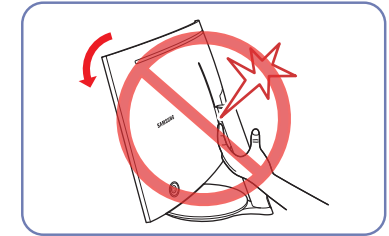

- Do not put the hand below the stand body.

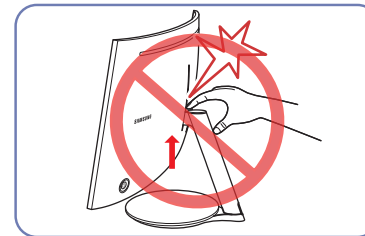

- Take extra care to ensure your hand does not get stuck in the height adjustment area. This could injure your hand.

# Installation

## Removing the Stand

— Before removing the stand from the monitor, place the monitor on a flat and stable surface with the screen facing down.

**⚠** : The product is curved. Placing pressure on the product when on a flat surface may damage the product. When the product is on the ground facing up or down, do not put pressure on it.

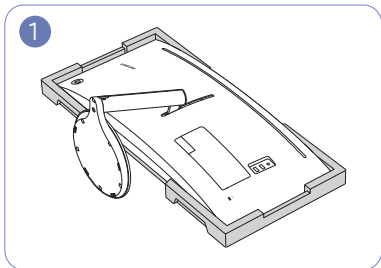

Place the protective Styrofoam (cushion) included in the package on the floor and place the product facing down on the Styrofoam, as shown in the image.

— Make sure to use the styrofoam (cushion) that came with the monitor.

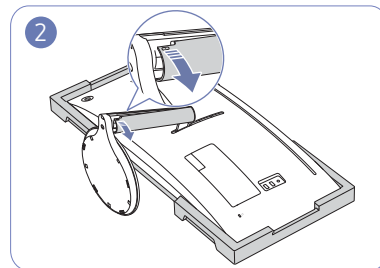

Grab the stand with one hand and use the thumb on your other hand to remove the COVER-STAND NECK LEFT in the direction of the arrow.

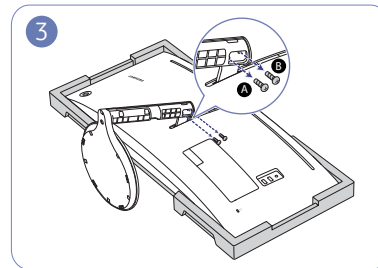

Unfasten screws for **A** and **B**.

— The screws are also used to attach the Wall-mount bracket. Be careful to ensure the screws are not missing.

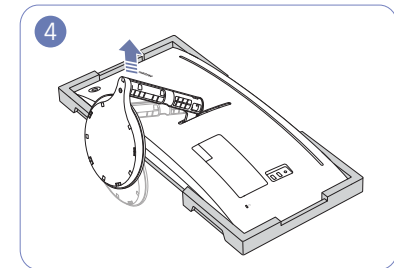

Lift and remove the stand.

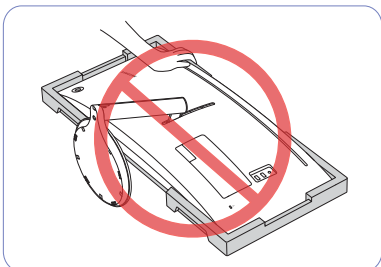

### Caution

Do not press down on the monitor. There is a risk of damaging the monitor.

## Attaching the Wall-mount bracket

— Power the product off and remove the power cable from the power socket.

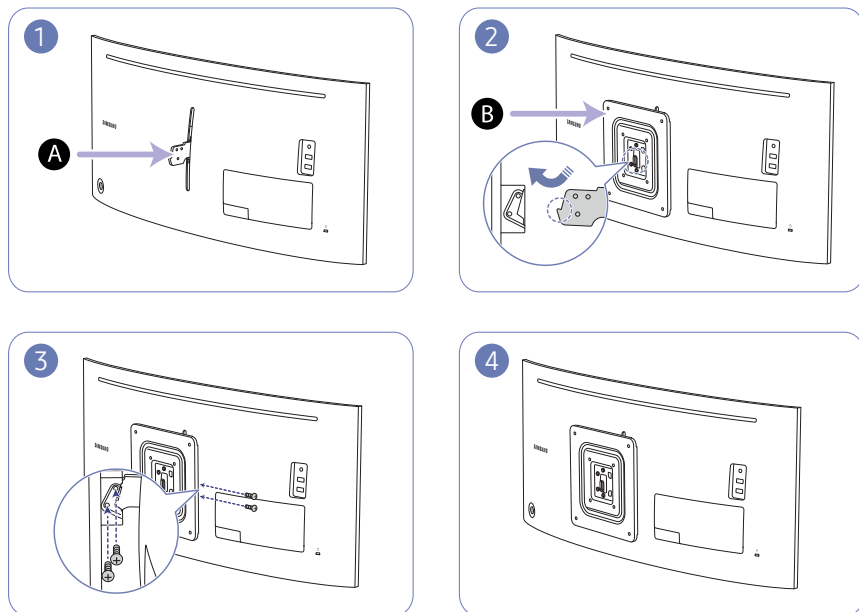

**A** Attach the Wall-mount bracket here

**B** Wall-mount bracket

Align **B** with **A** on the monitor, then tightly fasten with the screws removed from the stand (P.18).

### • Notes

- Using a screw longer than the standard length can damage the internal components of the product.
- The length of screws required for a wall mount that does not comply with the VESA standards may vary depending on the specifications.
- Do not use screws that do not comply with the VESA standards. Do not attach the wall-mount kit or desktop stand using excessive force. The product may get damaged or fall and cause personal injury. Samsung shall not be held liable for any damage or injury caused by using improper screws or attaching the wall-mount kit or desktop stand using excessive force.
- Samsung shall not be held liable for any product damage or personal injury caused by using a wall-mount kit other than the one specified or from an attempt to install the wall-mount kit on your own.
- To mount the product on a wall, ensure you purchase a wall-mount kit that can be installed 10 cm or farther away from the wall.
- Be sure to use a wall-mount kit that complies with the standards.
- To install the monitor using a wall mount, disconnect the stand base from the monitor.

Unit: mm (inches)

Model name	VESA screw hole specs in millimeters	Standard Screw	Quantity
C34J791WT*	100.0 x 100.0 (3.9 x 3.9)	M4	4 EA

— Do not attach the Wall-mount bracket when the monitor is turned on. This may cause electric shock and might result in injury.

## Attaching the Stand

— Before assembling the product, place the product down on a flat and stable surface so that the screen is facing downwards.

**⚠** : The product is curved. Placing pressure on the product when on a flat surface may damage the product. When the product is on the ground facing up or down, do not put pressure on it.

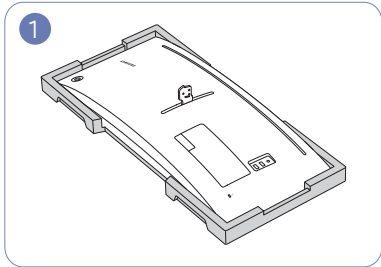

Place the protective Styrofoam (cushion) included in the package on the floor and place the product facing down on the Styrofoam, as shown in the image.

— Make sure to use the styrofoam (cushion) that came with the monitor.

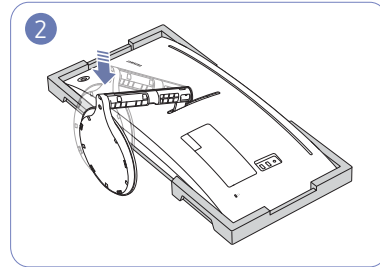

Attach the stand to the back of the monitor, in the direction of the arrow.

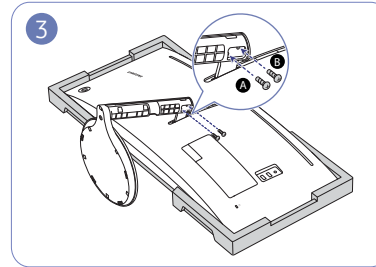

Rotate **A** and **B** screws for fixing.

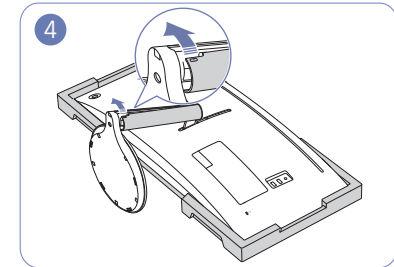

Grab the stand with one hand and use your other hand to attach the COVER-STAND NECK LEFT in the direction of the arrow.

Make sure that the arrow imprinted inside and the ▲ outside of the COVER STAND NECK LEFT are placed on the lower part. The COVER STAND NECK LEFT cannot be attached if the imprints are upside down.

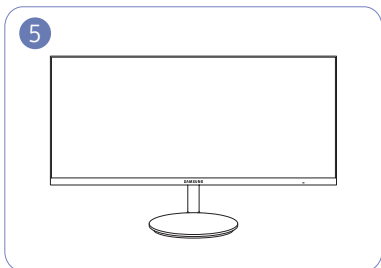

After attaching the stand, place the product in an upright position.

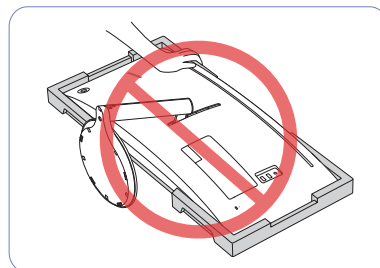

### Caution

Do not press down on the monitor. There is a risk of damaging the monitor.

## Chapter 03

# Connecting and Using a Source Device

### Read below before installing the monitor.

- 1 Check the shapes of both ends of the cables that came with the monitor, and check the shapes and positions of the matching ports on the monitor and external devices.
- 2 Before connecting signal cables, disconnect the power cables for the monitor and external devices from the power outlet to prevent device damage from a short circuit or overcurrent.
- 3 After connecting all signal cables, connect the power cables for the monitor and external devices to the power outlet.
- 4 Read the user manual to familiarize yourself with the monitor functions, precautions, and proper use, before using the installed monitor.

### Connecting and Using a PC

Select a connection method suitable for your PC.

- Connecting parts may differ in different products.
- Provided ports may vary depending on the product.

### Connection Using the HDMI Cable



Check to make sure that the power cables for the monitor and external devices, such as computers and set-top boxes, are not connected to the power outlet.

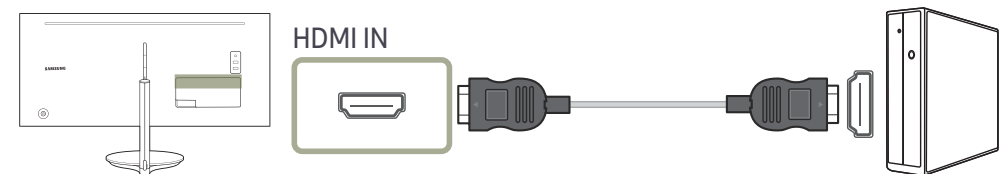

- For optimum resolution, use a graphics card and an HDMI cable that support HDMI2.0 output. Ensure your graphics card supports HDMI2.0 output using the graphics card manufacturer's website.
- Select an HDMI version. Version 2.0 supports a refresh rate of up to 100 Hz, and version 1.4 supports a refresh rate of up to 50 Hz.
- When using dual monitor mode with HDMI2.0 input, disabling dual monitor mode after turning on the monitor or entering power-saving mode may affect windows and other settings.

---

## Connection Using an HDMI-DVI Cable

- ⚠ Check to make sure that the power cables for the monitor and external devices, such as computers and set-top boxes, are not connected to the power outlet.

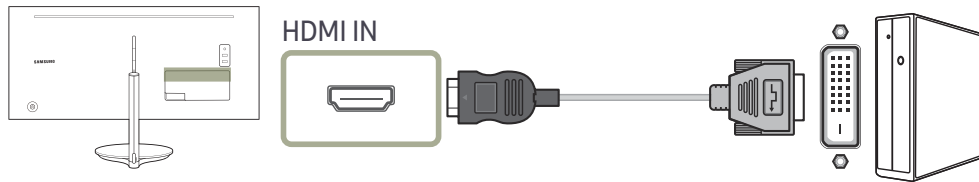

- The audio function is not supported if the source device is connected using the HDMI-DVI cable.
- The optimum resolution may not be available with an HDMI-DVI cable.

---

## Connection Using an DP Cable

- ⚠ Check to make sure that the power cables for the monitor and external devices, such as computers and set-top boxes, are not connected to the power outlet.

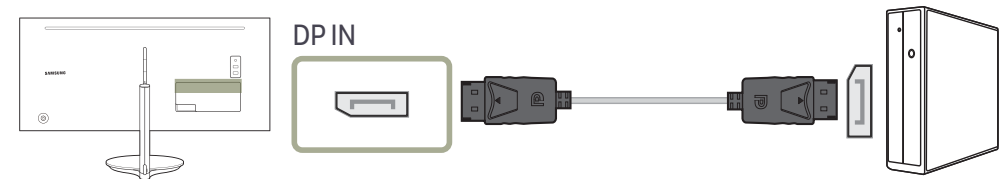

- To display 3440 x 1440 @ 100 Hz, use a DP cable that supports 3440 x 1440 @ 100 Hz. Make sure that the graphics card of the DP source supports 3440 x 1440 @ 100 Hz.

## Connection Using a Thunderbolt™ 3 Cable or USB Type-C Cable



Check to make sure that the power cables for the monitor and external devices, such as computers and set-top boxes, are not connected to the power outlet.

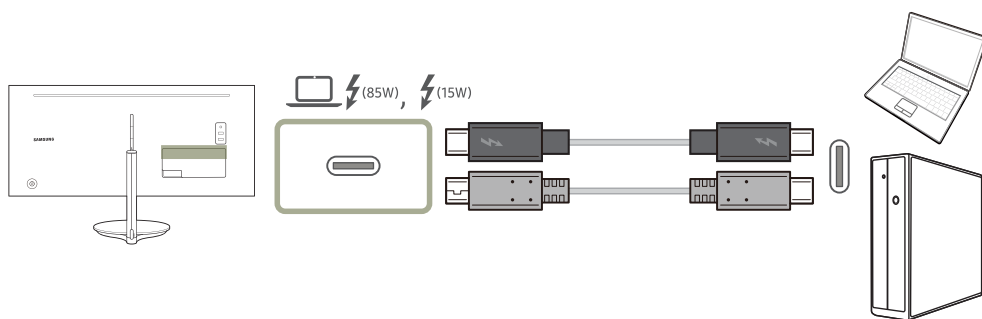

According to the USB Power Delivery 3.0 specification, our product can charge your notebook when you connect it to our product using a Thunderbolt™ 3 cable.

To get the full experience of the Thunderbolt™ 3 technology, connect a PC that supports this technology using a Thunderbolt™ 3 cable and ensure that all connected devices and cables are approved by Intel Thunderbolt. For detailed approval information, visit the official Intel website.



Before using the product, update the BIOS program, Thunderbolt firmware, and Thunderbolt software of your PC to their latest versions by visiting the official website of your PC.

Although there are two Thunderbolt™ 3 ports, only the first connected Thunderbolt™ 3 host can be identified as the host device. For detailed connecting specification of Thunderbolt™ 3 port, please visit the official website of Thunderbolt.

Dual display (daisy chain) support depends on your PC and the connected Thunderbolt™ 3 cable. The Thunderbolt™ 3 port on your PC must support dual 4 K @ 60 Hz output, and the particular Thunderbolt™ 3 cable need to be purchased separately. For detailed specification of the Thunderbolt™ 3 cable, visit the official Thunderbolt website.

If you want to charge your notebook, make sure that your notebook supports power input. Many Thunderbolt 3-compatible PCs do not support charging over a USB Type-C port, and some PCs can charge only their own branded power adapters. Because notebooks released in the market are very various, we cannot guarantee that our product can charge all types of notebooks over a Thunderbolt™ 3 port.

Unlike USB devices, Thunderbolt 3 devices must be manually authenticated through Intel's Thunderbolt program before the system recognizes them.

- Considering that it takes a relatively long time to complete the connection and disconnection over Thunderbolt, do not quickly plug in and unplug the signal cable or power cable. Otherwise, your devices may be damaged.
- For , a maximum charging power of 85 W is supported. For , a maximum charging power of 15 W is supported. Charging speed may vary depending on the notebook connected to our product.
- Make sure that the Thunderbolt™ 3 or USB Type-C cable complies with the Thunderbolt™ 3 or USB Type-C specification. Otherwise, your devices may be damaged. A Samsung branded cable is recommended.
- When the product is connected to a USB Type-C notebook, the product supports up to 60 Hz vertical frequency at the maximum resolution (3440 x 1440).
- Because of compatibility with the Thunderbolt™ technology, phones that support the USB Type-C display may not be displayed on our product. To fix this problem, you may need to upgrade the firmware from your phone's manufacturer.

## Connecting to Headphones

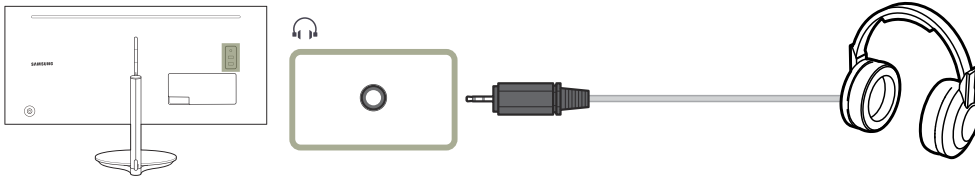

## Connecting the Power

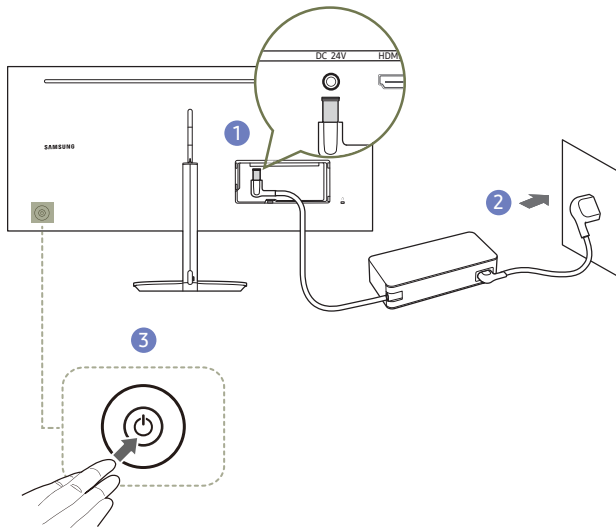

- 1 Connect the power cable to the AC/DC adapter. Then, connect the AC/DC adapter to the DC 24V port on the back of the product.
- 2 Next, connect the power cable to the power outlet.
- 3 Press the JOG button on the back of the monitor to turn it on.

— The input voltage is switched automatically.



## Connecting the Product to a PC as a USB HUB

### Connecting a PC to the Product

— The product can function as a USB hub when connected to a PC via a Thunderbolt™ 3 cable or USB Type-C cable. You can connect a source device directly to the product and control the device from the product, without having to connect the device to the PC.

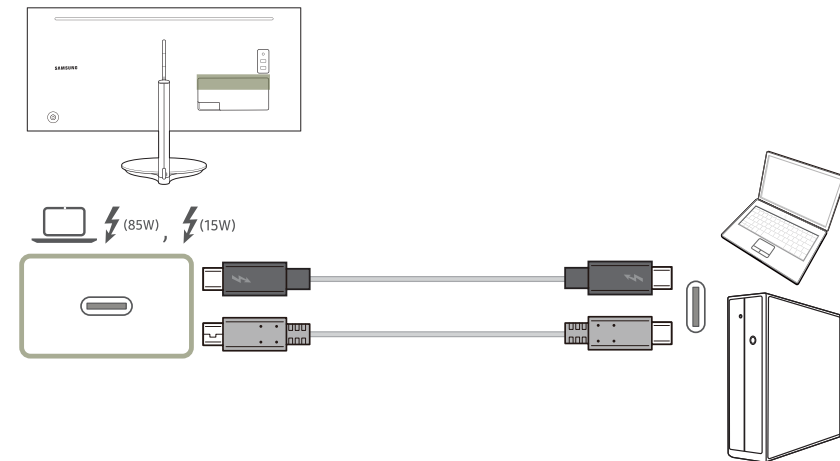
To use the product as a USB hub, connect the product to a PC using a Thunderbolt™ 3 cable or USB Type-C cable.



Connect the Thunderbolt™ 3 cable or USB Type-C cable to  on the back of the product and  on the PC.



## Utilizing the Product as a USB HUB

Using the product as a hub, connect and use various source devices with the product at the same time.

A PC cannot connect to multiple source devices at the same time as it has a limited number of input/output ports available. The HUB feature on the product will improve your work efficiency by allowing you to connect multiple source devices to the USB ports on the product at the same time without connecting them to a PC.

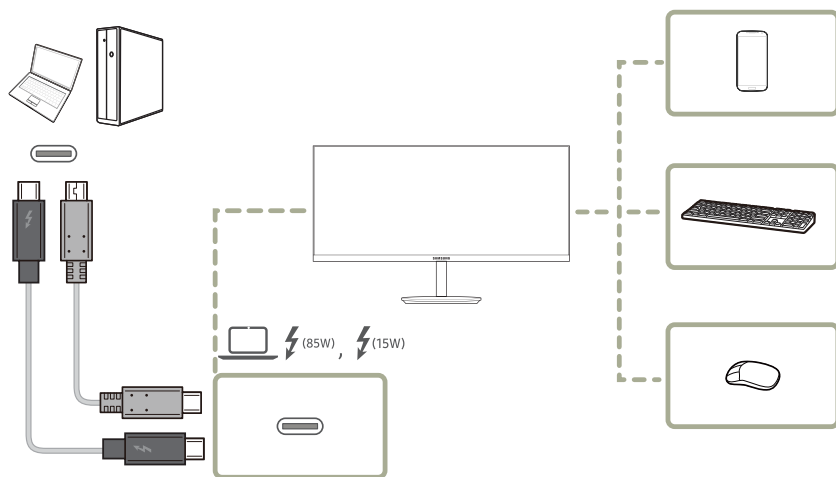

If multiple source devices are connected to the PC, the many cables around the PC may look messy. Connecting the devices directly to the product will resolve such inconvenience.

Connect a mobile device such as an MP3 player or smartphone to the product when connected to a PC. This allows you to control the device from the PC or charge the device battery.

— The function can't be available when **USB Hub** is set to **Off**. (**System** → **USB Hub**) Actual models because of functional variation maybe haven't this function.

- Performance can vary, depending on the USB version supported by the external device.
- An external mass-storage HDD requires an external power supply. Be sure to connect it to a power source. (Refer to the device user manual)
- If you connect the product to a notebook that has limited support for USB Type-C, the USB hub may not work properly.
- The product does not support media play. If you need to play a file on your USB device, connect the product as a USB hub to your source device, and then play the file on your source device.
- For USB-related problems caused by OS, drive programs or software, please contact relevant suppliers.
- With the launch of various USB devices on the market, we cannot guarantee that our products are matched with all USB devices.
- The battery can be charged in the power-saving mode, but it cannot be charged when the product is powered off.
- Charging your USB device is not possible if the power cable is disconnected from the power socket.
- The USB device needs to be purchased separately.

## Tidying Up the Connected Cables

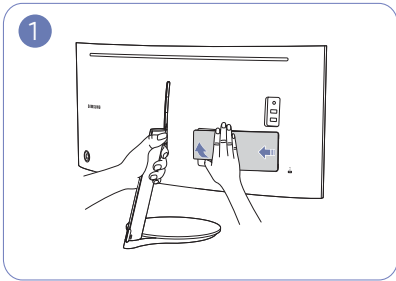

Grab the stand with one hand and use the thumb on your other hand to remove the COVER-REAR-SUB in the direction of the arrow.

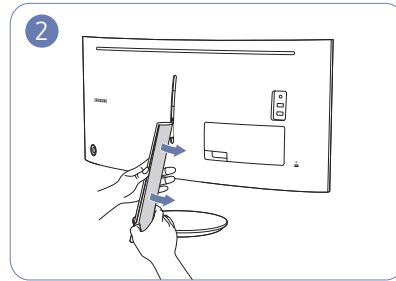

Grab the stand with one hand and use the thumb on your other hand to remove the COVER-STAND NECK LEFT in the direction of the arrow.

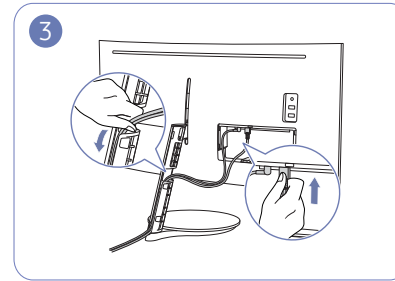

Connect cables to the appropriate ports.  
Run the cables through the opening on the stand, as shown in the image.

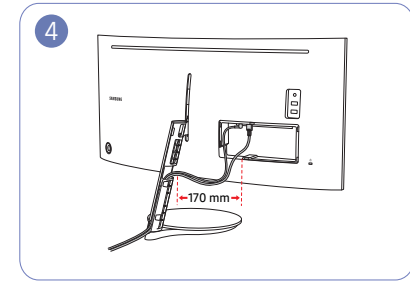

Ensure that the length of the cables, within the range indicated in the image, is at least 170 mm, so that the cables are loose.

Tight cables make it difficult to attach the COVER-STAND NECK LEFT.

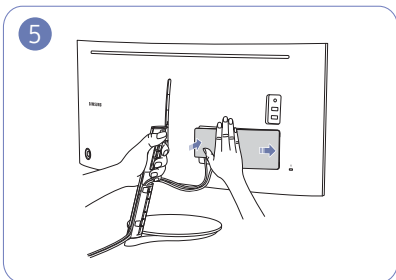

Grab the stand with one hand and use your other hand to close the COVER-REAR-SUB in the direction of the arrow.

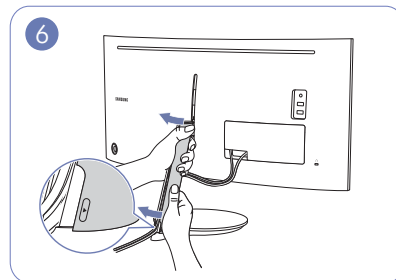

Grab the stand with one hand and use your other hand to attach the COVER-STAND NECK LEFT in the direction of the arrow.

Make sure that the arrow imprinted inside and the ▲ outside of the COVER STAND NECK LEFT are placed on the lower part. The COVER STAND NECK LEFT cannot be attached if the imprints are upside down.

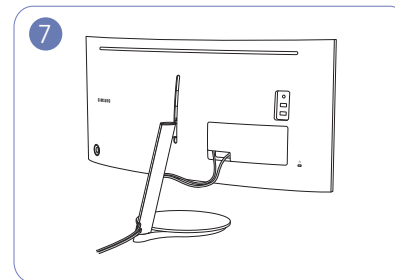

The cables are now tidied up.

---

## Correct posture to use the product



Use the product in the correct posture as follows:

- Straighten your back.
- Allow a distance of 45 to 50cm between your eye and the screen, and look slightly downward at the screen.
- Keep your eyes directly in front of the screen.
- Adjust the angle so light does not reflect on the screen.
- Keep your forearms perpendicular to your upper arms and level with the back of your hands.
- Keep your elbows at about a right angle.
- Adjust the height of the product so you can keep your knees bent at 90 degrees or more, your heels attached to the floor, and your arms lower than your heart.
- Do the Eye exercises or blink frequently, then eye fatigue will be relieved.

---

## Driver Installation

- You can set the optimum resolution and frequency for this product by installing the corresponding drivers.
- To install the latest version of the product driver, download it from the Samsung Electronics website at <http://www.samsung.com>.

## Setting Optimum Resolution

An information message about setting optimum resolution will appear if you power on the product for the first time after purchase.

Select a language on the product and change the resolution on your PC to the optimum setting.

- If the optimum resolution is not selected, the message will appear up to three times for a specified time even when the product is turned off and on again.
- The optimum resolution can also be selected in Control Panel on your PC.

# Chapter 04

## Picture

A detailed description of each function is provided. Refer to your product for details.

— The functions available may vary depending on the product model. The color and shape of parts may differ from what is shown. Specifications are subject to change without notice to improve quality.

### SAMSUNG MAGIC Bright

This menu provides an optimum picture quality suitable for the environment where the product will be used.

- This menu is not available when **Eco Saving Plus** is enabled.
- This menu is not available when **Game Mode** is enabled.
- This menu is not available when **Eye Saver Mode** is enabled.
- Not available when **PIP/PBP Mode** is set to **On**.

You can customize the brightness to suit your preferences.

#### In PC mode

- **Custom**: Customize the contrast and brightness as required.
- **Standard**: Obtain a picture quality suitable for editing documents or using Internet.
- **Cinema**: Obtain the brightness and sharpness of TVs suitable for enjoying video and DVD content.
- **Dynamic Contrast**: Obtain balanced brightness through automatic contrast adjustment.
- **High Bright**: Maximize the screen brightness.

#### In AV mode

When the external input is connected through HDMI/DP and **PC/AV Mode** is set to **AV**, **SAMSUNG MAGIC Bright** has four automatic picture settings (**Dynamic**, **Standard**, **Movie** and **Custom**) that are preset at the factory. You can activate either **Dynamic**, **Standard**, **Movie** or **Custom**. You can select **Custom** which automatically recalls your personalized picture settings.

- **Dynamic**: Select this mode to view a sharper image than in **Standard** mode.
- **Standard**: Select this mode when the surroundings are bright. This also provides a sharp image.
- **Movie**: Select this mode when the surroundings are dark. This will save power and reduce eye fatigue.
- **Custom**: Select this mode when you want to adjust the image according to your preferences.

---

## Brightness

You can adjust the general brightness of the picture. (Range: 0~100)

A higher value will make the picture appear brighter.

- This menu is not available when **SAMSUNG MAGICBright** is set to **Dynamic Contrast** mode.
- This menu is not available when **Eco Saving Plus** is enabled.
- This menu is not available when **Eye Saver Mode** is enabled.

## Contrast

Adjust the contrast between the objects and background. (Range: 0~100)

A higher value will increase the contrast to make the object appear clearer.

- This option is not available when **SAMSUNG MAGICBright** is in **Cinema** or **Dynamic Contrast** mode.
- This menu is not available when **Game Mode** is enabled.
- This menu is not available when **PIP/PBP Mode** is set to **On** and the **Size** is set to  (PBP Mode).

## Sharpness

Make the outline of objects more clear or blurry. (Range: 0~100)

A higher value will make the outline of objects clearer.

- This option is not available when **SAMSUNG MAGICBright** is in **Cinema** or **Dynamic Contrast** mode.
- This menu is not available when **SAMSUNG MAGICUpscale** is in **Mode1** or **Mode2** mode.
- This menu is not available when **Game Mode** is enabled.
- Not available when **PIP/PBP Mode** is set to **On**.

---

## Color

Adjust the tint of the screen.

- This menu is not available when **SAMSUNG MAGICBright** is set to **Cinema** or **Dynamic Contrast** mode.
- This menu is not available when **Game Mode** is enabled.
- This menu is not available when **Eye Saver Mode** is enabled.
- Not available when **PIP/PBP Mode** is set to **On**.
- **Red**: Adjust the red saturation level. Values closer to 100 mean greater intensity for the color.
- **Green**: Adjust the green saturation level. Values closer to 100 mean greater intensity for the color.
- **Blue**: Adjust the blue saturation level. Values closer to 100 mean greater intensity for the color.
- **Color Tone**: Select a color tone that best suits your viewing needs.
  - **Cool 2**: Set the color temperature to be cooler than **Cool 1**.
  - **Cool 1**: Set the color temperature to be cooler than **Normal** mode.
  - **Normal**: Display the standard color tone.
  - **Warm 1**: Set the color temperature to be warmer than **Normal** mode.
  - **Warm 2**: Set the color temperature to be warmer than **Warm 1**.
  - **Custom**: Customize the color tone.
- When the external input is connected through HDMI/DP and **PC/AV Mode** is set to **AV**, **Color Tone** has four color temperature settings (**Cool**, **Normal**, **Warm** and **Custom**).
- **Gamma**: Adjust the middle level of luminance.
  - **Mode1** / **Mode2** / **Mode3**

---

## SAMSUNG MAGIC Upscale

**SAMSUNG MAGIC Upscale** function can enhance the layers of the picture details and the vividness of the picture.

The function has more obvious effects on low-resolution pictures.

- This menu is not available when **SAMSUNG MAGIC Bright** is set to **Cinema** or **Dynamic Contrast** mode.
- This menu is not available when **Game Mode** is enabled.
- Not available when **PIP/PBP Mode** is set to **On**.
- **Off / Mode1 / Mode2**
  - Comparing with **Mode1**, **Mode2** has a stronger effect.

## HDMI Black Level

If a DVD player or set-top box is connected to the product via HDMI, image quality degradation (contrast/color degradation, black level, etc.) may occur, depending on the connected source device. In such case, **HDMI Black Level** can be used to adjust the image quality.

If this is the case, correct the degraded picture quality using **HDMI Black Level**.

- This function is only available in **HDMI** mode.
- Not available when **PIP/PBP Mode** is set to **On**.
- **Normal**: Select this mode when there is no contrast ratio degradation.
- **Low**: Select this mode to reduce the black level and increase the white level when there is a contrast ratio degradation.
- **HDMI Black Level** may not be compatible with some source devices.
- The **HDMI Black Level** feature is only activated at a certain **AV** resolution, such as 720P and 1080P.

---

## Eye Saver Mode

Set to an optimum picture quality suitable for eye relaxation.

TÜV Rheinland “Low Blue Light Content” is a certification for products which meet requirements for lower blue light levels. When **Eye Saver Mode** is ‘**On**’, the blue light that wavelength is around 400nm will decrease, and it will provide an optimum picture quality suitable for eye relaxation. At the same time, the blue light level is lower than in the default settings, and it was tested by TÜV Rheinland and certified as it met the requirements of TÜV Rheinland “Low Blue Light Content” standards.

## Game Mode



Configure the product screen settings for game mode.

Use this feature when playing games on a PC or when a game console such as PlayStation™ or Xbox™ is connected.

- This menu is not available when **Eye Saver Mode** is enabled.
- When the monitor turns off, enters power-saving mode or changes input sources, **Game Mode** turns **Off** even if it is set to **On**.
- If you want to keep **Game Mode** enabled all the time, select **Always On**.
- Not available when **PIP/PBP Mode** is set to **On**.

## Response Time

Accelerate the panel response rate to make video appear more vivid and natural.

- It is best to set **Response Time** to **Standard** or **Faster** when you are not viewing a movie.
- This menu is not available when **PIP/PBP Mode** is set to **On** and the **Size** is set to  /  /  (PIP Mode).

---

## Picture Size

Change the picture size.

- This menu is not available when **PIP/PBP Mode** is set to **On** and the **Size** is set to  (PBP Mode).
- This option is not available when **FreeSync** is enabled.

### In PC mode

- **Auto**: Display the picture according to the aspect ratio of the input source.
- **Wide**: Display the picture in full screen regardless of the aspect ratio of the input source.

### In AV mode

- **4:3**: Display the picture with an aspect ratio of 4:3. Suitable for videos and standard broadcasts.
- **16:9**: Display the picture with an aspect ratio of 16:9.
- **21:9**: Display the picture with an aspect ratio of 21:9.
- **Screen Fit**: Display the picture with the original aspect ratio without cutting off.

- The function may not be supported depending on the ports provided with the product.
- Changing the screen size is available when the following conditions are satisfied.
  - A digital output device is connected using the HDMI/DP cable.
  - The input signal is 480p, 576p, 720p, or 1080p and monitor can display normally (Not every model can support all of these signals.).
  - This can only be set when the external input is connected through HDMI/DP and **PC/AV Mode** is set to **AV**. (**DisplayPort/HDMI**: This option is available when **FreeSync** is disabled)

---

## Screen Adjustment

- This menu is only available when **Picture Size** is set to **Screen Fit** in **AV** Mode.  
When a 480P or 576P or 720P or 1080P signal is input in **AV** mode and the monitor can display normally, select **Screen Fit** to adjust horizontal position in 0-6 levels.

### Configuring H-Position & V-Position

**H-Position**: Move the screen to the left or right.

**V-Position**: Move the screen up or down.

## Calibration Report

The data from this report are measured at the time of shipment.

- The measurements may vary according to the measuring equipment, measuring location, system environment (e.g. computer, graphic board, etc) and other variables.
- Input signal: **HDMI**
- Each measurement from this report is based on the **Custom** mode at the time of shipment.
- This report is not provided on the menu of some products, but in an separate hardcopy report instead.

# Chapter 05

## PIP/PBP

A detailed description of each function is provided. Refer to your product for details.

— The functions available may vary depending on the product model. The color and shape of parts may differ from what is shown. Specifications are subject to change without notice to improve quality.

### PIP/PBP Mode

Enable or disable the **PIP/PBP Mode** function.

The PIP (Picture in Picture) function separates the screen into two parts. One source device is displayed on the main screen at the same time the another source device is displayed in inset windows.

The PBP (Picture by Picture) function separates the screen in half displaying output from two different source devices simultaneously on the left and right sides of the screen.

— **PIP/PBP** mode is compatible with Windows 7, Windows 8, and Windows 10.

— The **PIP/PBP** function may not be available depending on the specifications of the graphics card used. If the screen is blank in **PIP/PBP** mode when the optimum resolution is selected, go to **Control Panel → Display → Screen Resolution** and click **Detect** on the PC. (Instructions are based on Windows 7.)

— The screen may flicker briefly or appear after a delay when you enable or disable the **PIP/PBP** function or when you change the screen size with the **PIP/PBP** function activated.

This can typically arise when a PC and a monitor are connected to two or more input sources. It has nothing to do with the performance of a monitor.

The issue is mainly caused when the video signals are delayed in transmission to the monitor depending on the graphics card performance.

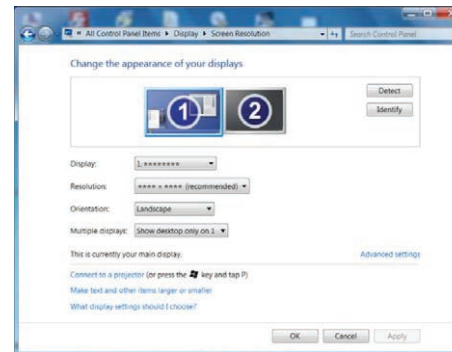

— To maximize the picture quality, it is recommended to use a graphics card that supports WQHD+ (3440 x 1440) resolution.

— When using **PIP/PBP**, automatic switching to the optimum resolution and frequency is not available, due to conformance with the graphics card and Windows. Set **PIP/PBP Mode** to **Off**. Alternatively, restart the monitor, then set the resolution to the optimum setting using the Windows interface.

— If there are several inputs with different vertical frequencies when using **PIP/PBP Mode**, a lower vertical frequency is applied.

For example, if input 1 is 50 Hz and input 2 is 100 Hz, the vertical frequency is set to 50 Hz.





With two 100 Hz input sources in **PIP/PBP Mode**, the vertical frequency maximum is 60 Hz.



---

## Size

Select the size and aspect ratio of the sub-screen.

- : Select the icon image if you want to use PBP mode where the optimum resolution for the left and right sides of the screen is 1720 x 1440 (width x height).
- : Select the icon image if you want to use PIP mode where the optimum resolution for the sub-screen is 720 x 480 (width x height).
- : Select the icon image if you want to use PIP mode where the optimum resolution of the sub-screen is 1280 x 720 (width x height).
- : Select the icon image if you want to use PIP mode where the optimum resolution of the sub-screen is 1720 x 720 (width x height).

## Position

Select the position of the sub-screen from the available options.

-  /  /  / 

— Not available when PBP is selected.

— The screen may flicker if the input signal is unstable.

---

## Sound Source

Set which screen you want to hear the sound for.

— The white area of the icon means that the **Sound Source** comes from the main screen/sub-screen or the left/right screen.

### PIP mode

-  / 

### PBP mode

-  / 

---

## Source

### PIP Mode (available in PIP mode (Size

Select the source for each screen.

- The input source for the main screen changes.
- With the exception of the current input source, the other two input sources can be selected.
- The screen may flicker if the input signal is unstable.
- When the Function Key Guide appears, move the JOG button LEFT to select the  icon and then press the JOG button. The main screen will switch in the order **DisplayPort** → **HDMI** → **Thunderbolt3 / USB-C**.

### PBP Mode (available in PBP mode (Size

Select input sources for the devices displayed on the main and sub screens.

- The input source for the main screen changes.
- The screen may flicker if the input signal is unstable.
- When the input signal of the left and right screens are the same, the operation cannot be performed.
- When the Function Key Guide appears, move the JOG button LEFT to select the  icon and then press the JOG button. The main screen will switch in the order **DisplayPort** → **HDMI** → **Thunderbolt3 / USB-C**.

---

## Picture Size

### PIP Mode (available in PIP mode (Size

Select the image size for sub-screen.

#### In PC mode

- **Auto:** Display the picture according to the aspect ratio of the each screen input source.
- **Wide:** Display the picture in full screen regardless of the aspect ratio of the each screen input source.

#### In AV mode

- **4:3:** Display the picture of the sub-screen with an aspect ratio of 4:3. Suitable for videos and standard broadcasts.
  - **16:9:** Display the picture of the sub-screen with an aspect ratio of 16:9.
  - **Screen Fit:** Display the picture of the sub-screen with the original aspect ratio without cutting anything off.
- The function may not be supported depending on the ports provided with the product.
  - Changing the screen size is available when the following conditions are satisfied.
  - A digital output device is connected using the HDMI/DP cable.
  - The input signal is 480p, 576p, 720p, or 1080p and monitor can display normally (Not every model can support all of these signals.).
  - This can only be set when the external input is connected through HDMI/DP and **PC/AV Mode** is set to **AV**.

---

## PBP Mode (available in PBP mode(Size ))

Set the **Picture Size** for each of the divided screens.

### In PC mode

- **Auto**: Display the picture according to the aspect ratio of the each screen input source.
- **Wide**: Display the picture in full screen regardless of the aspect ratio of the each screen input source.

### In AV mode

- **4:3**: Display the picture of the sub-screen with an aspect ratio of 4:3. Suitable for videos and standard broadcasts.
- **16:9**: Display the picture of the sub-screen with an aspect ratio of 16:9.
- **Screen Fit**: Display the picture of the sub-screen with the original aspect ratio without cutting anything off.

- The function may not be supported depending on the ports provided with the product.
- Changing the screen size is available when the following conditions are satisfied.
- A digital output device is connected using the HDMI/DP cable.
- The input signal is 480p, 576p, 720p, or 1080p and monitor can display normally (Not every model can support all of these signals.).
- This can only be set when the external input is connected through HDMI/DP and **PC/AV Mode** is set to **AV**.

---

## Contrast

### PIP Mode (available in PIP mode(Size / / ))

Adjust the contrast level for sub-screen.

### PBP Mode (available in PBP mode(Size ))

Adjust the contrast level for each screen.

# Chapter 06

## OnScreen Display

A detailed description of each function is provided. Refer to your product for details.

— The functions available may vary depending on the product model. The color and shape of parts may differ from what is shown. Specifications are subject to change without notice to improve quality.

### Transparency

Set the transparency for the menu windows.

### Position

Adjust the menu position.

### Language

Set the menu language.

- A change to the language setting will only be applied to the onscreen menu display.
- It will not be applied to other functions on your PC.

### Display Time

Set the on-screen display (OSD) menu to automatically disappear if the menu is not used for a specified period of time.

**Display Time** can be used to specify the time after which you want the OSD menu to disappear.

# Chapter 07

## System

A detailed description of each function is provided. Refer to your product for details.

— The functions available may vary depending on the product model. The color and shape of parts may differ from what is shown. Specifications are subject to change without notice to improve quality.

### DisplayPort Ver.

Select your Displayport. Displayport 1.1 supports High Bit Rate 1, while 1.2 supports High Bit Rate 2.

- Incorrect settings may cause the screen to go blank. If this occurs, check the device specifications.
- If the monitor is in **HDMI, DisplayPort** or **Thunderbolt3 / USB-C**. mode and the screen says **Check Signal Cable** or power saving mode activates, press the JOG button to display the function-button screen and then select the  icon. You can select **1.1** or **1.2↑**.

### HDMI Mode

Select the HDMI mode to use.

- The supportable device and resolution may differ depending on its version.
- When the version is changed, the screen may blink or the setup window in your PC may be changed.
- When the setting is not appropriate, a blank screen may appear. In this case, check the specifications of the device.
- **1.4:** HDMI 1.4 input is supported. The product supports the vertical frequency up to 50 Hz in the maximum resolution (3440 x 1440).
- **2.0:** HDMI 2.0 input is supported. The product supports the vertical frequency up to 100 Hz in the maximum resolution (3440 x 1440). For use of HDMI 2.0, you must use the graphic card and the standard cable that support HDMI 2.0.

---

# FreeSync

**FreeSync** technology is solution that eliminates screen tearing without all the usual lag and latency.

This feature will eliminate screen tearing and lag during game play. Improve your gaming experience.

— Not available when **PIP/PBP Mode** is set to **On**.

— This feature turns **Off** if **PIP/PBP Mode** is on.

- **Off**: Disable **FreeSync**.
- **Standard Engine**: Enable the basic **FreeSync** functions of the AMD graphics card.
- **Ultimate Engine**: Enable the **FreeSync** feature with a higher screen frame rate. Screen tearing (abnormal sync between the screen and content) is reduced in this mode. Note that screen flickering may occur during game play.

When select **Ultimate Engine** mode, please use maximum screen refresh rate for optimal freesync effect.

The refresh rate setting method please refer to [Q & A → How can I change the frequency?](#)

— For use of the **FreeSync** function, the AMD graphic card and driver that support the function must have been installed. For use of the **FreeSync** function in HDMI input, the AMD graphic card and driver that support HDMI 2.0 must have been installed and the version in the product must have been set as HDMI 2.0.

— The **FreeSync** function is only enabled in **HDMI** or **DisplayPort** mode.

Use the HDMI/DisplayPort cable provided by the manufacturer when using **FreeSync**.

If you use the **FreeSync** function while playing a game, the following symptoms may occur:

- The screen may flicker depending on the type of graphics card, the game option settings, or the video being played. Try the following actions: decrease the game setting values, change the current **FreeSync** mode to **Standard Engine**, or visit the AMD website to check your graphics driver's version and update it with the latest one.
- While you are using the **FreeSync** function, the screen may flicker due to variation of the output frequency from the graphics card.
- The response rate during the game may fluctuate depending on the resolution. A higher resolution generally decreases the response rate.
- The sound quality of the monitor may be degraded.

— If you encounter any issues when using the function, contact the Samsung Service Center.

---

## The models in the Graphic Cards list supports FreeSync

**FreeSync** can only be used with specific AMD graphics card models. Refer to the following list for supported graphics cards:

Make sure to install the latest official graphics drivers from AMD that support **FreeSync**.

— For additional AMD graphics card models that support the **FreeSync** feature, visit the official AMD website.

— Select **FreeSync Off** if you are using a graphics card from a different manufacturer.

- AMD Radeon R9 300 Series
- AMD Radeon R9 Fury X
- AMD Radeon R7 360
- AMD Radeon R9 295X2
- AMD Radeon R9 290X
- AMD Radeon R9 290
- AMD Radeon R9 285
- AMD Radeon R7 260X
- AMD Radeon R7 260
- AMD Radeon RX 400 Series
- AMD Radeon RX 500 Series
- AMD RX VEGA Series

## How do you enable FreeSync?

1 Set **FreeSync** to **Standard Engine** or **Ultimate Engine** in the OSD menu.

2 Enable **FreeSync** in AMD Radeon Settings:

Right-click the mouse → AMD Radeon Settings → Display

The "AMD FreeSync" feature should be set to "On". Select to "On" if not already enabled.

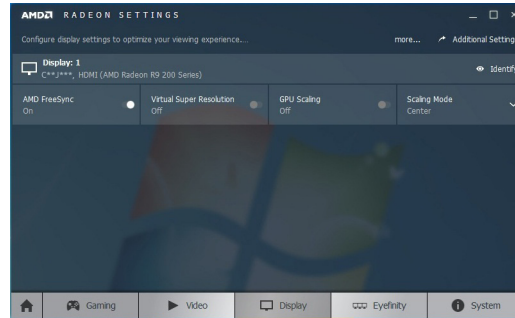
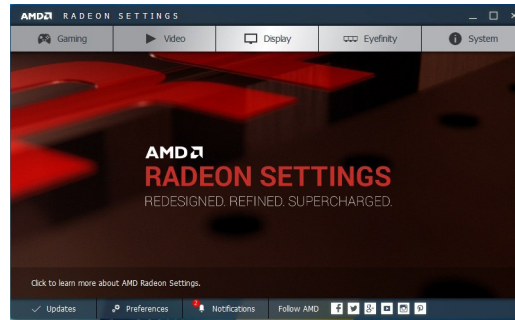
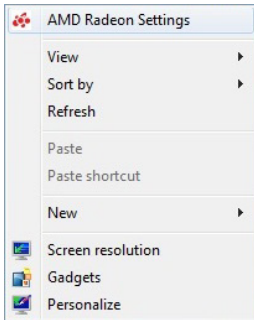

## Eco Saving Plus

Reduce energy consumption compared to consumption at the maximum brightness level.

- This option is not available when **SAMSUNG MAGICBright** is in **Dynamic Contrast** mode.
- This menu is not available when **Game Mode** is enabled.
- This menu is not available when **Eye Saver Mode** is enabled.
- Not available when **PIP/PBP Mode** is set to **On**.

- **Off**: Deactivate the **Eco Saving Plus** function.
- **Auto**: The power consumption will automatically be reduced by about 10% over the current setting. (The reduction of power consumption depends on the customer screen brightness condition.)
- **Low**: Saves up to 25 % energy compared to the maximum brightness.
- **High**: Saves up to 50 % energy compared to the maximum brightness.

## Off Timer

**Off Timer**: Turn on **Off Timer** mode.

**Turn Off After**: The off timer can be set within a range of 1 to 23 hours. The product will automatically power off after the specified number of hours.

- This option is only available when **Off Timer** is set to **On**.
- For products for the market in some regions, the **Off Timer** is set to automatically activate 4 hours after the product powers on. This is done in accordance with power supply regulations. If you do not want the timer to activate, go to **III** → **System** and set **Off Timer** to **Off**.

---

## PC/AV Mode

Set **PC/AV Mode** to **AV**. The picture size will be enlarged.

This option is useful when you view a movie.

- Set to **PC** when connected to a PC.
- Set to **AV** when connected to an AV device.

— This feature is only available on the widescreen models that include 16:9, 16:10 and 21:9.

— If the monitor is in **HDMI**, **DisplayPort** or **Thunderbolt3 / USB-C** mode and the screen says **Check Signal Cable** or power saving mode activates, press the JOG button to display the function-button screen and then select the  icon. You can select **PC** or **AV**.

## Source Detection

Select either **Auto** or **Manual** as the method to recognize input signal.

— Not available when **PIP/PBP Mode** is set to **On**.

## USB Hub

Set whether to use the USB hub or not.

- **Off**: **USB Hub** can't be available.
- **On**: **USB Hub** can be available.

— Actual models because of functional variation maybe haven't this function.

— Please make sure to connect with the only one thunderbolt device when changing **USB Hub** condition.

---

## Key Repeat Time

**Acceleration**, **1 sec**, or **2 sec** can be selected. If **No Repeat** is selected, a command responds only once when a button is pressed.

## Power LED On

Configure the settings to enable or disable the power LED located at the lower part of the product.

- **Working**: The power LED is on when the product is turned on.
- **Stand-by**: The power LED is on when the product is turned off.

## Reset All

Return all the settings for the product to the default factory settings.

## Information

View the current input source, frequency and resolution.



# Chapter 08

## Installing the Software

### Easy Setting Box



Easy Setting Box enables users to use the monitor by partitioning multiple sections.

To install the latest version of Easy Setting Box, download it from the Samsung Electronics website at <http://www.samsung.com>.

- The software may not work properly if you do not restart the computer after the installation.
- The Easy Setting Box icon may not appear depending on the computer system and the product specifications.
- If the shortcut icon does not appear, press the F5 key.

### Restrictions and Problems with the Installation

The Easy Setting Box installation may be affected by the Graphics Card, Motherboard and the Networking Environment.

### System Requirements

OS	Hardware
• Windows 7 32Bit/64Bit	• At least 32MB of memory
• Windows 8 32Bit/64Bit	• At least 60MB of free space on the hard disk drive
• Windows 8.1 32Bit/64Bit	
• Windows 10 32Bit/64Bit	

# Chapter 09

## Troubleshooting Guide

### Requirements Before Contacting Samsung Customer Service Center

— Before calling Samsung Customer Service Center, test your product as follows. If the problem persists, contact Samsung Customer Service Center.

### Testing the Product

Check if your product is operating normally by using the product test function.

If the screen is turned off and the power indicator blinks even though the product is properly connected to a PC, perform a self-diagnosis test.

- 1 Power off both the PC and product.
- 2 Disconnect the cables from the product.
- 3 Power on the product.
- 4 If the message **Check Signal Cable** appears, the product is working normally.

— If the screen remains blank, check the PC system, video controller and cable.

### Checking the Resolution and Frequency

For a mode that exceeds the supported resolution(refer to [Standard Signal Mode Table](#)), the message **Not Optimum Mode** will appear for a short time.

— The displayed resolution may vary, depending on the computer system settings and cables.

### Check the following.

#### Installation issue (PC mode)

---

The screen keeps switching on and off.

Check the cable connection between the product and PC, and ensure the connectors are locked.

---

Blank spaces are found on all four sides of the screen when an HDMI or HDMI-DVI cable is connected to the product and PC.

The blank spaces found on the screen have nothing to do with the product.

Blank spaces on the screen are caused by the PC or graphics card. To resolve the problem, adjust the screen size in the HDMI or DVI settings for the graphics card.

If the graphics card settings menu does not have an option to adjust the screen size, update the graphics card driver to the latest version.

(Please contact the graphics card or computer manufacturer for further details about how to adjust the screen settings.)

---

#### Screen issue

---

The power LED is off. The screen will not switch on.

Check that the power cable is connected properly.

---

The message **Check Signal Cable** appears.

Check that the cable is properly connected to the product.

Check that the device connected to the product is powered on.

---

---

**Not Optimum Mode** is displayed.

This message appears when the signal from the graphics card exceeds the maximum resolution or frequency for the product.

Change the maximum resolution and frequency to suit the product performance, referring to Standard Signal Mode Table (P.46).

---

**The images on the screen look distorted.**

Check the cable connection to the product.

---

**The screen is not clear. The screen is blurry.**

Remove any accessories (video extension cable, etc.) and try again.

Set the resolution and frequency to the recommended level.

---

**The screen appears unstable and shaky. There are shadows or ghost images left on the screen.**

Check that the resolution and frequency for the PC are within the range of resolution and frequency compatible with the product. Next, if required, change the settings, referring to Standard Signal Mode Table (P.46) in this manual and the **Information** menu on the product.

---

**The screen is too bright. The screen is too dark.**

Adjust **Brightness** and **Contrast**.

---

**Screen color is inconsistent.**

Change the **Color** settings.

---

**The colors on the screen have a shadow and are distorted.**

Change the **Color** settings.

---

**White does not really look white.**

Change the **Color** settings.

---

**There is no image on the screen and the power LED blinks every 0.5 to 1 second.**

The product is operating in power-saving mode.

Press any key on the keyboard or move the mouse to return to normal operating mode.

---

**Text is blurry.**

If using a Windows OS (e.g. Windows 7, Windows 8, Windows 8.1 or Windows 10): Go to **Control Panel** → **Fonts** → **Adjust ClearType text** and change **Turn on ClearType**.

---

**Video playback is choppy.**

Playback of high-definition large video files can be choppy. This may be because the video player is not optimized for the computer resource.

Try playing the file on another video player.

---

---

**Sound issue**

---

**There is no sound.**

Check the connection of the audio cable or adjust the volume.

Check the volume.

---

**The volume is too low.**

Adjust the volume.

If the volume is still low after turning it up to the maximum level, adjust the volume on your PC sound card or software Program.

---

**Video is available but there is no sound.**

Sound cannot be heard if a HDMI-DVI cable is used to connect the input device.

Connect the device using an HDMI cable or a DP cable.

---

---

**Source device issue**

---

**A beeping sound is heard when my PC is booting.**

If a beeping sound is heard when your PC is booting, have your PC serviced.

---

---

## Q & A

— Refer to the user manual for your PC or graphics card for further instructions on adjustment.

---

### How can I change the frequency?

Set the frequency on your graphics card.

- Windows 7: Go to Control Panel → Appearance and Personalization → Display → Screen Resolution → Advanced settings → Monitor, and adjust Refresh rate under Monitor settings.
- Windows 8(Windows 8.1): Go to Settings → Control Panel → Appearance and Personalization → Display → Screen Resolution → Advanced settings → Monitor, and adjust Refresh rate under Monitor settings.
- Windows 10: Go to Settings → System → Display → Advanced display settings → Display adapter properties → Monitor, and adjust Screen refresh rate under Monitor settings.

---

### How can I change the resolution?

- Windows 7: Go to Control Panel → Appearance and Personalization → Display → Adjust Resolution, and adjust the resolution.
- Windows 8(Windows 8.1): Go to Settings → Control Panel → Appearance and Personalization → Display → Adjust Resolution, and adjust the resolution.
- Windows 10: Go to Settings → System → Display → Advanced display settings, and adjust the resolution.

---

### How do I set power-saving mode?

- Windows 7: Set power-saving mode in Control Panel → Appearance and Personalization → Personalize → Screen Saver Settings → Power options or BIOS SETUP on the PC.
  - Windows 8(Windows 8.1): Set power-saving mode in Settings → Control Panel → Appearance and Personalization → Personalize → Screen Saver Settings → Power options or BIOS SETUP on the PC.
  - Windows 10: Set power-saving mode in Settings → Personalization → Lock screen → Screen timeout settings → Power & sleep or BIOS SETUP on the PC.
-

# Chapter 10

## Specifications

### General

<b>Model Name</b>	<b>C34J791WT*</b>
<b>Size</b>	34 Class (34.0 Inches / 86.4 cm)
<b>Display area</b>	797.22 mm (H) x 333.72 mm (V) 31.39 Inches (H) x 13.14 Inches (V)
<b>Pixel Pitch</b>	0.23175 mm (H) x 0.23175 mm (V) 0.009124 Inches (H) x 0.009124 Inches (V)
<b>Maximum Pixel Clock</b>	550 MHz
<b>Power Supply</b>	AC100-240V~ 50/60Hz Based on the AC voltage of the adapter. For the DC voltage of the product, refer to the product label.
<b>Signal connectors</b>	HDMI, DisplayPort, Thunderbolt
<b>Environmental conditions</b>	<b>Operating</b> Temperature: 50 °F – 104 °F (10 °C – 40 °C) Humidity: 10 % – 80 %, non-condensing <b>Storage</b> Temperature: -4 °F – 113 °F (-20 °C – 45 °C) Humidity: 5 % – 95 %, non-condensing

#### Plug-and-Play

This monitor can be installed and used with any Plug-and-Play compatible systems. Two-way data exchange between the monitor and PC system optimizes the monitor settings. Monitor installation takes place automatically. However, you can customize the installation settings if desired.

#### Panel Dots (Pixels)

Due to the nature of the manufacturing of this product, approximately 1 pixel per million (1ppm) may be brighter or darker on the LCD panel. This does not affect product performance.

#### The above specifications are subject to change without notice to improve quality.

#### This device is a Class B digital apparatus.

#### For detailed device specifications, visit the Samsung Electronics website.

#### (USA only)

Dispose unwanted electronics through an approved recycler.

To find the nearest recycling location, go to our website:

[www.samsung.com/recyclingdirect](http://www.samsung.com/recyclingdirect) or call, 1-800-SAMSUNG

## Standard Signal Mode Table

Synchronization	Horizontal Frequency	30 – 152 kHz
	Vertical Frequency	50 – 100 Hz
Resolution	Optimum resolution	3440 x 1440 @ 50 Hz (HDMI)
		3440 x 1440 @ 60 Hz (DisplayPort, Thunderbolt)
	Maximum resolution	3440 x 1440 @ 100 Hz

If a signal that belongs to the following standard signal modes is transmitted from your PC, the screen will automatically be adjusted. If the signal transmitted from the PC does not belong to the standard signal modes, the screen may be blank even though the power LED turns on. In such a case, change the settings according to the following table by referring to the graphics card user manual.

Resolution	Horizontal Frequency (kHz)	Vertical Frequency (Hz)	Pixel Clock (MHz)	Sync Polarity (H/V)
IBM, 720 x 400	31.469	70.087	28.322	-/+
VESA, 640 x 480	31.469	59.940	25.175	-/-
MAC, 640 x 480	35.000	66.667	30.240	-/-
VESA, 640 x 480	37.861	72.809	31.500	-/-
VESA, 640 x 480	37.500	75.000	31.500	-/-
VESA, 800 x 600	35.156	56.250	36.000	+/+
VESA, 800 x 600	37.879	60.317	40.000	+/+
VESA, 800 x 600	48.077	72.188	50.000	+/+
VESA, 800 x 600	46.875	75.000	49.500	+/+
MAC, 832 x 624	49.726	74.551	57.284	-/-
VESA, 1024 x 768	48.363	60.004	65.000	-/-
VESA, 1024 x 768	56.476	70.069	75.000	-/-
VESA, 1024 x 768	60.023	75.029	78.750	+/+
VESA, 1152 x 864	67.500	75.000	108.000	+/+
MAC, 1152 x 870	68.681	75.062	100.000	-/-
VESA, 1280 x 720	45.000	60.000	74.250	+/+

Resolution	Horizontal Frequency (kHz)	Vertical Frequency (Hz)	Pixel Clock (MHz)	Sync Polarity (H/V)
VESA, 1280 x 800	49.702	59.810	83.500	-/+
VESA, 1280 x 1024	63.981	60.020	108.000	+/+
VESA, 1280 x 1024	79.976	75.025	135.000	+/+
VESA, 1440 x 900	55.935	59.887	106.500	-/+
VESA, 1600 x 900 RB	60.000	60.000	108.000	+/+
VESA, 1680 x 1050	65.290	59.954	146.250	-/+
VESA, 1920 x 1080	67.500	60.000	148.500	+/+
CEA, 2560 x 1080	66.000	60.000	198.000	+/+
VESA, 2560 x 1440 RB	88.787	59.951	241.500	+/-
VESA, 3440 x 1440 (50 Hz)	73.681	49.987	265.250	+/-
VESA, 3440 x 1440 (DP)	88.819	59.973	319.750	+/-
VESA, 3440 x 1440 (DP, HDMI2.0)	150.972	99.982	543.500	+/-

Horizontal Frequency

The time required to scan a single line from the left to the right side of the screen is called a horizontal cycle. The reciprocal number of a horizontal cycle is called horizontal frequency. Horizontal frequency is measured in kHz.

Vertical Frequency

Repeating the same picture dozens of times per second allows you to view natural pictures. The repeat frequency is called "vertical frequency" or "refresh rate" and is indicated in Hz.

This product can be set to only one resolution for each screen size to obtain the optimum picture quality due to the nature of the panel. Using a resolution other than the specified resolution may degrade the picture quality. To avoid this, it is recommended that you select the optimum resolution specified for your product.

Optimum settings may be restricted, depending on the performance and version of the graphics card and cable (HDMI / DisplayPort version, etc.)

# Chapter 11

## Appendix

### Responsibility for the Pay Service (Cost to Customers)

— When the service is requested, in spite of in warranty, we may charge you for a visit from a service technician in the following cases.

#### Not a product defect

Cleaning of the product, Adjustment, Explanation, Re-installation and etc.

- If a service technician gives instructions on how to use product or simply adjusts options without disassembling product.
- If a defect is caused by external environmental factors (Internet, Antenna, Wired Signal, etc.)
- If a product is reinstalled or devices are connected additionally after installing the purchased product for the first time.
- If a product is reinstalled to move to a different spot or to move to a different house.
- If customer requests instructions on how to use because of another company's product.
- If customer requests instructions on how to use the network or another company's Program.
- If customer requests software installation and setup for the product.
- If a service technician removes/cleans dusts or foreign materials inside of the product.
- If customer requests an installation additionally after purchasing a product through home-shopping or online.

### A Product damage caused by customer's fault

Product damage caused by customer's mishandling or wrong repair

If a product damage is caused by;

- External impact or drop.
- Use of supplies or separately sold product unspecified by Samsung.
- Repair from a person besides an engineer of outsourcing service company or partner of Samsung Electronics Co., Ltd.
- Remodeling or repairing the product by customer.
- Using it with incorrect voltage or non-authorized electrical connections.
- Not following the "cautions" in User Manual.

#### Others

- If product fails by natural disaster. (lightning, fire, earthquake, flood damage, etc)
- If consumable components are all used up. (Battery, Toner, Fluorescent lights, Head, Vibrator, Lamp, Filter, Ribbon, etc.)

— If customer requests a service in case the product has no defect, service fee may be charged. So please read User Manual first.