

User Manual

S27E330H

The color and the appearance may differ depending on the product, and the specifications are subject to change without prior notice to improve the performance.

The contents of this manual are subject to change without notice to improve quality.

© Samsung Electronics

Samsung Electronics owns the copyright for this manual.

Use or reproduction of this manual in parts or entirety without the authorization of Samsung Electronics is prohibited.

Trademarks other than that of Samsung Electronics are owned by their respective owners.

- An administration fee may be charged if either
 - (a) an engineer is called out at your request and there is no defect in the product (i.e. where you have failed to read this user manual).
 - (b) you bring the unit to a repair center and there is no defect in the product (i.e. where you have failed to read this user manual).
- The amount of such administration charge will be advised to you before any work or home visit is carried out.

Table of contents

Before Using the Product

Securing the Installation Space	4
Precautions for storage	4
Safety Precautions	4
Symbols	4
Cleaning	5
Electricity and Safety	5
Installation	6
Operation	7

Preparations

Parts	9
Control Panel	9
Direct Key guide	10
Function Key Guide	11
Changing Brightness, Contrast and Sharpness settings	12
Reverse Side	13
Adjusting the Product Tilt	13
Anti-theft Lock	14
Installing a Wall-mount Kit or Desktop Stand	15
Installation	16
Attaching the Stand	16
Removing the Stand	17

Connecting and Using a Source Device

Pre-connection Checkpoints	18
Connecting and Using a PC	18
Connection Using the D-SUB Cable (Analog Type)	18
Connection Using the HDMI Cable	19
Connection Using an HDMI-DVI Cable	19
Connecting the Power	19
Correct posture to use the product	20
Driver Installation	21
Setting Optimum Resolution	21

Screen Setup

Brightness	22
Contrast	22
Sharpness	22
Eye Saver Mode	23
Game Mode	23
SAMSUNG MAGIC Bright	23
SAMSUNG MAGIC Angle	24
SAMSUNG MAGIC Upscale	24
Image Size	24
HDMI Black Level	25

Response Time	25
H-Position & V-Position	25
Coarse	25
Fine	25

Configuring Tint

Red	26
Green	26
Blue	26
Color Tone	27
Gamma	27

Resizing or Relocating the Screen

Language	28
Menu H-Position & Menu V-Position	28
Display Time	28
Transparency	28

Table of contents

Setup and Reset

Reset All	29
Eco Saving Plus	29
Off Timer	30
PC/AV Mode	30
Key Repeat Time	30
Source Detection	30
Power LED On	30
INFORMATION	31

Installing the Software

Easy Setting Box	32
------------------	----

Troubleshooting Guide

Requirements Before Contacting Samsung Customer Service Center	33
Testing the Product	33
Checking the Resolution and Frequency	33
Check the following.	33
Q & A	35

Specifications

General	36
Standard Signal Mode Table	37

Appendix

Responsibility for the Pay Service (Cost to Customers)	39
Not a product defect	39
A Product damage caused by customer's fault	39
Others	39

Chapter 01

Before Using the Product

Securing the Installation Space

Ensure some space around the product for ventilation. An internal temperature rise may cause fire and damage the product. Be sure to allow the amount of space as shown below or greater when installing the product.

— The exterior may differ depending on the product.

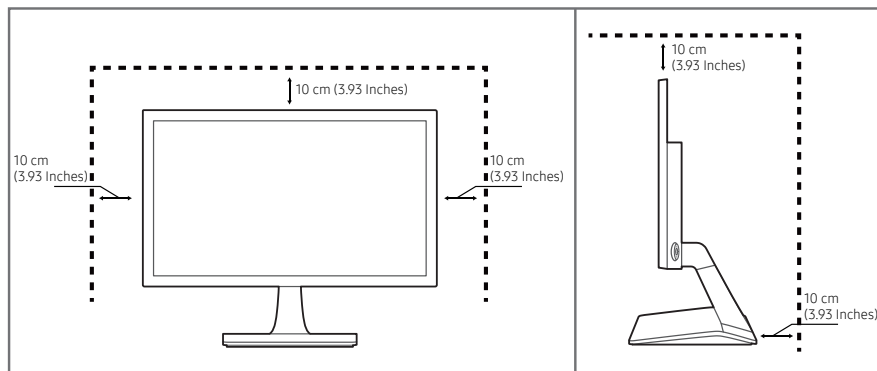

Precautions for storage

High-glossy models can develop white stains on the surface if an ultrasonic wave humidifier is used nearby.

— Contact your nearest Samsung Customer Service Center if you want to clean the inside of the product (Service fee will be charged.)

Safety Precautions

Caution

RISK OF ELECTRIC SHOCK DO NOT OPEN

Caution : TO REDUCE THE RISK OF ELECTRIC SHOCK, DO NOT REMOVE COVER. (OR BACK)

THERE ARE NO USER SERVICEABLE PARTS INSIDE.

REFER ALL SERVICING TO QUALIFIED PERSONNEL.

This symbol indicates that high voltage is present inside.

It is dangerous to make any kind of contact with any internal part of this product.

This symbol alerts you that important literature concerning operation and maintenance has been included with this product.



Symbols

Warning

A serious or fatal injury may result if instructions are not followed.

Caution

Personal injury or damage to properties may result if instructions are not followed.

Cleaning

- Exercise care when cleaning as the panel and exterior of advanced LCDs are easily scratched.
 - Take the following steps when cleaning.
- 1 Power off the product and computer.
 - 2 Disconnect the power cord from the product.
 - Hold the power cable by the plug and do not touch the cable with wet hands. Otherwise, an electric shock may result.
 - 3 Wipe the monitor with a clean, soft and dry cloth.
 - Do not apply a cleaning agent that contains alcohol, solvent, or surfactant to the monitor.
 - Do not spray water or detergent directly on the product.
 - 4 Wet a soft and dry cloth in water and wring thoroughly to clean the exterior of the product.
 - 5 Connect the power cord to the product when cleaning is finished.
 - 6 Power on the product and computer.

Electricity and Safety

Warning

- Do not use a damaged power cord or plug, or a loose power socket.
- Do not use multiple products with a single power socket.
- Do not touch the power plug with wet hands.
- Insert the power plug all the way in so it is not loose.
- Connect the power plug to a grounded power socket (type 1 insulated devices only).
- Do not bend or pull the power cord with force. Be careful not to leave the power cord under a heavy object.
- Do not place the power cord or product near heat sources.
- Clean any dust around the pins of the power plug or the power socket with a dry cloth.

Caution

- Do not disconnect the power cord while the product is being used.
- Only use the power cord provided with your product by Samsung. Do not use the power cord with other products.
- Keep the power socket where the power cord is connected unobstructed.
 - The power cord must be disconnected to cut off power to the product when an issue occurs.
- Hold the plug when disconnecting the power cord from the power socket.

Installation

Warning

- DO NOT PLACE CANDLES, INSECT REPELLANTS OR CIGARETTES ON TOP OF THE PRODUCT. DO NOT INSTALL THE PRODUCT NEAR HEAT SOURCES.
- Do not install the product in poorly ventilated spaces such as a bookcase or closet.
- Install the product at least 10 cm away from the wall to allow ventilation.
- Keep the plastic packaging out of the reach of children.
 - Children may suffocate.
- Do not install the product on an unstable or vibrating surface (insecure shelf, sloped surface, etc.)
 - The product may fall and become damaged and/or cause an injury.
 - Using the product in an area with excess vibration may damage the product or cause a fire.
- Do not install the product in a vehicle or a place exposed to dust, moisture (water drips, etc.), oil, or smoke.
- Do not expose the product to direct sunlight, heat, or a hot object such as a stove.
 - The product lifespan may be reduced or a fire may result.
- Do not install the product within the reach of young children.
 - The product may fall and injure children.
- Edible oil (such as soybean oil) may damage or distort the product. Keep the product away from oil pollution. And do not install or use the product in the kitchen or near the kitchen stove.

Caution

- Do not drop the product while moving.
- Do not set down the product on its front.
- When installing the product on a cabinet or shelf, make sure that the bottom edge of the front of the product is not protruding.
 - The product may fall and become damaged and/or cause an injury.
 - Install the product only on cabinets or shelves of the right size.
- Set down the product gently.
 - Product failure or personal injury may result.
- Installing the product in an unusual place (a place exposed to a lot of fine dust, chemical substances, extreme temperatures or a significant presence of moisture, or a place where the product will operate continuously for an extended period of time) may seriously affect its performance.
 - Be sure to consult Samsung Customer Service Center if you want to install the product at such a place.

Operation

Warning

- There is a high voltage inside the product. Never disassemble, repair or modify the product yourself.
 - Contact Samsung Customer Service Center for repairs.
- To move the product, first disconnect all the cables from it, including the power cable.
- If the product generates abnormal sounds, a burning smell or smoke, disconnect the power cord immediately and contact Samsung Customer Service Center.
- Do not let children hang from the product or climb on top of it.
 - Children may become injured or seriously harmed.
- If the product is dropped or the outer case is damaged, turn off the power and disconnect the power cord. Then contact Samsung Customer Service Center.
 - Continued use can result in a fire or electric shock.
- Do not leave heavy objects or items that children like (toys, sweets, etc.) on top of the product.
 - The product or heavy objects may fall as children try to reach for the toys or sweets resulting in a serious injury.
- During a lightning or thunderstorm, power off the product and remove the power cable.
- Do not drop objects on the product or apply impact.
- Do not move the product by pulling the power cord or any cable.
- If a gas leakage is found, do not touch the product or power plug. Also, ventilate the area immediately.
- Do not lift or move the product by pulling the power cord or any cable.
- Do not use or keep combustible spray or an inflammable substance near the product.
- Ensure the vents are not blocked by tablecloths or curtains.
 - An increased internal temperature may cause a fire.
- Do not insert metallic objects (chopsticks, coins, hairpins, etc) or objects that burn easily (paper, matches, etc) into the product (via the vent or input/output ports, etc).
 - Be sure to power off the product and disconnect the power cord when water or other foreign substances have entered the product. Then contact Samsung Customer Service Center.
- Do not place objects containing liquid (vases, pots, bottles, etc) or metallic objects on top of the product.
 - Be sure to power off the product and disconnect the power cord when water or other foreign substances have entered the product. Then contact Samsung Customer Service Center.

Caution

- Leaving the screen fixed on a stationary image for an extended period of time may cause afterimage burn-in or defective pixels.
 - Activate power-saving mode or a moving-picture screen saver if you will not be using the product for an extended period of time.
 - Disconnect the power cord from the power socket if you do not plan on using the product for an extended period of time (vacation, etc).
 - Dust accumulation combined with heat can cause a fire, electric shock or electric leakage.
 - Use the product at the recommended resolution and frequency.
 - Your eyesight may deteriorate.
 - Do not put AC/DC adapters together.
 - Remove the plastic bag from the AC/DC adapter before you use it.
 - Do not let water enter the power device or get the device wet.
 - An electric shock or fire may result.
 - Avoid using the product outdoors where it can be exposed to rain or snow.
 - Be careful not to get the AC/DC adapter wet when you wash the floor.
 - Do not put the AC/DC adapter near to any heating apparatus.
 - Otherwise, a fire may result.
 - Keep the AC/DC adapter in a well-ventilated area.
 - If you place the AC/DC power adapter so that it is hanging with the cord input facing upwards, water or other foreign substances could enter the Adapter and cause the Adapter to malfunction. Make sure to rest the AC/DC power adapter flat on a table or the floor.
 - Do not hold the product upside-down or move it by holding the stand.
 - The product may fall and become damaged or cause an injury.
 - Looking at the screen too close for an extended period of time can deteriorate your eyesight.
 - Do not use humidifiers or stoves around the product.
 - Rest your eyes for more than 5 minutes for every 1 hour of product use.
- Do not touch the screen when the product has been turned on for an extended period of time as it will become hot.
 - Store small accessories out of the reach of children.
 - Exercise caution when adjusting the product angle or stand height.
 - Your hand or finger may get stuck and injured.
 - Tilting the product at an excessive angle may cause the product to fall and an injury may result.
 - Do not place heavy objects on the product.
 - Product failure or personal injury may result.

Chapter 02

Preparations

Parts

Control Panel

- The color and shape of parts may differ from what is shown. Specifications are subject to change without notice to improve quality.
- To activate the button on the product, press the  /  /  /  /  etching position exactly. Press the other position may cause wrong action.

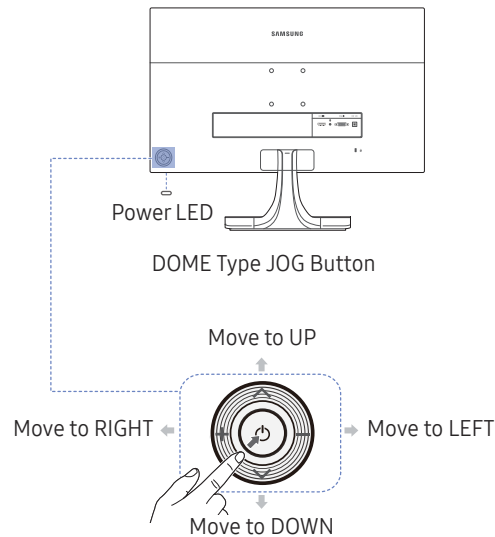

PRESS(Power on, Confirm selection)

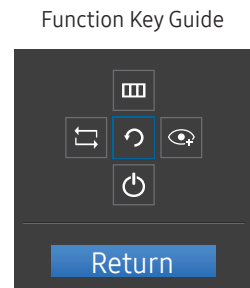

Icons	Description
Power LED	<p>This LED is power status indicator and works as</p> <ul style="list-style-type: none"> Power On (Power button): Off Power saving mode: Blinking Power Off (Power button): On <p>The power Indicator operation can be swapped by changing in the menu. (SETUP&RESET → Power LED On) Actual models because of functional variation maybe haven't this function.</p>
Function Key Guide	<p>Press the  button when the screen is turned on. The Function Key Guide will appear. To access the onscreen menu when the guide is displayed, press the corresponding direction button again.</p> <p>Function Key Guide may vary depending on the function or product model. Please refer to the actual product.</p>

Direct Key guide





— The shortcut button screen (OSD menu) shown below is displayed only when the monitor screen is turned on, the computer resolution changes, or the input source changes.

— The function buttons page shows if **Eye Saver Mode** is enabled.

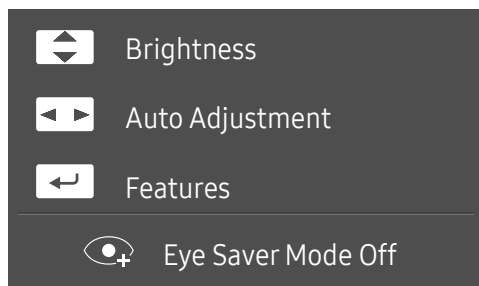
 : On

 : Off









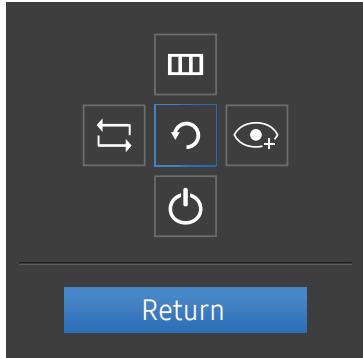











- Press  /  button : Adjust **Brightness, Contrast, Sharpness**.
- Press  /  button : Adjust the screen settings automatically.
 - Changing the resolution in Display Properties will activate the **Auto Adjustment** function.
 - This function is only available in **Analog** mode.
- Press  button : Display Function Key Guide.

Function Key Guide

To enter the main menu or to use other items, press the  button to display the Function Key Guide. You can exit by pressing the  button again.



Press  /  /  /  button: Move to the item you want. The description for each item will appear when the focus changes.
Press  button: The selected item will be applied.

Icons	Description
	Selects  to change the input signal by moving the  button in the Function Key Guide screen. A message will appear on the top left corner of the screen if the input signal has been changed.
	Selects  by moving the  button on the function key guide screen. The OSD (On Screen Display) of your Monitor's feature appears. OSD control lock: Maintain the current settings, or lock the OSD control to prevent unintended changes to settings. Enable/Disable: To lock/unlock the OSD control, press the  button for 10 seconds when the main menu displayed. If the OSD control is locked, Brightness and Contrast can be adjusted. Eye Saver Mode is available. SETUP&RESET → Power LED On is available. INFORMATION can be viewed.
	Selects  by moving the  button on the function key guide screen. Press to enable or disable Eye Saver Mode . The items below are not available if the Eye Saver Mode function is enable. <ul style="list-style-type: none"> PICTURE → Brightness, Game Mode, MAGICBright, MAGICAngle COLOR SETUP&RESET → Eco Saving Plus
	Selects  to turn the Monitor off by moving the  button on the function key guide screen.

Actual models because of functional variation, Function key guide options will be different.

When the monitor displays nothing (i.e. Power saving mode or Non-signal mode), 2 direct keys for control source and power could be used as below.

DOMe Type JOG Button	Power saving/Non-signal mode
^	Source Change
∇	
PRESS  button for 2 seconds	Power Off

When the monitor displays the Main menu the JOG Button could be used as below.

DOMe Type JOG Button	Action
^ / ∇	Move the option
—	Exit the Main menu. Close Sublist without saving value. Value decreases in the slider.
+	Move to next depth. Value increases in the slider.
	Move to next depth. Save the value and close Sublist.

Changing Brightness, Contrast and Sharpness settings

When the shortcut button page is displayed, adjust the **Brightness**, **Contrast** and **Sharpness** from the initial screen using the DOMe Type JOG Button.



— The displayed image may differ depending on the model.

— The default brightness can vary depending on the region.

Brightness

— This menu is not available when **SAMSUNG MAGICBright** is set to **Dynamic Contrast** mode.

— This menu is not available when **Eco Saving Plus** is enabled.

— This menu is not available when **Eye Saver Mode** is enabled.

Contrast

— This menu is not available when **SAMSUNG MAGICBright** is in **Cinema** or **Dynamic Contrast** mode.

— This menu is not available when **Game Mode** is enabled.

Sharpness

— This menu is not available when **SAMSUNG MAGICBright** is in **Cinema** or **Dynamic Contrast** mode.

— This menu is not available when **Game Mode** is enabled.

Reverse Side

The color and shape of parts may differ from what is shown. Specifications are subject to change without notice to improve quality.

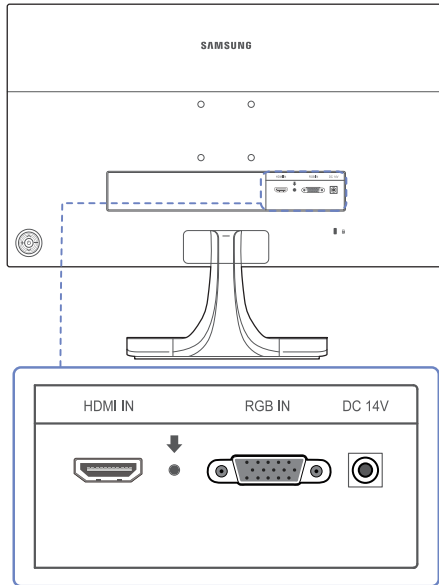

Port

Description

HDMI IN



Connects to a source device using an HDMI cable or HDMI-DVI cable.

RGB IN

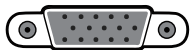

Connect to a PC using the D-SUB cable.

DC 14V



Connects to the AC/DC adapter.

Adjusting the Product Tilt

The color and shape of parts may differ from what is shown. Specifications are subject to change without notice to improve quality.

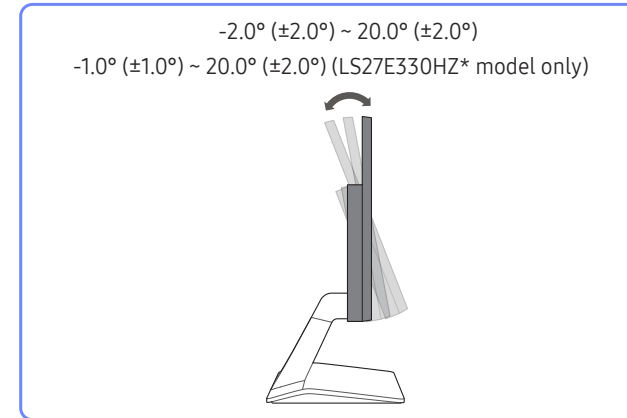

- You can adjust the product tilt.
- Hold the lower part of the product and adjust the tilt carefully.

Anti-theft Lock

- An anti-theft lock allows you to use the product securely even in public places.
- The locking device shape and locking method depend on the manufacturer. Refer to the user guide provided with your anti-theft locking device for details. The lock device is sold separately.

To lock an anti-theft locking device:

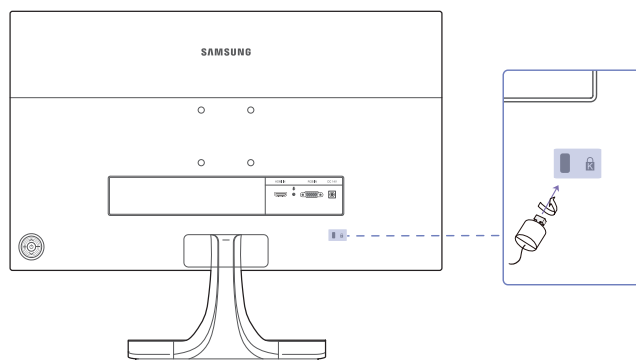

- 1 Fix the cable of your anti-theft locking device to a heavy object such as a desk.
- 2 Put one end of the cable through the loop on the other end.
- 3 Insert the locking device into the anti-theft lock slot at the back of the product.
- 4 Lock the locking device.
 - An anti-theft locking device can be purchased separately.
 - Refer to the user guide provided with your anti-theft locking device for details.
 - Anti-theft locking devices can be purchased at electronics retailers or online.

Installing a Wall-mount Kit or Desktop Stand

— Power the product off and remove the power cable from the power socket.

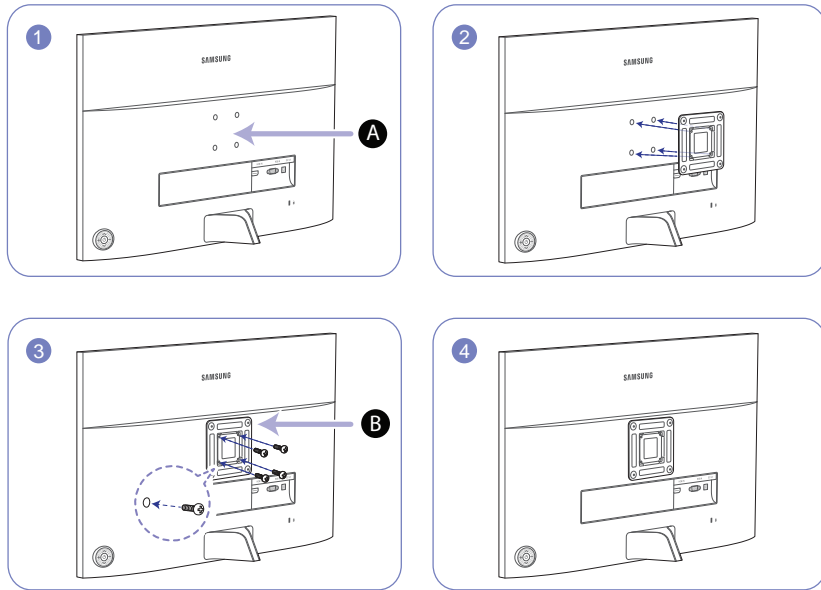

A Attach the wall-mount kit or desktop stand here

B Bracket (sold separately)

Align the grooves and tightly fasten the screws on the bracket on the product with the corresponding parts on the wall-mount kit or desktop stand you want to attach.

• Notes

- Using a screw longer than the standard length can damage the internal components of the product.
- The length of screws required for a wall mount that does not comply with the VESA standards may vary depending on the specifications.
- Do not use screws that do not comply with the VESA standards. Do not attach the wall-mount kit or desktop stand using excessive force. The product may get damaged or fall and cause personal injury. Samsung shall not be held liable for any damage or injury caused by using improper screws or attaching the wall-mount kit or desktop stand using excessive force.
- Samsung shall not be held liable for any product damage or personal injury caused by using a wall-mount kit other than the one specified or from an attempt to install the wall-mount kit on your own.
- To mount the product on a wall, ensure you purchase a wall-mount kit that can be installed 10 cm or farther away from the wall.
- Be sure to use a wall-mount kit that complies with the standards.
- To install the monitor using a wall mount, disconnect the stand base from the monitor.

Unit: mm (inches)

Model name	VESA screw hole specs in millimeters	Standard Screw	Quantity
S27E330H	75.0 x 75.0 (3.0 x 3.0)	M4	4

— Do not install your Wall Mount Kit while your product is turned on. It may result in personal injury due to electric shock.

Installation

Attaching the Stand

— Before assembling the product, place the product down on a flat and stable surface so that the screen is facing downwards.

— The exterior may differ depending on the product.

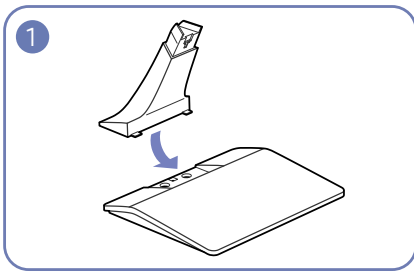

Insert the stand neck into the stand base in the direction shown in the figure.

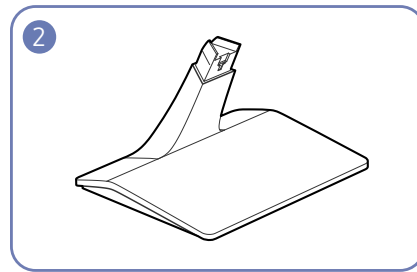

Check that the stand neck is firmly connected.

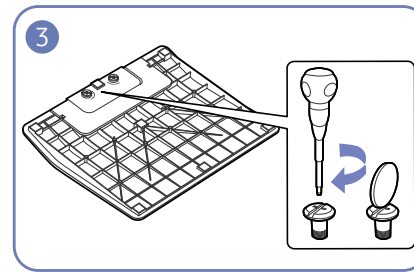

Tightly fasten the connecting screw at the bottom of the stand base.

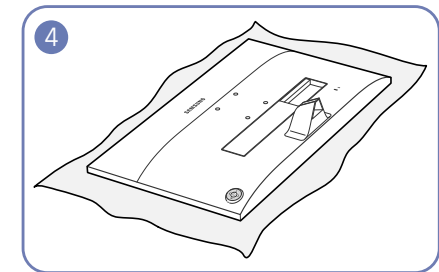

Place a soft cloth over the table to protect the product and place the product onto the cloth so that the front of the product is facing downwards.

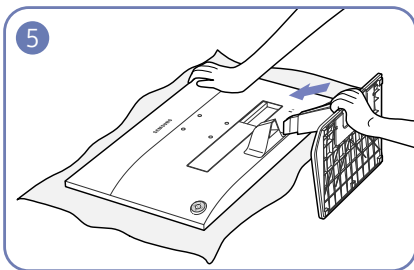

Insert the stand head into the connection hole in the direction, as shown in the figure.

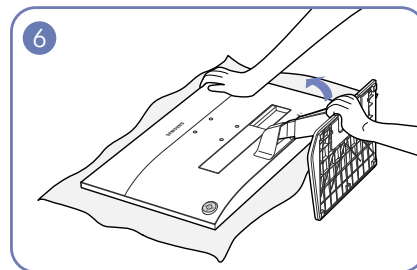

Hold the main body of the product with your hand, as shown in the figure. Hold and rotate the assembled stand until it fits exactly into the stop position.

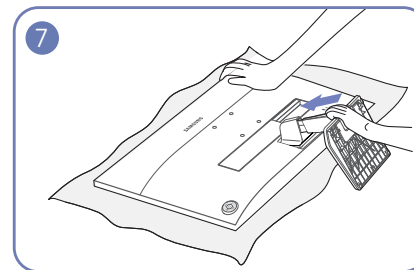

Push the assembled stand into the main body in the direction of the arrow, as shown in the figure.

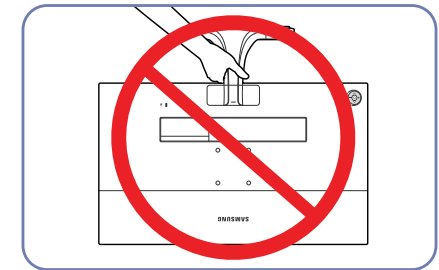

- Caution
Do not hold the product upside down only by the stand.

Removing the Stand

- Before assembling the product, place the product down on a flat and stable surface so that the screen is facing downwards.
- The exterior may differ depending on the product.

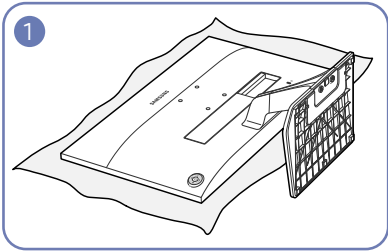

Place a soft cloth over the table to protect the product and place the product onto the cloth so that the front of the product is facing downwards.

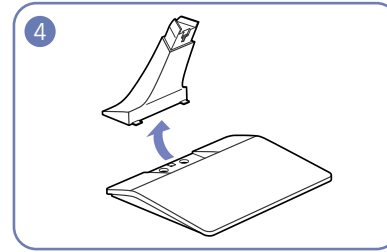

Remove the stand neck from the stand base by pulling it in the direction of the arrow as shown in the figure.

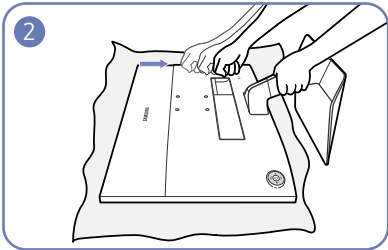

While holding the stand neck with one hand, pound the other fisted hand down onto the top of the stand base in the direction of the arrow to detach the stand base.

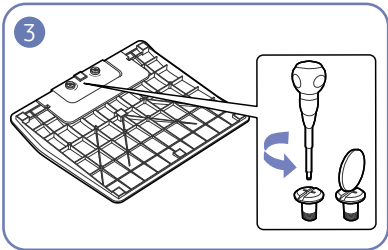

Turn the connecting screw at the bottom of the stand base to separate it.

Chapter 03

Connecting and Using a Source Device

Pre-connection Checkpoints

- Before connecting a source device, read the user manual provided with it.
The number and locations of ports on source devices may differ from device to device.
- Do not connect the power cable before connecting all other cables.
Ensure you connect a source device first before connecting the power cable.
Connecting the power cable during connection may damage the product.
- Check the types of ports at the back of the product you want to connect.

Connecting and Using a PC

- Select a connection method suitable for your PC.
- Connecting parts may differ in different products.
 - Provided ports may vary depending on the product.

Connection Using the D-SUB Cable (Analog Type)

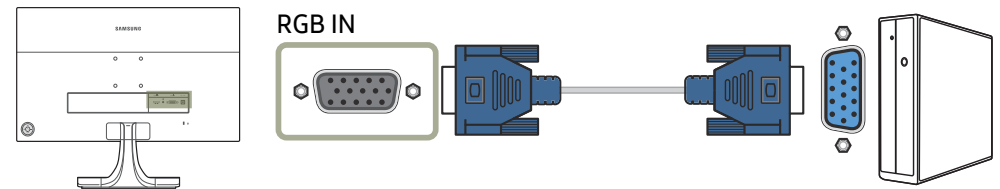

Connection Using the HDMI Cable

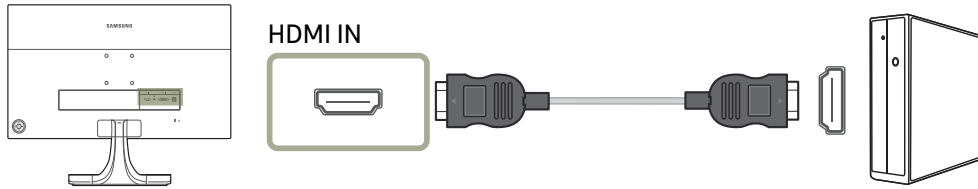

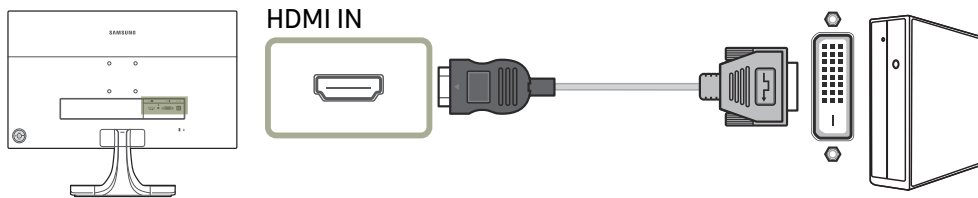

Connection Using an HDMI-DVI Cable

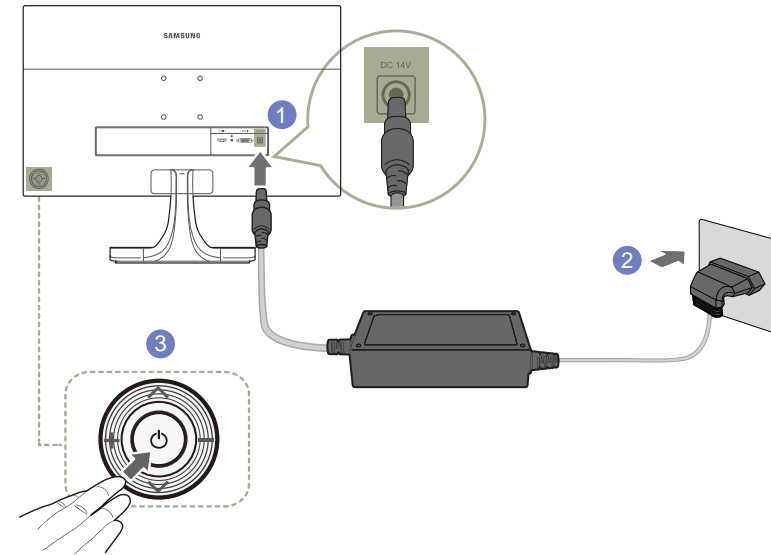

Connecting the Power

Power connection using integrated AC/DC adapter



- 1 Connect the AC/DC adapter to the DC 14V port on the back of the monitor.
- 2 Next, connect the power cable to the power outlet.
- 3 Press the  button on the back of the monitor to turn it on.
— The input voltage is switched automatically.

Power connection using detachable AC/DC adapter

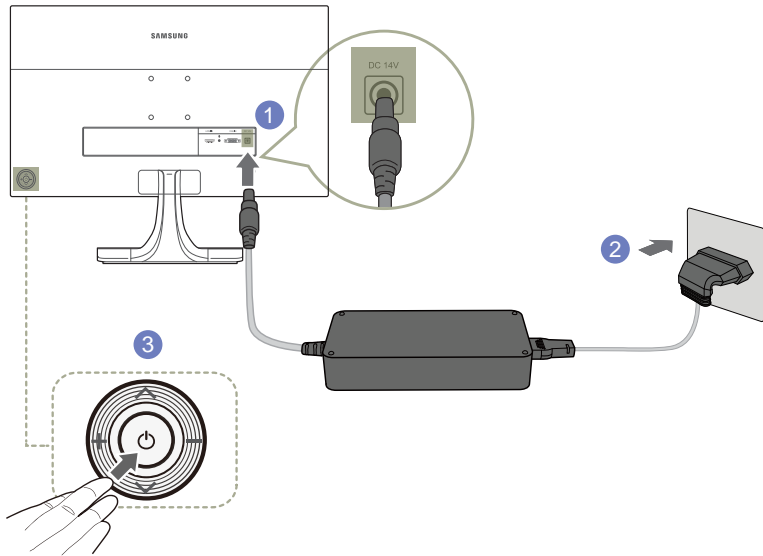

- 1 Connect the power cable to the AC/DC adapter. Then, connect the AC/DC adapter to the DC 14V port on the back of the product.
 - 2 Next, connect the power cable to the power outlet.
 - 3 Press the  button on the back of the monitor to turn it on.
- The input voltage is switched automatically.

Correct posture to use the product



Use the product in the correct posture as follows:

- Straighten your back.
- Adjust the angle so light does not reflect on the screen.
- Keep your forearms perpendicular to your upper arms and level with the back of your hands.
- Keep your elbows at about a right angle.
- Adjust the height of the product so you can keep your knees bent at 90 degrees or more, your heels attached to the floor, and your arms lower than your heart.

Driver Installation

- You can set the optimum resolution and frequency for this product by installing the corresponding drivers.
- To install the latest version of the product driver, download it from the Samsung Electronics website at <http://www.samsung.com>.

Setting Optimum Resolution

An information message about setting optimum resolution will appear if you power on the product for the first time after purchase.

Select a language on the product and change the resolution on your PC to the optimum setting.

- If the optimum resolution is not selected, the message will appear up to three times for a specified time even when the product is turned off and on again.
- The optimum resolution can also be selected in Control Panel on your PC.

Chapter 04

Screen Setup

Configure the screen settings such as brightness.

A detailed description of each function is provided. Refer to your product for details.

The functions available may vary depending on the product model. Refer to the actual product.

Brightness

You can adjust the general brightness of the picture. (Range: 0~100)

A higher value will make the picture appear brighter.

- This menu is not available when **SAMSUNG MAGICBright** is set to **Dynamic Contrast** mode.
- This menu is not available when **Eco Saving Plus** is enabled.
- This menu is not available when **Eye Saver Mode** is enabled.

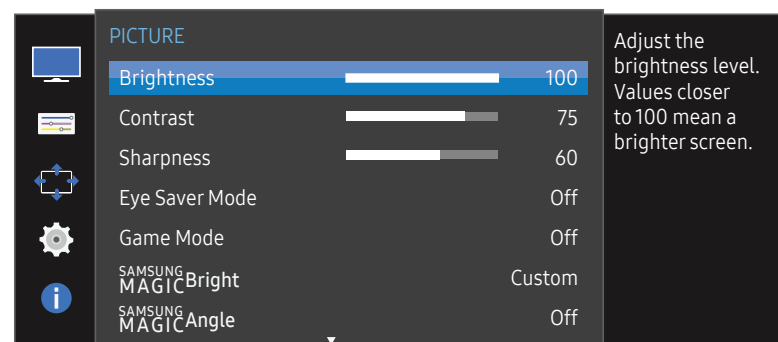

- The displayed image may differ depending on the model.

Contrast

Adjust the contrast between the objects and background. (Range: 0~100)

A higher value will increase the contrast to make the object appear clearer.

- This option is not available when **SAMSUNG MAGICBright** is in **Cinema** or **Dynamic Contrast** mode.
- This menu is not available when **Game Mode** is enabled.

Sharpness

Make the outline of objects more clear or blurry. (Range: 0~100)

A higher value will make the outline of objects clearer.

- This option is not available when **SAMSUNG MAGICBright** is in **Cinema** or **Dynamic Contrast** mode.
- This menu is not available when **SAMSUNG MAGICUpscale** is in **Mode1** or **Mode2** mode.
- This menu is not available when **Game Mode** is enabled.

Eye Saver Mode

Set to an optimum picture quality suitable for eye relaxation.

TÜV Rheinland “Low Blue Light Content” is a certification for products which meet requirements for lower blue light levels. When **Eye Saver Mode** is 'On', the blue light that wavelength is around 400nm will decrease, and it will provide an optimum picture quality suitable for eye relaxation. At the same time, the blue light level is lower than in the default settings, and it was tested by TÜV Rheinland and certified as it met the requirements of TÜV Rheinland “Low Blue Light Content” standards.

Game Mode

Configure the product screen settings for game mode.

Use this feature when playing games on a PC or when a game console such as PlayStation™ or Xbox™ is connected.

- This menu is not available when **Eye Saver Mode** is enabled.
- When the monitor turns off, enters power-saving mode or changes input sources, **Game Mode** turns **Off** even if it is set to **On**.
- If you want to keep **Game Mode** enabled all the time, select **Always On**.

SAMSUNG MAGIC Bright

This menu provides an optimum picture quality suitable for the environment where the product will be used.

- This menu is not available when **Eco Saving Plus** is enabled.
- This menu is not available when **Game Mode** is enabled.
- This menu is not available when **Eye Saver Mode** is enabled.

You can customize the brightness to suit your preferences.

In PC mode

- **Custom**: Customize the contrast and brightness as required.
- **Standard**: Obtain a picture quality suitable for editing documents or using Internet.
- **Cinema**: Obtain the brightness and sharpness of TVs suitable for enjoying video and DVD content.
- **Dynamic Contrast**: Obtain balanced brightness through automatic contrast adjustment.

In AV mode

When the external input is connected through HDMI and **PC/AV Mode** is set to **AV**, **SAMSUNG MAGIC Bright** has four automatic picture settings (**Dynamic**, **Standard**, **Movie** and **Custom**) that are preset at the factory. You can activate either **Dynamic**, **Standard**, **Movie** or **Custom**. You can select **Custom** which automatically recalls your personalized picture settings.

- **Dynamic**: Select this mode to view a sharper image than in **Standard** mode.
- **Standard**: Select this mode when the surroundings are bright. This also provides a sharp image.
- **Movie**: Select this mode when the surroundings are dark. This will save power and reduce eye fatigue.
- **Custom**: Select this mode when you want to adjust the image according to your preferences.

SAMSUNG MAGIC Angle

SAMSUNG MAGIC Angle allows you to configure the settings to obtain the optimum picture quality according to your viewing angle.

- This menu is not available when **SAMSUNG MAGIC Bright** is set to **Cinema** or **Dynamic Contrast** mode.
- This menu is not available when **Game Mode** or **Eye Saver Mode** is enabled.

You can customize the angle to suit your preferences.

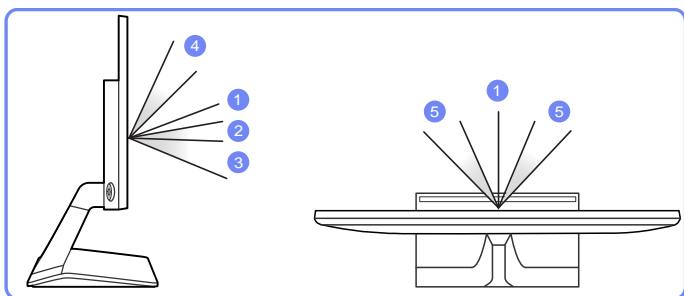

- **Off** ①: Select this option to view directly in front of the product.
- **Lean Back Mode 1** ②: Select this option to view from a place slightly lower than the product.
- **Lean Back Mode 2** ③: Select this option to view from a place lower than **Lean Back Mode 1**.
- **Standing Mode** ④: Select this option to view from a place higher than the product.
- **Side Mode** ⑤: Select this option to view from either side of the product.
- **Group View**: Select this option for more than one viewer to view from places ①, ④, and ⑤.
- **Custom**: **Lean Back Mode 1** will be applied by default if **Custom** is selected.

SAMSUNG MAGIC Upscale

SAMSUNG MAGIC Upscale function can enhance the layers of the picture details and the vividness of the picture.

The function has more obvious effects on low-resolution pictures.

- This menu is not available when **SAMSUNG MAGIC Bright** is set to **Cinema** or **Dynamic Contrast** mode.
- This menu is not available when **Game Mode** is enabled.

- **Off / Mode1 / Mode2**
 - Comparing with **Mode1, Mode2** has a stronger effect.

Image Size

Change the picture size.

In PC mode

- **Auto**: Display the picture according to the aspect ratio of the input source.
- **Wide**: Display the picture in full screen regardless of the aspect ratio of the input source.

In AV mode

- **4:3**: Display the picture with an aspect ratio of 4:3. Suitable for videos and standard broadcasts.
- **16:9**: Display the picture with an aspect ratio of 16:9.
- **Screen Fit**: Display the picture with the original aspect ratio without cutting off.
- The function may not be supported depending on the ports provided with the product.
- Changing the screen size is available when the following conditions are satisfied.
 - A digital output device is connected using the HDMI cable.
 - The input signal is 480p, 576p, 720p, or 1080p and monitor can display normally (Not every model can support all of these signals.).
 - This can only be set when the external input is connected through HDMI and **PC/AV Mode** is set to **AV**.

HDMI Black Level

If a DVD player or set-top box is connected to the product via HDMI, image quality degradation (contrast/color degradation, black level, etc.) may occur, depending on the connected source device. In such case, **HDMI Black Level** can be used to adjust the image quality.

If this is the case, correct the degraded picture quality using **HDMI Black Level**.

— This function is only available in **HDMI** mode.

- **Normal**: Select this mode when there is no contrast ratio degradation.
- **Low**: Select this mode to reduce the black level and increase the white level when there is a contrast ratio degradation.

— **HDMI Black Level** may not be compatible with some source devices.

Response Time

Accelerate the panel response rate to make video appear more vivid and natural.

— It is best to set **Response Time** to **Standard** or **Faster** when you are not viewing a movie.

H-Position & V-Position

H-Position: Move the screen to the left or right.

V-Position: Move the screen up or down.

— This menu is available in **Analog** mode only.

— This menu is only available when **Image Size** is set to **Screen Fit** in **AV** Mode.

When a 480P or 576P or 720P or 1080P signal is input in **AV** mode and the monitor can display normally, select **Screen Fit** to adjust horizontal position in 0-6 levels.

Coarse

Adjust the screen frequency.

— This menu is available in **Analog** mode only.

Fine

Fine-adjust the screen to obtain a vivid picture.

— This menu is available in **Analog** mode only.

Chapter 05

Configuring Tint

A detailed description of each function is provided. Refer to your product for details.

Adjust the tint of the screen. This menu is not available when **SAMSUNG MATHIA Bright** is in **Cinema** or **Dynamic Contrast** mode. This menu is not available when **Game Mode** or **Eye Saver Mode** is enabled.

The functions available may vary depending on the product model. Refer to the actual product.

Red

Adjust the value of the color red in the picture. (Range: 0~100)

A higher value will increase the intensity of the color.

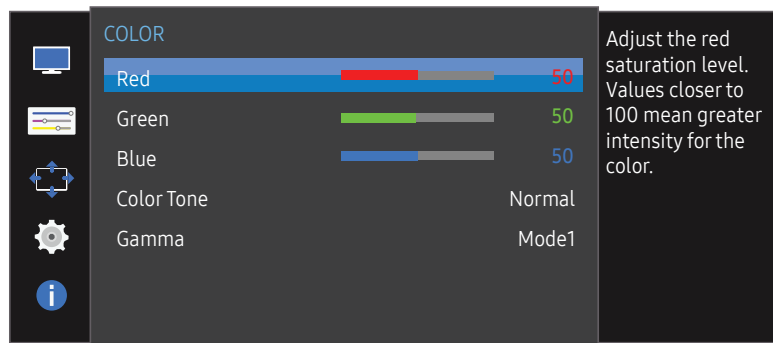

— The displayed image may differ depending on the model.

Green

Adjust the value of the color green in the picture. (Range: 0~100)

A higher value will increase the intensity of the color.

Blue

Adjust the value of the color blue in the picture. (Range: 0~100)

A higher value will increase the intensity of the color.

Color Tone

Adjust the general color tone of the picture.

- **Cool 2**: Set the color temperature to be cooler than **Cool 1**.
- **Cool 1**: Set the color temperature to be cooler than **Normal** mode.
- **Normal**: Display the standard color tone.
- **Warm 1**: Set the color temperature to be warmer than **Normal** mode.
- **Warm 2**: Set the color temperature to be warmer than **Warm 1**.
- **Custom**: Customize the color tone.

— When the external input is connected through HDMI and **PC/AV Mode** is set to **AV**, **Color Tone** has four color temperature settings (**Cool**, **Normal**, **Warm** and **Custom**).

Gamma

Adjust the mid-range brightness (Gamma) for the picture.

- **Mode1 / Mode2 / Mode3**

Chapter 06

Resizing or Relocating the Screen

A detailed description of each function is provided. Refer to your product for details.
The functions available may vary depending on the product model. Refer to the actual product.

Language

Set the menu language.

- A change to the language setting will only be applied to the onscreen menu display.
- It will not be applied to other functions on your PC.

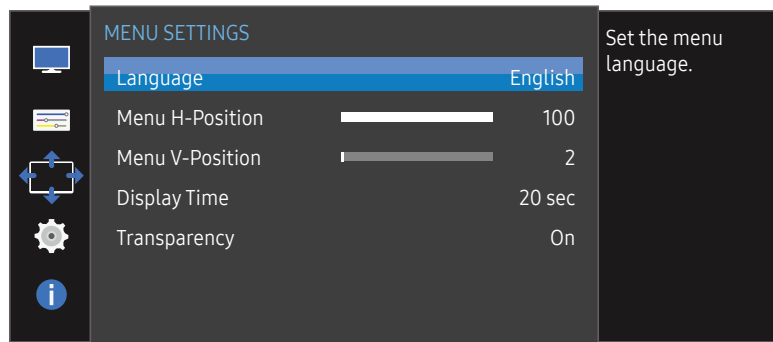

- The displayed image may differ depending on the model.

Menu H-Position & Menu V-Position

Menu H-Position: Move the menu position to the left or right.

Menu V-Position: Move the menu position up or down.

Display Time

Set the on-screen display (OSD) menu to automatically disappear if the menu is not used for a specified period of time.

Display Time can be used to specify the time after which you want the OSD menu to disappear.

Transparency

Set the transparency for the menu windows.

Chapter 07

Setup and Reset

A detailed description of each function is provided. Refer to your product for details.
The functions available may vary depending on the product model. Refer to the actual product.

Reset All

Return all the settings for the product to the default factory settings.

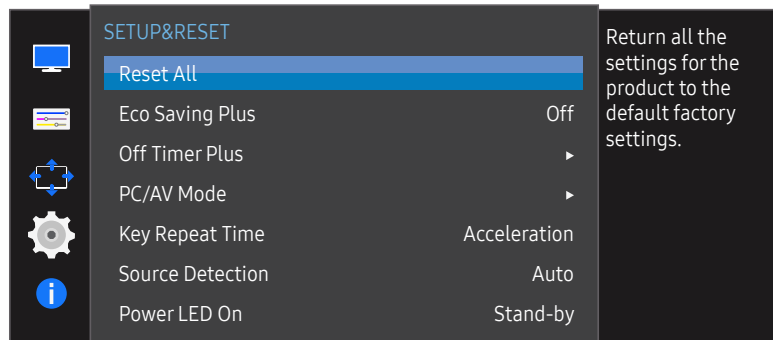

— The displayed image may differ depending on the model.

Eco Saving Plus

Reduce energy consumption compared to consumption at the maximum brightness level.

— This option is not available when **SAMSUNG MAGICBright** is in **Dynamic Contrast** mode.

— This menu is not available when **Eye Saver Mode** is enabled.

— This menu is not available when **Game Mode** is enabled.

- **Off**: Deactivate the **Eco Saving Plus** function.
- **Auto**: The power consumption will automatically be reduced by about 10% over the current setting. (The reduction of power consumption depends on the customer screen brightness condition.)
- **Low**: Saves up to 25 % energy compared to the maximum brightness.
- **High**: Saves up to 50 % energy compared to the maximum brightness.

Off Timer

Off Timer: Turn on **Off Timer** mode.

Turn Off After: The off timer can be set within a range of 1 to 23 hours. The product will automatically power off after the specified number of hours.

- This option is only available when **Off Timer** is set to **On**.
- For products for the market in some regions, the **Off Timer** is set to automatically activate 4 hours after the product powers on. This is done in accordance with power supply regulations. If you do not want the timer to activate, go to MENU → **SETUP&RESET** and set **Off Timer** to **Off**.

PC/AV Mode

Set **PC/AV Mode** to **AV**. The picture size will be enlarged.

This option is useful when you view a movie.

- Set to **PC** when connected to a PC.
- Set to **AV** when connected to an AV device.

- This function does not support **Analog** mode.
- Supplied for the wide models only such as 16:9 or 16:10.
- If the monitor (when set to HDMI) is in power saving mode or is displaying the message **Check Signal Cable**, press the **MENU** button to display the On Screen Display(OSD). You can select **PC** or **AV**.

Key Repeat Time

Control the response rate of a button when the button is pressed.

Acceleration, **1 sec**, or **2 sec** can be selected. If **No Repeat** is selected, a command responds only once when a button is pressed.

Source Detection

Select either **Auto** or **Manual** as the method to recognize input signal.

Power LED On

Configure the settings to enable or disable the power LED located at the lower part of the product.

- **Working:** The power LED is on when the product is turned on.
- **Stand-by:** The power LED is on when the product is turned off.

INFORMATION

View the current input source, frequency and resolution.

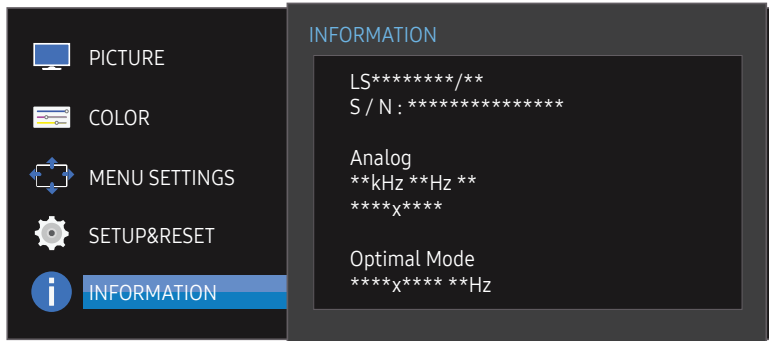

— The displayed image may differ depending on the model.

Chapter 08

Installing the Software

Easy Setting Box



Easy Setting Box

Easy Setting Box enables users to use the monitor by partitioning multiple sections.

To install the latest version of **Easy Setting Box**, download it from the Samsung Electronics website at <http://www.samsung.com>.

- The software may not work properly if you do not restart the computer after the installation.
- The Easy Setting Box icon may not appear depending on the computer system and the product specifications.
- If the shortcut icon does not appear, press the F5 key.

Restrictions and Problems with the Installation

The **Easy Setting Box** installation may be affected by the Graphics Card, Motherboard and the Networking Environment.

System Requirements

OS	Hardware
<ul style="list-style-type: none">• Windows XP 32Bit/64Bit• Windows Vista 32Bit/64Bit• Windows 7 32Bit/64Bit• Windows 8 32Bit/64Bit• Windows 8.1 32Bit/64Bit• Windows 10 32Bit/64Bit	<ul style="list-style-type: none">• At least 32MB of memory• At least 60MB of free space on the hard disk drive

Chapter 09

Troubleshooting Guide

Requirements Before Contacting Samsung Customer Service Center

— Before calling Samsung Customer Service Center, test your product as follows. If the problem persists, contact Samsung Customer Service Center.

Testing the Product

Check if your product is operating normally by using the product test function.

If the screen is turned off and the power indicator blinks even though the product is properly connected to a PC, perform a self-diagnosis test.

- 1 Power off both the PC and product.
- 2 Disconnect the cables from the product.
- 3 Power on the product.
- 4 If the message **Check Signal Cable** appears, the product is working normally.

— If the screen remains blank, check the PC system, video controller and cable.

Checking the Resolution and Frequency

For a mode that exceeds the supported resolution (refer to [Standard Signal Mode Table](#)), the message **Not Optimum Mode** will appear for a short time.

— The displayed resolution may vary, depending on the computer system settings and cables.

Check the following.

Installation issue (PC mode)

The screen keeps switching on and off.

Check the cable connection between the product and PC, and ensure the connectors are locked.

Blank spaces are found on all four sides of the screen when an HDMI or HDMI-DVI cable is connected to the product and PC.

The blank spaces found on the screen have nothing to do with the product.

Blank spaces on the screen are caused by the PC or graphics card. To resolve the problem, adjust the screen size in the HDMI or DVI settings for the graphics card.

If the graphics card settings menu does not have an option to adjust the screen size, update the graphics card driver to the latest version.

(Please contact the graphics card or computer manufacturer for further details about how to adjust the screen settings.)

Screen issue

The power LED is off. The screen will not switch on.

Check that the power cable is connected properly.

The message **Check Signal Cable appears.**

Check that the cable is properly connected to the product.

Check that the device connected to the product is powered on.

Not Optimum Mode is displayed.

This message appears when the signal from the graphics card exceeds the maximum resolution or frequency for the product.

Change the maximum resolution and frequency to suit the product performance, referring to Standard Signal Mode Table (P.37).

The images on the screen look distorted.

Check the cable connection to the product.

The screen is not clear. The screen is blurry.

Adjust **Coarse** and **Fine**.

Remove any accessories (video extension cable, etc.) and try again.

Set the resolution and frequency to the recommended level.

The screen appears unstable and shaky. There are shadows or ghost images left on the screen.

Check that the resolution and frequency for the PC are within the range of resolution and frequency compatible with the product. Next, if required, change the settings, referring to Standard Signal Mode Table (P.37) in this manual and the **INFORMATION** menu on the product.

The screen is too bright. The screen is too dark.

Adjust **Brightness** and **Contrast**.

Screen color is inconsistent.

Change the **COLOR** settings.

The colors on the screen have a shadow and are distorted.

Change the **COLOR** settings.

White does not really look white.

Change the **COLOR** settings.

There is no image on the screen and the power LED blinks every 0.5 to 1 second.

The product is operating in power-saving mode.

Press any key on the keyboard or move the mouse to return to normal operating mode.

Text is blurry.

If using a Windows OS (e.g. Windows 7, Windows 8, Windows 8.1 or Windows 10): Go to **Control Panel** → **Fonts** → **Adjust ClearType text** and change **Turn on ClearType**.

Video playback is choppy.

Playback of high-definition large video files can be choppy. This may be because the video player is not optimized for the computer resource.

Try playing the file on another video player.

Source device issue

A beeping sound is heard when my PC is booting.

If a beeping sound is heard when your PC is booting, have your PC serviced.

— The LED lights on the frame of the product may be seen depending on the user's viewing angle. The light is harmless to people and has no bearing on product features and performance. The product is safe to use.

Q & A

— Refer to the user manual for your PC or graphics card for further instructions on adjustment.

How can I change the frequency?

Set the frequency on your graphics card.

- Windows XP: Go to Control Panel → Appearance and Themes → Display → Settings → Advanced → Monitor, and adjust Refresh rate under Monitor settings.
 - Windows ME/2000: Go to Control Panel → Display → Settings → Advanced → Monitor, and adjust Refresh rate under Monitor settings.
 - Windows Vista: Go to Control Panel → Appearance and Personalization → Personalization → Display Settings → Advanced Settings → Monitor, and adjust Refresh rate under Monitor settings.
 - Windows 7: Go to Control Panel → Appearance and Personalization → Display → Screen Resolution → Advanced settings → Monitor, and adjust Refresh rate under Monitor settings.
 - Windows 8(Windows 8.1): Go to Settings → Control Panel → Appearance and Personalization → Display → Screen Resolution → Advanced settings → Monitor, and adjust Refresh rate under Monitor settings.
 - Windows 10: Go to Settings → System → Display → Advanced display settings → Display adapter properties → Monitor, and adjust Screen refresh rate under Monitor settings.
-

How can I change the resolution?

- Windows XP: Go to Control Panel → Appearance and Themes → Display → Settings, and adjust the resolution.
 - Windows ME/2000: Go to Control Panel → Display → Settings, and adjust the resolution.
 - Windows Vista: Go to Control Panel → Appearance and Personalization → Personalize → Display Settings, and adjust the resolution.
 - Windows 7: Go to Control Panel → Appearance and Personalization → Display → Adjust Resolution, and adjust the resolution.
 - Windows 8(Windows 8.1): Go to Settings → Control Panel → Appearance and Personalization → Display → Adjust Resolution, and adjust the resolution.
 - Windows 10: Go to Settings → System → Display → Advanced display settings, and adjust the resolution.
-

How do I set power-saving mode?

- Windows XP: Set power-saving mode in Control Panel → Appearance and Themes → Display → Screen Saver Settings → Power options or BIOS SETUP on the PC.
 - Windows ME/2000: Set power-saving mode in Control Panel → Display → Screen Saver Settings → Power options or BIOS SETUP on the PC.
 - Windows Vista: Set power-saving mode in Control Panel → Appearance and Personalization → Personalize → Screen Saver Settings → Power options or BIOS SETUP on the PC.
 - Windows 7: Set power-saving mode in Control Panel → Appearance and Personalization → Personalize → Screen Saver Settings → Power options or BIOS SETUP on the PC.
 - Windows 8(Windows 8.1): Set power-saving mode in Settings → Control Panel → Appearance and Personalization → Personalize → Screen Saver Settings → Power options or BIOS SETUP on the PC.
 - Windows 10: Set power-saving mode in Settings → Personalization → Lock screen → Screen timeout settings → Power & sleep or BIOS SETUP on the PC.
-

Chapter 10

Specifications

General

Model Name	S27E330H
Size	27 Class (27 Inches / 68 cm)
Display area	597.6 mm (H) x 336.15 mm (V) 23.5 Inches (H) x 13.2 Inches (V)
Pixel Pitch	0.3114 mm (H) x 0.3114 mm (V) 0.01226 Inches (H) x 0.01226 Inches (V)
Maximum Pixel Clock	148.5 MHz (Analog, HDMI)
Power Supply	AC 100 - 240 V – (+/- 10%), 50/60 Hz ± 3 Hz Refer to the label at the back of the product as the standard voltage can vary in different countries.
Signal connectors	D-SUB, HDMI
Environmental conditions	Operating Temperature: 50 °F – 104 °F (10 °C – 40 °C) / Humidity: 10% – 80%, non-condensing Storage Temperature: -4 °F – 113 °F (-20 °C – 45 °C) / Humidity: 5% – 95%, non-condensing

Plug-and-Play

This monitor can be installed and used with any Plug-and-Play compatible systems. Two-way data exchange between the monitor and PC system optimizes the monitor settings. Monitor installation takes place automatically. However, you can customize the installation settings if desired.

Panel Dots (Pixels)

Due to the nature of the manufacturing of this product, approximately 1 pixel per million (1ppm) may be brighter or darker on the LCD panel. This does not affect product performance.

The above specifications are subject to change without notice to improve quality.

This device is a Class B digital apparatus.

For detailed device specifications, visit the Samsung Electronics website.

(USA only)

Dispose unwanted electronics through an approved recycler.

To find the nearest recycling location, go to our website: www.samsung.com/recyclingdirect or call, (877) 278 - 0799

Standard Signal Mode Table

Model Name **S27E330H**

Synchronization	Horizontal Frequency	30 – 81 kHz
	Vertical Frequency	56 – 75 Hz
Resolution	Optimum Resolution	1920 x 1080 @ 60 Hz
	Maximum Resolution	1920 x 1080 @ 60 Hz

If a signal that belongs to the following standard signal modes is transmitted from your PC, the screen will automatically be adjusted. If the signal transmitted from the PC does not belong to the standard signal modes, the screen may be blank even though the power LED turns on. In such a case, change the settings according to the following table by referring to the graphics card user manual.

Resolution	Horizontal Frequency (kHz)	Vertical Frequency (Hz)	Pixel Clock (MHz)	Sync Polarity (H/V)
IBM, 720 x 400	31.469	70.087	28.322	-/+
MAC, 640 x 480	35.000	66.667	30.240	-/-
MAC, 832 x 624	49.726	74.551	57.284	-/-
MAC, 1152 x 870	68.681	75.062	100.000	-/-
VESA DMT, 640 x 480	31.469	59.940	25.175	-/-
VESA DMT, 640 x 480	37.861	72.809	31.500	-/-
VESA DMT, 640 x 480	37.500	75.000	31.500	-/-
VESA DMT, 800 x 600	35.156	56.250	36.000	+/+
VESA DMT, 800 x 600	37.879	60.317	40.000	+/+
VESA DMT, 800 x 600	48.077	72.188	50.000	+/+
VESA DMT, 800 x 600	46.875	75.000	49.500	+/+
VESA DMT, 1024 x 768	48.363	60.004	65.000	-/-
VESA DMT, 1024 x 768	56.476	70.069	75.000	-/-
VESA DMT, 1024 x 768	60.023	75.029	78.750	+/+
VESA DMT, 1152 x 864	67.500	75.000	108.000	+/+
VESA DMT, 1280 x 720	45.000	60.000	74.250	+/+
VESA DMT, 1280 x 800	49.702	59.810	83.500	-/+
VESA DMT, 1280 x 1024	63.981	60.020	108.000	+/+
VESA DMT, 1280 x 1024	79.976	75.025	135.000	+/+
VESA DMT, 1440 x 900	55.935	59.887	106.500	-/+

Resolution	Horizontal Frequency (kHz)	Vertical Frequency (Hz)	Pixel Clock (MHz)	Sync Polarity (H/V)
VESA DMT, 1600 x 900 RB	60.000	60.000	108.000	+/+
VESA DMT, 1680 x 1050	65.290	59.954	146.250	-/+
VESA DMT, 1920 x 1080	67.500	60.000	148.500	+/+

Horizontal Frequency

The time required to scan a single line from the left to the right side of the screen is called a horizontal cycle. The reciprocal number of a horizontal cycle is called horizontal frequency. Horizontal frequency is measured in kHz.

Vertical Frequency

Repeating the same picture dozens of times per second allows you to view natural pictures. The repeat frequency is called "vertical frequency" or "refresh rate" and is indicated in Hz.

This product can be set to only one resolution for each screen size to obtain the optimum picture quality due to the nature of the panel. Using a resolution other than the specified resolution may degrade the picture quality. To avoid this, it is recommended that you select the optimum resolution specified for your product.

Check the frequency when you exchange a CDT monitor (connected to a PC) for an LCD monitor. If the LCD monitor does not support 85 Hz, change the vertical frequency to 60 Hz using the CDT monitor before you exchange it with the LCD monitor.

Chapter 11

Appendix

Responsibility for the Pay Service (Cost to Customers)

— When the service is requested, in spite of in warranty, we may charge you for a visit from a service technician in the following cases.

Not a product defect

Cleaning of the product, Adjustment, Explanation, Re-installation and etc.

- If a service technician gives instructions on how to use product or simply adjusts options without disassembling product.
- If a defect is caused by external environmental factors (Internet, Antenna, Wired Signal, etc.)
- If a product is reinstalled or devices are connected additionally after installing the purchased product for the first time.
- If a product is reinstalled to move to a different spot or to move to a different house.
- If customer requests instructions on how to use because of another company's product.
- If customer requests instructions on how to use the network or another company's Program.
- If customer requests software installation and setup for the product.
- If a service technician removes/cleans dusts or foreign materials inside of the product.
- If customer requests an installation additionally after purchasing a product through home-shopping or online.

A Product damage caused by customer's fault

Product damage caused by customer's mishandling or wrong repair

If a product damage is caused by;

- External impact or drop.
- Use of supplies or separately sold product unspecified by Samsung.
- Repair from a person besides an engineer of outsourcing service company or partner of Samsung Electronics Co., Ltd.
- Remodeling or repairing the product by customer.
- Using it with incorrect voltage or non-authorized electrical connections.
- Not following the "cautions" in User Manual.

Others

- If product fails by natural disaster. (lightning, fire, earthquake, flood damage, etc)
- If consumable components are all used up. (Battery, Toner, Fluorescent lights, Head, Vibrator, Lamp, Filter, Ribbon, etc.)

— If customer requests a service in case the product has no defect, service fee may be charged. So please read User Manual first.