

SyncMaster

SERIES  TB300

SERIES  TB350

LED TV MONITOR
(MFM TV)
user manual

Thank you for purchasing this Samsung product.
To receive more complete service, please register
your product at
www.samsung.com/register



Figures and illustrations in this User Manual are provided for reference only and may differ from actual product appearance. Product design and specifications may be changed without notice.

Digital LED display notice

1. Functionalities related to Digital TV (DVB) are only available in countries/areas where DVB-T (MPEG2 and MPEG4 AVC) digital terrestrial signals are broadcasted or where you are able to access to a compatible DVB-C (MPEG2 and MPEG4 AAC) cable-TV service. Please check with your local dealer the possibility to receive DVB-T or DVB-C signal.
2. DVB-T is the DVB European consortium standard for the broadcast transmission of digital terrestrial television and DVB-C is that for the broadcast transmission of digital LED display over cable.
3. Although this LED display set meets the latest DVB-T and DVB-C standards, as of [August, 2008], the compatibility with future DVB-T digital terrestrial and DVB-C digital cable broadcasts cannot be guaranteed.
4. Depending on the countries/areas where this LED display set is used some cable-TV providers may charge an additional fee for such a service and you may be required to agree to terms and conditions of their business.
5. Some Digital LED display functions might be unavailable in some countries or regions and DVB-C might not work correctly with some cable service providers.
6. For more information, please contact your local Samsung customer care centre.
 - ✎ The reception quality of LED display may be affected due to differences in broadcasting method between the countries. Please check the LED display performance in the local SAMSUNG Authorized Dealer, or the Samsung Call Centre whether it can be improved by reconfiguring LED display setting or not.

Still image warning

Avoid displaying still images (like jpeg picture files) or still image element (like LED display programme logo, panorama or 4:3 image format, stock or news bar at screen bottom etc.) on the screen. Constant displaying of still picture can cause ghosting of screen, which will affect image quality. To reduce risk of this effect, please follow below recommendations:

- Avoid displaying the same LED display channel for long periods.
- Always try to display any image on full screen, use LED display set picture format menu for best possible match.
- Reduce brightness and contrast values to minimum required to achieve desired picture quality, exceeded values may speed up the burnout process.
- Frequently use all LED display features designed to reduce image retention and screen burnout, refer to proper user manual section for details.

Securing the Installation Space

Keep the required distances between the product and other objects (e.g. walls) to ensure proper ventilation. Failing to do so may result in fire or a problem with the product due to an increase in the internal temperature of the product.

- ✎ The actual appearance of the LED display may differ from the images in this manual, depending on the model.
- ✎ Be careful when you touch the LED display. Some parts can be somewhat hot.

Installation with a stand.

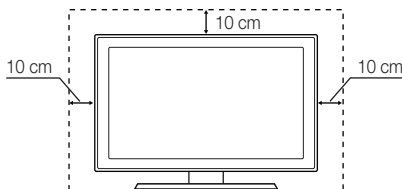

Installation with a wall-mount.

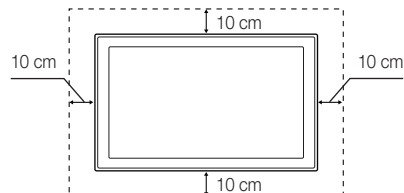

- An administration fee may be charged if either
 - (a) an engineer is called out at your request and there is no defect in the product (i.e. where you have failed to read this user manual).
 - (b) you bring the unit to a repair centre and there is no defect in the product (i.e. where you have failed to read this user manual).
- The amount of such administration charge will be advised to you before any work or home visit is carried out.

Contents

Getting Started

4

- 4 Safety Precautions
- 11 Accessories
- 12 Viewing the Control Panel
- 13 Viewing the Remote Control

Connections

14

- 14 Connecting to an Antenna
- 14 Setup (Initial Setup)
- 15 Connecting to an AV Device
- 16 Connecting to a COMMON INTERFACE slot
- 17 Connecting to a Audio device and PC
- 19 Changing the Input Source

Basic Features

19

- 19 How to Navigate Menu
- 20 Using the INFO button (Now & Next guide)
- 20 Using the Channel Menu
- 22 Channel Menu
- 23 Picture Menu
- 25 Sound Menu
- 27 System Menu
- 30 Support Menu

Advanced Features

31

- 31 Using the Media Play

Other Information

38

- 38 Analogue Channel Teletext Feature
- 39 Attaching a Wall Mount/Desktop Stand
- 40 Anti-theft Kensington Lock
- 41 Troubleshooting
- 45 Specifications

Check the Symbol!



This function can be used by pressing the TOOLS  button on the remote control.





Note
Indicates additional information.



Getting Started

Safety Precautions

Icons used for safety precautions

	WARNING	Failing to follow the precautions marked with this sign may result in a serious injury or even a fatality.
---	----------------	--

	CAUTION	Failing to follow the precautions marked with this sign may result in a personal injury or property damage.
---	----------------	---

-  Do not perform.
-  Must be followed.

CAUTION

RISK OF ELECTRIC SHOCK DO NOT OPEN

CAUTION: TO REDUCE THE RISK OF ELECTRIC SHOCK, DO NOT REMOVE COVER (OR BACK). THERE ARE NO USER SERVICEABLE PARTS INSIDE. REFER ALL SERVICING TO QUALIFIED PERSONNEL.

 This symbol indicates that high voltage is present inside. It is dangerous to make any kind of contact with any internal part of this product.

 This symbol alerts you that important literature concerning operation and maintenance has been included with this product.

Power Related

 The following images are for your reference and may differ depending on models and countries.

Warning

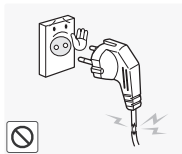

Avoid using a damaged power cord or plug or a loose power outlet.

- Otherwise, it may result in electric shock or fire.



Avoid connecting multiple electric appliances to a single wall outlet.

- Otherwise, it may result in fire due to overheating of the wall outlet.

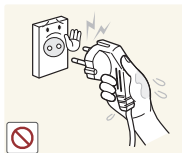

Avoid plugging in or unplugging the power supply with wet hands.

- Otherwise, it may result in electric shock.

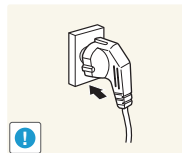

Plug the power plug in firmly.

- Otherwise, it may result in fire.

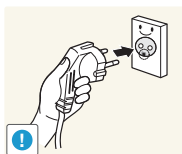

Make sure to connect the power cord to a grounded wall outlet (for insulation class 1 equipment only).

- Otherwise, it may result in electric shock or injury.

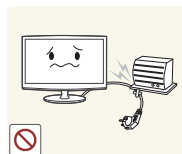

Avoid bending or twisting the power cord excessively and avoid placing heavy objects on the cord.

- Otherwise, it may result in electric shock or fire due to a damaged power cord.

Getting Started



Keep the power cord and the product away from a heater.

- Otherwise, it may result in electric shock or fire.

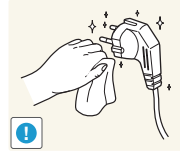

If the pins of the power plug or the wall outlet are covered in dust, clean it using a dry cloth.

- Otherwise, it may result in fire.

⚠ Caution



Avoid unplugging the power plug while the product is operating.

- Otherwise, it may damage the product due to electric shock.

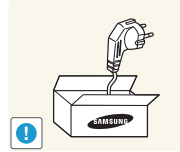

Make sure to use only the power cord supplied by our company. In addition, do not use the power cord of another electric appliance.

- Otherwise, it may result in electric shock or fire.

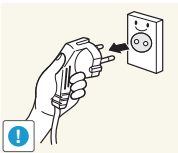

When unplugging the power plug from the wall outlet, make sure to hold it by the plug and not by the cord.

- Otherwise, it may result in electric shock or fire.

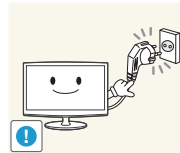

Connect the power plug to a wall outlet that can be easily reached.

- When a problem occurs with the product, you must unplug the power plug to cut the power off completely. You cannot cut the power off completely using only the power button on the product.

Installation Related

⚠ Warning



Avoid placing burning candles, mosquito repellent or cigarettes on the product.

- Otherwise, it may result in fire.

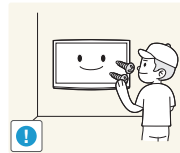

Ask an installation engineer or relevant company to install the product onto the wall.

- Otherwise, it may result in injury.
- Make sure to use the specified wall mount.



Avoid installing the product in a badly-ventilated location such as inside a bookshelf or closet.

- Otherwise, it may result in fire due to internal over-heating.

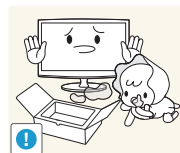

Keep the plastic bags used to pack the product away from children.

- If children place the plastic bags over their heads, they may suffocate.



Avoid installing the product in a location that is unstable or exposed to excessive vibration such as on an unstable or slanted shelf.

- The product may fall and this may result in damage to the product or injury.
- If you use the product in a location exposed to excessive vibrations, it may result in a problem with the product or fire.

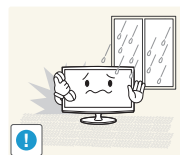

Avoid installing the product in a location exposed to dust, moisture (sauna), oil, smoke or water (rain drops) and installing it within a vehicle.

- This may result in electric shock or fire.

Getting Started

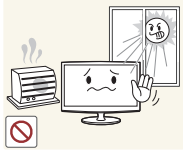

Avoid installing the product in a location exposed to direct sunlight and installing the product near a heat source such as a fireplace or heater.

- This may shorten the product life cycle or cause fire.

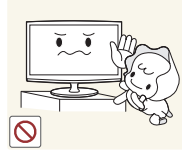

Avoid installing the product where children may reach it.

- If a child touches the product, the product may fall and this may result in injury.
- Since the front part is heavier, install the product on a flat and stable surface.



Bend the outdoor antenna cable downwards at the location where it comes in the house so that rainwater does not flow in.

- If rainwater enters the product, it may result in electric shock or fire.

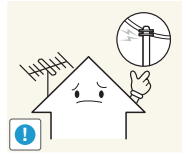

Install the antenna far away from any high voltage cables.

- If the antenna touches or falls onto a high voltage cable, it may result in electric shock or fire.

Caution

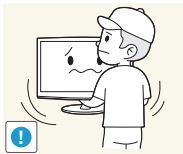

Do not let the product drop while moving it.

- This may result in a problem with the product or injury.

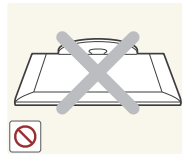

Do not place the product face down on the floor.

- This may damage the panel of the product.

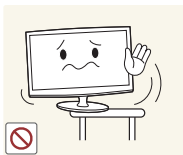

When installing the product on a console or shelf, make sure that the front of the product does not protrude out of the console or shelf.

- Otherwise, this may cause the product to fall off and result in a malfunction or injury.
- Make sure to use a cabinet or shelf suitable to the size of the product.

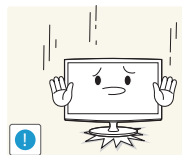

When putting the product down, handle it gently.

- Otherwise, it may result in a problem with the product or injury.



If the product is installed in a location where the operating conditions vary considerably, a serious quality problem may occur due to the surrounding environment. In this case, install the product only after consulting one of our service engineers about the matter.

- Places exposed to microscopic dust, chemicals, too high or low temperature, high humidity, airports or stations where the product is continuously used.

Getting Started

Cleaning Related

Warning

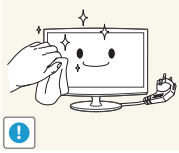

Before cleaning the product, unplug the power cord.

- Otherwise, it may result in electric shock or fire.



When cleaning the product, do not spray water directly over the product parts.

- Make sure that water does not enter the product.
- Otherwise, it may result in fire, electric shock or a problem with the product.

Caution



Avoid spraying cleansing agent directly onto the product.

- This may result in discoloration or cracking of the exterior of the product or the panel coming off.

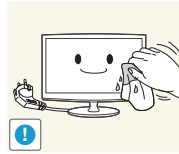

When cleaning the product, disconnect the power cord and clean the product with the supplied cleaning cloth.

- Avoid using chemicals such as wax, benzene, alcohol, thinner, mosquitorepellent, fragrance, lubrication or cleansing agent when cleaning the product.
This may result in the exterior being deformed or the print being removed.

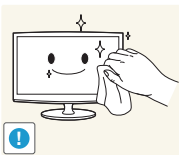

If you can't get the product clean with just the supplied cloth, use a soft, damp cloth with a "monitor-exclusive cleansing agent" and wipe the product with it.

- If no monitor-exclusive cleansing agent is available, dilute a cleansing agent with water at a ratio of 1:10 before cleaning the product.



Since the exterior of the product is easily scratched, be sure to use the supplied cleansing cloth.

Usage Related

Warning



Since a high voltage runs through the product, never disassemble, repair or modify the product yourself.

- Otherwise, it may result in fire or electric shock.
- If the product needs to be fixed, contact a service centre.

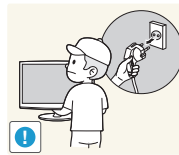

To move the product, turn the power off and unplug the power cord, the antenna cable and any other wires connected to the product.

- Otherwise, it may result in electric shock or fire due to the damaged power cord.

Getting Started

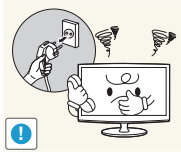

If the product generates a strange noise, a burning smell, or smoke, unplug the power plug immediately and contact a service centre.

- Otherwise, it may result in electric shock or fire.

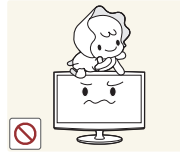

Avoid letting children hang or climb onto the product.

- Otherwise, it may result in the product falling and this may result in injury or death.



If you drop the product or the case is damaged, turn the power off and unplug the power cord. Contact a service centre.

- Otherwise, it may result in fire or electric shock.



Avoid placing objects such as toys and cookies on top of the product.

- If a child hangs over the product to grab an object, the object or the product may fall and this may result in injury or even death.

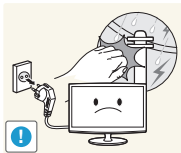

When thunder or lightning occurs, unplug the power cord and under no circumstance touch the antenna cable as this is dangerous.

- Otherwise, it may result in electric shock or fire.



Avoid dropping an object over the product or cause impact to the product.

- Otherwise, it may result in electric shock or fire.

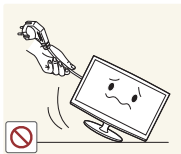

Avoid moving the product by pulling the power cord or antenna cable.

- Otherwise, it may result in electric shock, fire or a problem with the product due to damage to the cable.

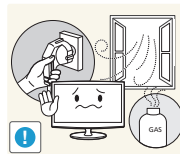

When a gas leak occurs, do not touch the product or the power plug and ventilate immediately.

- A spark may result in an explosion or fire.
- During a thunder or lightning storm, do not touch the power cord or antenna cable.

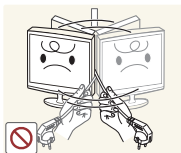

Avoid lifting up or moving the product by holding only the power cord or signal cable.

- Otherwise, it may result in electric shock, fire or a problem with the product due to damage to the cable.

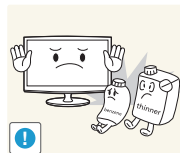

Avoid using or placing inflammable spray or objects near the product.

- This may result in an explosion or fire.



Take care not to block the vent by a table cloth or curtain.

- Otherwise, it may result in fire due to internal overheating.



Avoid inserting metal objects such as a chopsticks, coins or hairpins, or inflammable objects into the product (the vents, ports, etc).

- If water or substances enters the product, turn the power off, unplug the power cord and contact a service centre.
- Otherwise, it may result in a problem with the product, electric shock or fire.

Getting Started



Avoid placing a liquid container such as a vase, flowerpot, beverage, cosmetics or drugs, or a metal object over the product.

- If water or substances enter the product, turn the power off, unplug the power cord and contact a service centre.
- Otherwise, it may result in a problem with the product, electric shock or fire.



Do not press down hard on the product. The product may become deformed or damaged.

Caution



Displaying a still image for a long time may create a persistent image or stain on the screen.

- If you do not use the product for a long time, use the power-saving mode or set the screensaver to the moving picture mode.

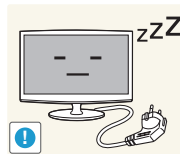

When not using the product for a long time such as leaving your home, unplug the power cord from the wall outlet.

- Otherwise, it may cause dust accumulation and result in fire caused by overheating or short circuit or result in an electric shock.



Set the appropriate resolution and frequency for the product.

- Otherwise, it may result in eye strain.



Avoid turning the product upside down or move the product holding only the stand.

- This may cause the product to fall, resulting in damage to the product or injury.

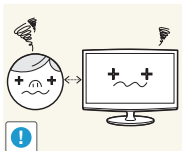

Watching the product from too close a distance continuously may damage your eyesight.



Avoid using a humidifier or cooker near the product.

- Otherwise, it may result in electric shock or fire.

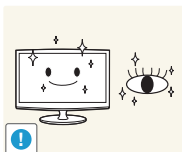

It is important to give your eyes some rest (5 minutes every hour) when viewing the product screen for long periods of time.

- This will alleviate any eye strain.

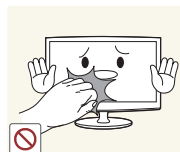

Since the display panel is hot after using it for a long time, do not touch the product.

Getting Started

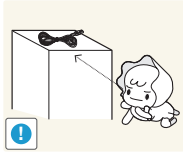

Keep the small accessories in a location out of the reach of children.

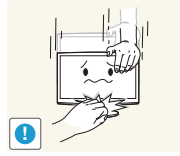

Take care when adjusting the angle of the product or the height of the stand.

- If your hand or finger is caught, you may be injured.
- If the product is tilted excessively, the product may fall and this may result in injury.



Avoid placing a heavy object over the product.

- Otherwise, it may result in a problem with the product or injury.



When using headphones or earphones, do not turn the volume too high.

- Having the sound too loud may damage your hearing.

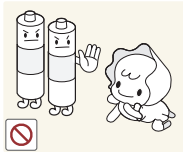

Be careful that children do not place the batteries in their mouths when removed from the remote control. Place the battery in a location that children or infants cannot reach.

- If children have had the battery in their mouths, consult your doctor immediately.

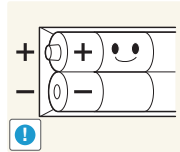

When replacing the batteries, insert them with right polarity (+, -).

- Otherwise, the battery may become damaged or it may cause fire, personal injury or damage due to leakage of the internal liquid.

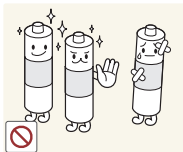

Use only specified standard batteries. Do not use new and used batteries together.

- This may cause a battery to break or leak and may cause fire, injury, or contamination (damage).

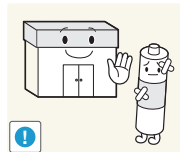

The batteries (and rechargeable batteries) are not ordinary refuse and must be returned for recycling purposes. The customer is responsible for returning the used or rechargeable batteries for recycling.

- The customer can return used or rechargeable batteries to a nearby public recycling centre or to a store selling the same type of the battery or rechargeable battery.

Getting Started

Accessories

- ✎ Please make sure the following items are included with your LED display. If any items are missing, contact your dealer.
- ✎ The items' colours and shapes may vary depending on the models.
- ✎ Cables not included in the package contents can be purchased separately.
- ✎ Check that there is no accessory hidden behind packing materials when you open the box.

⚠ CAUTION: INSERT SECURELY LEST SHOULD BE DETACHED IN SET

- User Manual
- Remote Control & Batteries (AAA x 2)
- Warranty Card / Safety Guide (Not available in some locations)
- Quick Setup Guide
- Cleaning Cloth
- Power Cord

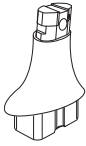

• Stand Connector



• Stand Base

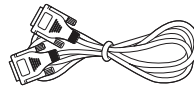

• D-Sub Cable



• Stereo Cable

Input Cables (Sold Separately)

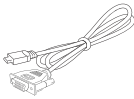

• HDMI to DVI Cable

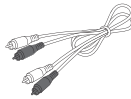

• Audio Cable

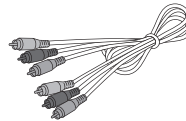

• Component Cable

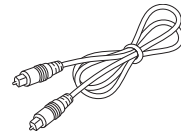

• Optical Cable





• HDMI Cable

Getting Started

Viewing the Control Panel

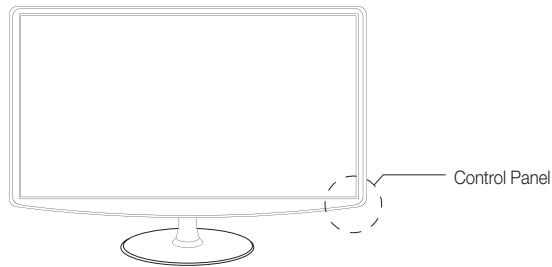
 The product colour and shape may vary depending on the model.



SOURCE 	Toggles between all the available input sources. In the on-screen menu, use this button as you would use the ENTER  button on the remote control.
MENU	Displays an on-screen menu, the OSD (on screen display) of your LED display's features.
- ▲ +	Adjusts the volume. In the OSD, use the - ▲ + buttons as you would use the ◀ and ▶ buttons on the remote control.
▼ CH ▲	Changes the channels. In the OSD, use the ▼ CH ▲ buttons as you would use the ▲ and ▼ buttons on the remote control.
⏻ (Power)	Turns the LED display on or off.
Power Indicator	Blinks and turns off when the power is on and lights up in standby mode.
Remote control sensor	Aim the remote control towards this spot on the LED display.

Standby mode

Do not leave your LED display in standby mode for long periods of time (when you are away on a holiday, for example). A small amount of electric power is still consumed even when the power button is turned off. It is best to unplug the power cord.

Getting Started

Viewing the Remote Control

 This is a special remote control for the visually impaired and has Braille points on the Channel and Number buttons.

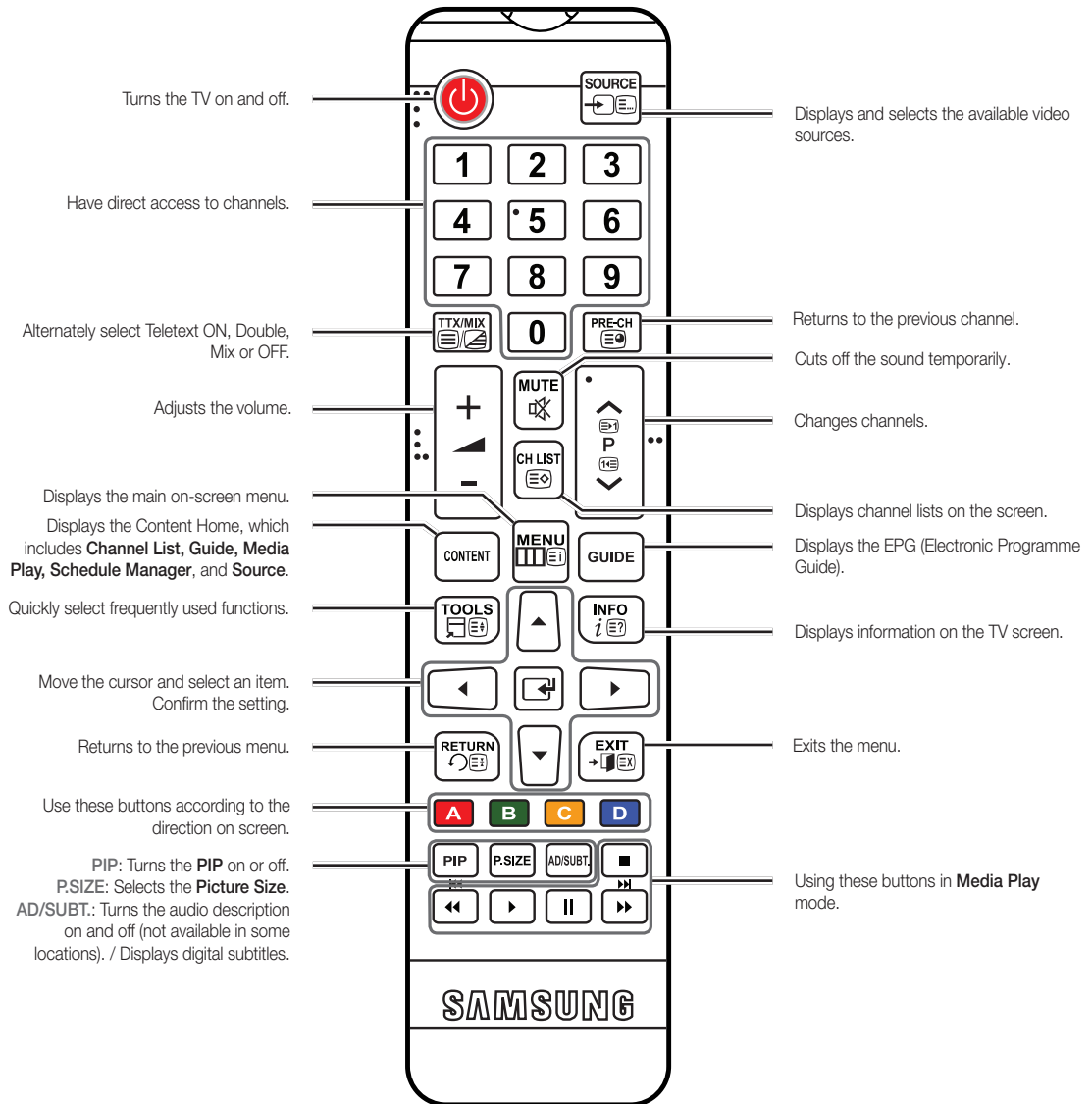

Installing batteries (Battery size: AAA)

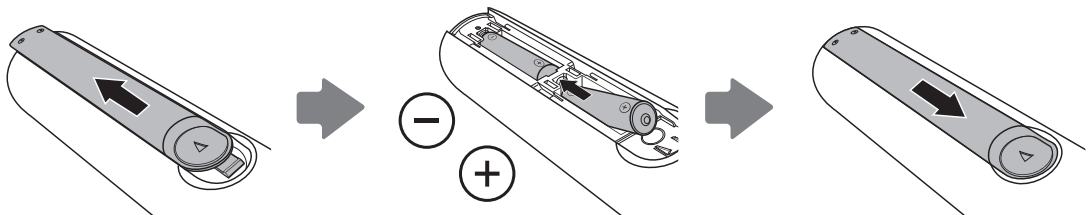

Connections

Connecting to an Antenna

When the LED display is initially powered on, basic settings proceed automatically.



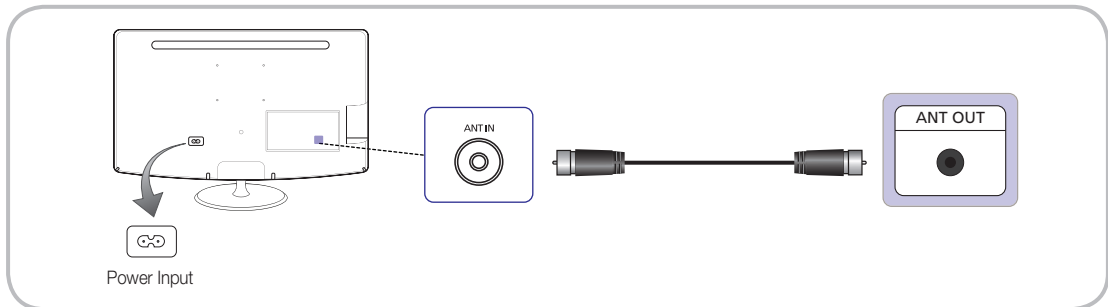







 **Preset:** Connecting the mains and antenna.



Setup (Initial Setup)

When the LED display is initially powered on, a sequence of on-screen prompts will assist in configuring basic settings. Press the **POWER**  button. **Setup** is available only when the Input **Source** is set to **TV**.

 Before turning on the LED display, make sure the antenna cable is connected.

1	Selecting a menu language	Press the ▲ or ▼ button to select a menu language. Press ENTER  button twice when done.	
2	Selecting Store Demo or Home Use	Press the ▲ or ▼ button, then press the ENTER  button. <ul style="list-style-type: none"> • Select the Home Use mode. Store Demo Mode is for retail environments. • To return the unit's settings from Store Demo to Home Use (standard): Press the volume button on the LED display. When you see the volume OSD, press and hold MENU for 5 sec. • Store Demo is only for shop display. If you select it, several functions are not able to use. Please select Home Use when you watch at home. 	
3	Selecting an area	Press the ENTER  button. Select the appropriate area by pressing the ▲ or ▼ button. Press the ENTER  button to confirm your choice.	
4	Auto Tuning	Press the ▲ or ▼ button to select correct option, and then press ENTER  button twice. Let's find and store channels on your TV. Do you need to search for channels? <ul style="list-style-type: none"> • Yes, I need to. All the channels available will be found and stored on your TV. (Auto Tuning necessary) • No, I don't need to. My set-top box provides all the channels that are available, so I don't need to search for channels. <ul style="list-style-type: none">  You can complete Setup by selecting it. • Air / Cable: Select the antenna source to memorise. Digital & Analogue / Digital / Analogue: Select the channel source to memorise. <ul style="list-style-type: none">  You can check more details on page22. 	
5	Setting the Clock Mode	Set the Clock Mode automatically or manually. <ul style="list-style-type: none"> • Auto: Select the time zone (depending on the country) where you are located. • Manual: Allows you to manually set the current date and time. <ul style="list-style-type: none">  If the customer chooses "No, I don't need to." in step 4, the clock just can be set manually. 	
6	Complete	Press the ENTER  button.	

If You Want to Reset This Feature...

Select **System - Setup** (Initial Setup). Enter your 4 digit PIN number. The default PIN number is "0-0-0-0". If you want to change the PIN number, use the **Change PIN** function.

You should do **Setup** (**MENU** → **System**) again at home although you did in shop.

 If you forget the PIN code, press the remote control buttons in the following sequence in Standby mode, which resets the PIN to "0-0-0-0": **POWER** (off) → **MUTE** → **8** → **2** → **4** → **POWER** (on).

Connections

Connecting to an AV Device

Using an HDMI or an HDMI to DVI cable (up to 1080p)

Available devices: DVD, Blu-ray player, HD cable box, HD STB (Set-Top-Box) satellite receiver, VCR

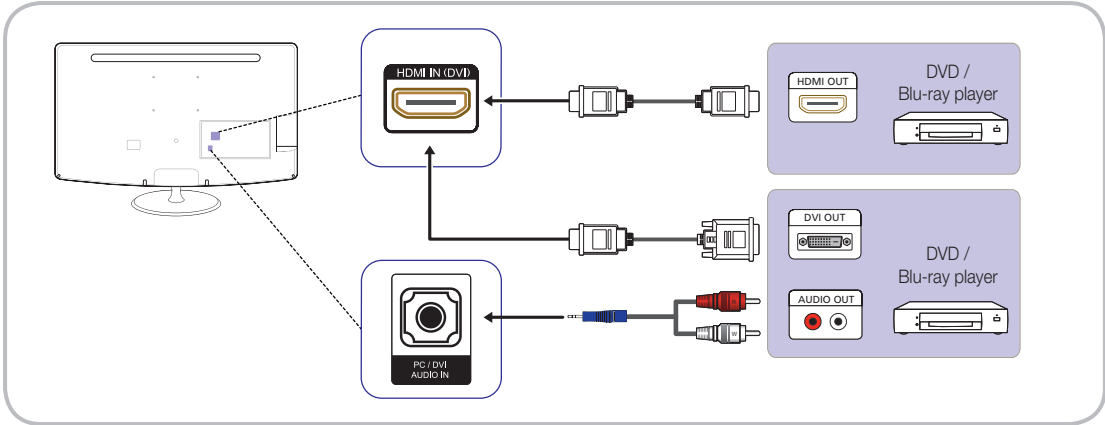

HDMI IN(DVI) / PC/DVI AUDIO IN

- If an HDMI to DVI cable is connected to the HDMI IN(DVI) port, the audio does not work.
- The picture may not display normally (if at all) or the audio may not work if an external device that uses an older version of HDMI mode is connected to the LED display. If such a problem occurs, ask the manufacturer of the external device about the HDMI version and, if out of date, request an upgrade.
- Be sure to purchase a certified HDMI cable. Otherwise, the picture may not display or a connection error may occur.
- A basic high-speed HDMI cable or one with ethernet is recommended. This product does not support the ethernet function via HDMI.

Using a Scart Cable

Available devices: DVD, VCR

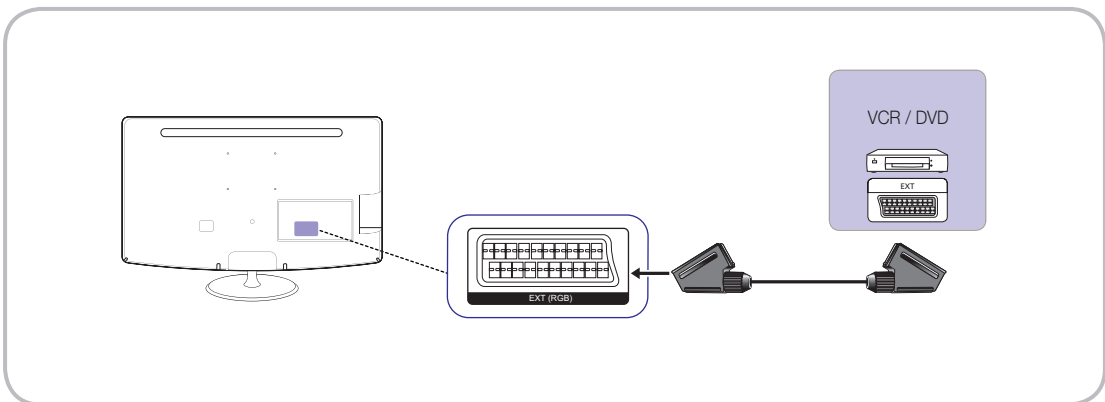

 In **Ext.** mode, DTV Out supports MPEG SD Video and Audio only.

Connections

Using a Component (up to 1080p) or Audio/Video (480i only) Cable

Available devices: DVD, Blu-ray player, cable box, STB satellite receiver, VCR

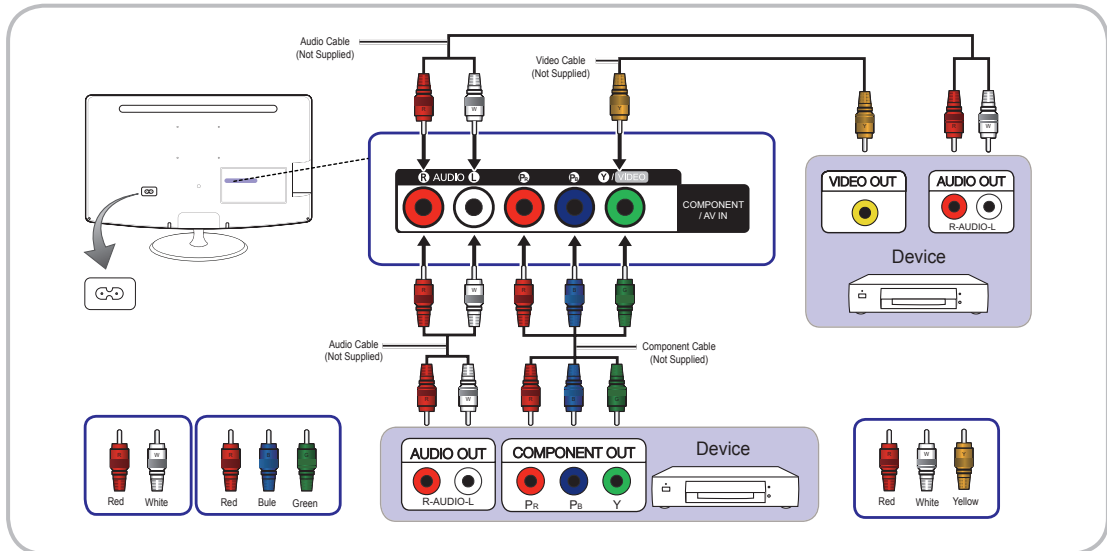

- 🔗 When connecting to AV IN, the colour of the AV IN [Y/VIDEO] jack (green) will not match the video cable (yellow).
- 🔗 For better picture quality, the Component connection is recommended over the A/V connection.

Connecting to a COMMON INTERFACE slot

(Just for Europe, Turkey, Algeria, South Africa, and CIS area)

Using the "CI or CI+ CARD"

To watch paid channels, the "CI or CI+ CARD" must be inserted.

- If you don't insert the "CI or CI+ CARD," some channels will display the message "Scrambled Signal".
- The pairing information containing a telephone number, the "CI or CI+ CARD" ID the Host ID and other information will be displayed in about 2~3 minutes. If an error message is displayed, please contact your service provider.
- When the configuration of channel information has finished, the message "Updating Completed" is displayed, indicating the channel list is updated.

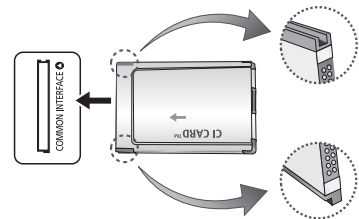

NOTE

- You must obtain a "CI or CI+ CARD" from a local cable service provider.
- When removing the "CI or CI+ CARD", carefully pull it out with your hands since dropping the "CI or CI+ CARD" may cause damage to it.
- Insert the "CI or CI+ CARD" in the direction marked on the card.
- The location of the COMMON INTERFACE slot may be different depending on the model.
- "CI or CI+ CARD" is not supported in some countries and regions; check with your authorized dealer.
- If you have any problems, please contact a service provider.
- Insert the "CI or CI+ CARD" that supports the current antenna settings. The screen will be distorted or will not be seen.

Connections

Connecting to a Audio device and PC

Using an Optical (Digital) or a Headphone Connection

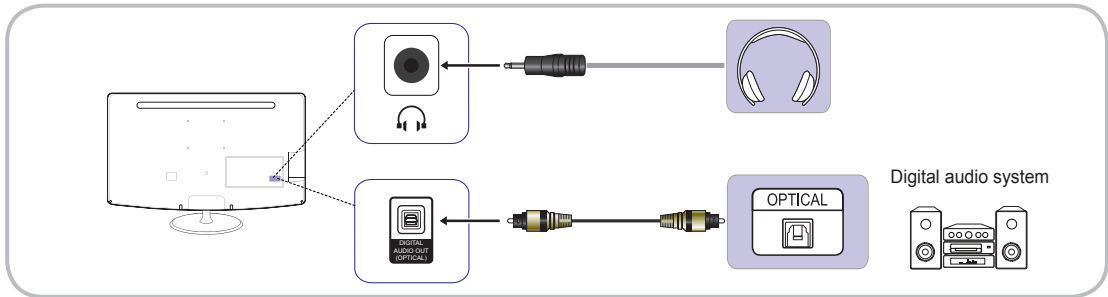

TB300 series have not headphone and Optical interface.

DIGITAL AUDIO OUT (OPTICAL)

- When a Digital Audio System is connected to the **DIGITAL AUDIO OUT (OPTICAL)** jack, decrease the volume of both the LED display and the system.
- 5.1 CH (channel) audio is available when the LED display is connected to an external device supporting 5.1 CH.
- When the receiver (home theatre) is set to on, you can hear sound output from the TV's optical jack. When the TV is receiving a DTV signal, the TV will send 5.1 CH sound to the home theatre receiver. When the source is a digital component such as a DVD / Blu-ray player / cable box / STB (Set-Top-Box) satellite receiver and is connected to the TV via HDMI, only 2 CH audio will be heard from the home theatre receiver. If you want to hear 5.1 CH audio, connect the digital audio out jack from your DVD / Blu-ray player / cable box / STB satellite receiver directly to an amplifier or home theatre.

Headphones : You can connect your headphones to the headphones output on your set. While the headphones are connected, the sound from the built-in speakers will be disabled.

- Sound function may be restricted when connecting headphones to the LED display.
- Headphone volume and LED display volume are adjusted separately.

Using an HDMI cable or an HDMI to DVI cable or a D-sub cable

Connecting through the HDMI cable may not be supported depending on the PC.

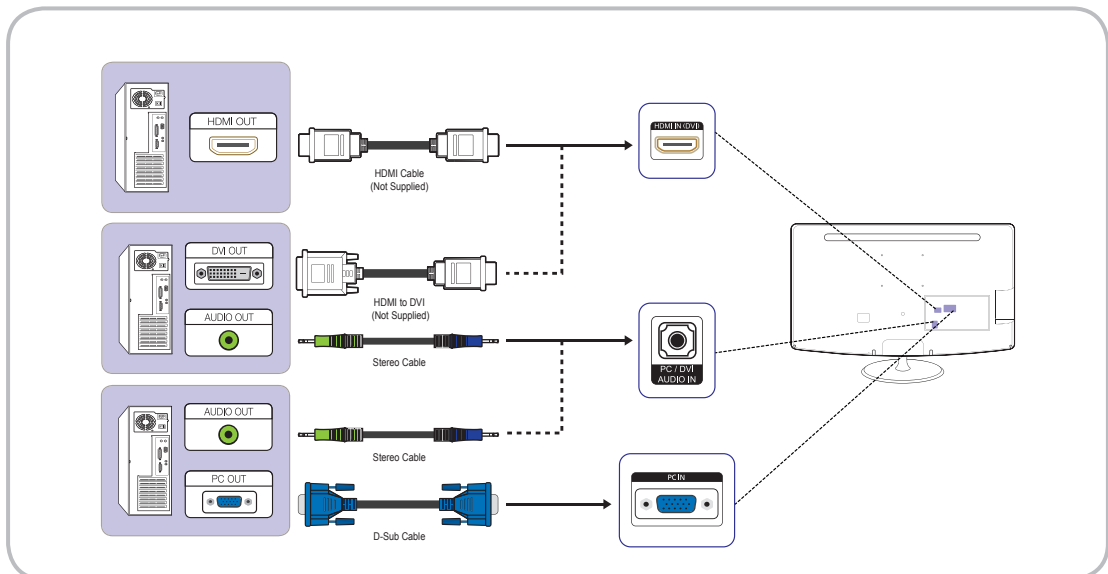

Connections

Display Modes (D-Sub and HDMI/DVI Input)

Optimal resolution : 1366 x 768 pixels (T19B300 model only)

Display Mode			Horizontal Frequency (kHz)	Vertical Frequency (Hz)	Pixel Clock (MHz)	Sync Polarity (H/V)
Mode	Resolution					
IBM	720 x 400	70Hz	31.469	70.087	28.322	-/+
VESA DMT	640 x 480	60Hz	31.469	59.940	25.175	-/-
MAC	640 x 480	67Hz	35.000	66.667	30.240	-/-
VESA DMT	640 x 480	72Hz	37.861	72.809	31.500	-/-
VESA DMT	640 x 480	75Hz	37.500	75.000	31.500	-/-
VESA DMT	800 x 600	60Hz	37.879	60.317	40.000	+/+
VESA DMT	800 x 600	72Hz	48.077	72.188	50.000	+/+
VESA DMT	800 x 600	75Hz	46.875	75.000	49.500	+/+
MAC	832 x 624	75Hz	49.726	74.551	57.284	-/-
VESA DMT	1024 x 768	60Hz	48.363	60.004	65.000	-/-
VESA DMT	1024 x 768	70Hz	56.476	70.069	75.000	-/-
VESA DMT	1024 x 768	75Hz	60.023	75.029	78.750	+/+
VESA DMT	1280 x 720	60Hz	45.000	60.000	74.250	+/+
VESA DMT	1366 x 768	60Hz	47.712	59.790	85.500	+/+

Optimal resolution : 1920 x 1080 pixels

Display Mode			Horizontal Frequency (kHz)	Vertical Frequency(Hz)	Pixel Clock (MHz)	Sync Polarity (H/V)
Mode	Resolution					
IBM	720 x 400	70Hz	31.469	70.087	28.322	-/+
VESA DMT	640 x 480	60Hz	31.469	59.940	25.175	-/-
MAC	640 x 480	67Hz	35.000	66.667	30.240	-/-
VESA DMT	640 x 480	72Hz	37.861	72.809	31.500	-/-
VESA DMT	640 x 480	75Hz	37.500	75.000	31.500	-/-
VESA DMT	800 x 600	60Hz	37.879	60.317	40.000	+/+
VESA DMT	800 x 600	72Hz	48.077	72.188	50.000	+/+
VESA DMT	800 x 600	75Hz	46.875	75.000	49.500	+/+
MAC	832 x 624	75Hz	49.726	74.551	57.284	-/-
VESA DMT	1024 x 768	60Hz	48.363	60.004	65.000	-/-
VESA DMT	1024 x 768	70Hz	56.476	70.069	75.000	-/-
VESA DMT	1024 x 768	75Hz	60.023	75.029	78.750	+/+
VESA DMT	1152 x 864	75Hz	67.500	75.000	108.000	+/+
MAC	1152 x 870	75Hz	68.681	75.062	100.000	-/-
VESA DMT	1280 x 720	60Hz	45.000	60.000	74.250	+/+
VESA DMT	1280 x 800	60Hz	49.702	59.810	83.500	-/+
VESA DMT	1280 x 1024	60Hz	63.981	60.020	108.000	+/+
VESA DMT	1280 x 1024	75Hz	79.976	75.025	135.000	+/+
VESA DMT	1366 x 768	60Hz	47.712	59.790	85.500	+/+
VESA DMT	1440 x 900	60Hz	55.935	59.887	106.500	-/+
VESA DMT	1600 x 900RB	60Hz	60.000	60.000	108.000	+/+
VESA DMT	1680 x 1050	60Hz	65.290	59.954	146.250	-/+
VESA DMT	1920 x 1080	60Hz	67.500	60.000	148.500	+/+

NOTE

- The interlace mode is not supported.
- The set might operate abnormally if a non-standard video format is selected.
- Separate and Composite modes are supported. SOG(Sync On Green) is not supported.

Connections

Changing the Input Source

Source

SOURCE → Source

Use to select LED display or an external input sources such as a DVD / Blu-ray player / cable box / STB satellite receiver.

■ TV / Ext. / PC / HDMI/DVI / AV / Component

In the **Source**, connected inputs will be highlighted.

TV, PC and Ext. always stay activated.



Edit Name

SOURCE → TOOLS → Edit Name → ENTER

In the **Source**, press the TOOLS button, and then you can set an external input sources name you want.

■ VCR / DVD / Cable STB / Satellite STB / PVR STB / AV Receiver / Game / Camcorder / PC / DVI PC / DVI Devices / TV / IPTV / Blu-ray / HD DVD / DMA: Name the device connected to the input jacks to make your input source selection easier.

When connecting a PC to the HDMI IN (DVI) port with HDMI cable, you should set the LED display to PC mode under **Edit Name**.

When connecting a PC to the HDMI IN (DVI) port with HDMI to DVI cable, you should set the LED display to DVI PC mode under **Edit Name**.

When connecting an AV devices to the HDMI IN (DVI) port with HDMI to DVI cable, you should set the LED display to DVI Devices mode under **Edit Name**.

Information

SOURCE → TOOLS → Information → ENTER

You can see detailed information about the selected external device.

Basic Features

How to Navigate Menus

Before using the LED display, follow the steps below to learn how to navigate the menu and select and adjust different functions.

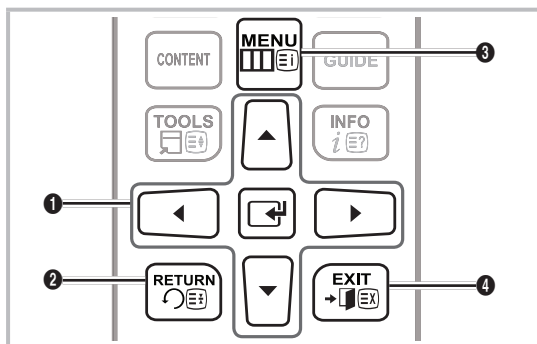

- 1 ENTER / Direction button: Move the cursor and select an item. Confirm the setting.
- 2 RETURN : Returns to the previous menu.
- 3 MENU : Displays the main on-screen menu.
- 4 EXIT : Exits the on-screen menu.

How to Operate the OSD (On Screen Display)

The access step may differ depending on the selected menu.

- 1 MENU The main menu options appear on the screen:
Picture, Sound, Channel, System, Support.
- 2 ▲ / ▼ Select an icon with the ▲ or ▼ button.
- 3 ENTER Press ENTER to access the sub-menu.
- 4 ▲ / ▼ Select the desired submenu with the ▲ or ▼ button.
- 5 ◀ / ▶ Adjust the value of an item with the ◀ or ▶ button. The adjustment in the OSD may differ depending on the selected menu.
- 6 ENTER Press ENTER to complete the configuration.
- 7 EXIT Press EXIT.

Basic Features

Using the INFO button (Now & Next guide)

The display identifies the current channel and the status of certain audio-video settings.

The Now & Next guide shows daily LED display programme information for each channel according to the broadcasting time.



- Scroll ◀ / ▶ to view information for a desired programme while watching the current channel. (Depending on the channels)
- Scroll ▲ / ▼ to view information for other channels. If you want to move to the currently selected channel, press the ENTER [↵] button.

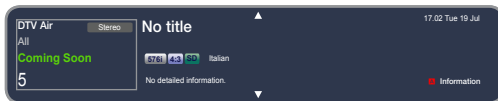

- The displayed image may differ depending on the model.

Using the Channel Menu

Press the CONTENT button to select **Contents Home**, and then select the menu you want to use. Each screen will be displayed.

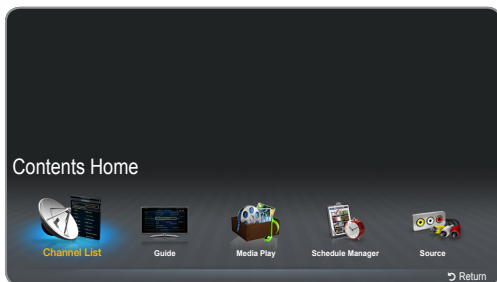

- The displayed image may differ depending on the model.

Guide

CONTENT → Contents Home → Guide → ENTER [↵]

The EPG (Electronic Programme Guide) information is provided by broadcasters. Using programme schedules provided by broadcasters, you can specify programmes you want to watch in advance so that the channel automatically changes to the selected programme channel at the specified time. Programme entries may appear blank or out of date depending on a channel status.



Using Channel View



- The displayed image may differ depending on the model.
- **A** Red (Sche. Mgr) : Displays the **Schedule Manager**.
- **B** Green (-24 Hours): Viewing the list of programmes to be broadcasted before 24 hours.
- **C** Yellow (+24 Hours): Viewing the list of programmes to be broadcasted after 24 hours.
- **D** Blue (Ch. Mode): Select the type of channels you want to display on the **Channel View** window.
- **i** (Information): Displays details of the selected programme.
- **↔** (Page): Move to next or previous page.
- **[↵]** (Watch / Schedule)
 - When selecting the current programme, you can watch the selected programme.
 - When selecting the future programme, you can reserve to watch the selected programme. To cancel the schedule, press the ENTER [↵] button again and select **Cancel Schedule**.

Schedule Manager

CONTENT → Contents Home → Schedule Manager → ENTER [↵]

You can view, modify or delete a channel you have reserved to watch.

Using the Schedule Viewing

You can set a desired channel to be displayed automatically at the intended time. Set the current time first to use this function.

1. Press the ENTER [↵] button to select **Schedule Manager**.
2. Press the TOOLS [⚙] button or **A** button to add programme to schedule manually. The **Schedule Viewing** screen appears.
3. Press the ▲ / ▼ / ◀ / ▶ buttons to set the **Aerial, Channel, Repeat, Date** or **Start Time**.

Basic Features

- **Aerial:** Select the desired antenna source.
- **Channel:** Select the desired channel.
- **Repeat:** Select **Once**, **Manual**, **Sat~Sun**, **Mon~Fri** or **Everyday** to set at your convenience. If you select **Manual**, you can set the day you want.
 - ✎ The ✓ mark indicates the date is selected.
- **Date:** you can set desired date.
 - ✎ It is available when you select **Once** in **Repeat**.
- **Start Time:** You can set start time you want.
 - ✎ On the **Information** screen, you can change or cancel a reserved information.
 - **Cancel Schedule:** Cancel a show you have reserved to watch.
 - **Edit:** Change a show you have reserved to watch.
 - **Return:** Return to the previous screen.

Channel List

CONTENT → Channel List → ENTER

You can view all the channel searched.

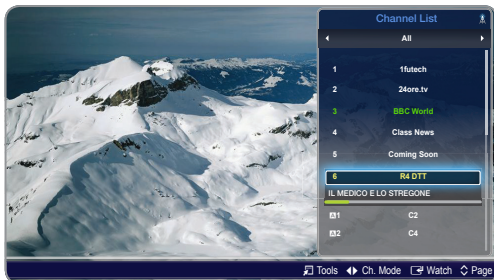

- The displayed image may differ depending on the model.

✎ When you press the CH LIST button on the remote control, **Channel List** screen will be displayed at once.

Using the operation buttons with the **Channel List**.

- **(Tools):** Press Tools button to check the following functions.
 - **Programme View:** Press the ▲/▼ buttons to select the desired programme, then press the ENTER button. (Only for DIGITAL Channel)
 - **Edit Favourites:** Set channels you watch frequently as favourites.
 - ✎ Select the **Edit Favourites**, then press the ENTER button.
 - If the channel is already added to favourite channel, **Edit Favourites** will be shown.

- **Lock / Unlock:** Lock a channel so that the channel cannot be selected and viewed.

✎ This function is available only when the **Channel Lock** is set to **On**.

✎ The PIN input screen appears. Enter your 4-digit PIN, the default of which is "0-0-0-0". Change the PIN using the **Change PIN** option.

- **Edit Channel Name** (Only for Analogue channels): Assign your own channel name.

✎ This function may not support depending on the region.

- **Edit Channel Number:** Edit the number by pressing the number buttons desired.

✎ This function may not support depending on the region.

- **Delete:** You can delete a channel to display the channels you want.

- **Information:** Display the channel name, resolution, picture mode, language and so on. (Some just available for DTV)

- **Sort:** Change the list ordered by channel name or channel number. (Only for DIGITAL Channel)

- **Change antenna:** Switches to **Air** or **Cable**.

- **Edit Mode:** You can select desired channels and edit it.

- ◀▶ **(Ch. Mode):** Move to the type of channels you want to display on the **Channel List** screen.

✎ The option may differ depending on country.

- ↵ **(Watch / Information):** Watches the channel you select. / Displays details of the selected programme.

- ⏪ **(Page):** Move to next or previous page.

How to use Schedule Viewing in Channel List (Depending on the channels)

When you set the **Schedule Viewing** in **Channel List**, you can only set the programme in **Programme View**.

1. Press the CH LIST button, then select a desired digital channel.
2. Press the TOOLS button and select **Programme View**.
3. Press the ▲ / ▼ buttons to select the desired programme, then press the **(Information)** button.
4. Select **Schedule Viewing**, then press the ENTER button when done.

✎ If you want to cancel **Schedule Viewing**, follow steps 1 through 3. Select **Cancel Schedule**.

Basic Features

Channel Menu

Retuning Channels

MENU  → Channel → ENTER 

Aerial (Air / Cable)

Before your television can begin memorizing the available channels, you must specify the type of signal source that is connected to the LED display.

Country

(depending on the country)

The PIN input screen appears. Enter your 4 digit PIN number.

 Select your country so that the LED display can correctly auto-tune the broadcasting channels.

- **Digital Channel:** Change the country for digital channels.
- **Analogue Channel:** Change the country for analogue channels.

Auto Tuning

(depending on the country)

 Automatically allocated programme numbers may not correspond to actual or desired programme numbers. If a channel is locked using the **Channel Lock** function, the PIN input window appears.

■ Auto Tuning

- **Air / Cable:** Select the antenna source to memorise.
Digital & Analogue / Digital / Analogue: Select the channel source to memorise.

 When selecting **Cable** → **Digital & Analogue** or **Digital:** Provide a value to scan for cable channels.

- **Search Mode(Full / Network / Quick):** Selects the **Search Mode** settings among **Full / Network / Quick**.
- **Network (Auto / Manual):** Selects the **Network ID** setting mode among **Auto** or **Manual**.
- **Network ID:** When **Network** is **Manual**, you can set up **Network ID** using the numeric buttons.
- **Frequency:** Displays the frequency for the channel. (differs in each country)
- **Modulation:** Displays available modulation values.
- **Symbol Rate:** Displays available symbol rates.

■ Cable Search Option

(depending on the country)

Sets additional search options such as the frequency and symbol rate for a cable network search.

- **Start Frequency / Stop Frequency:** Set the start or stop frequency (differs in each country).
- **Symbol Rate:** Displays available symbol rates.
- **Modulation:** Displays available modulation values.

Manual Tuning

Scans for a channel manually and stores in the LED display.

 If a channel is locked using the **Channel Lock** function, the PIN input window appears.

■ Digital Channel Tuning:

 Scans for a digital channel.

1. Press the ENTER  button to select **New**.

 When selecting **Aerial** → **Air: Channel, Frequency, Bandwidth**

 When selecting **Aerial** → **Cable: Frequency, Modulation, Symbol Rate**

2. Press the ▼ button to select **Search**. When scanning has finished, a channel is updated in the channel list.

■ Analogue Channel Tuning:

 Scans for an analogue channel.

1. Press the ENTER  button to select **New**.
2. Set the **Programme, Colour System, Sound System, Channel** and **Search**.
3. Press the ▼ button to select **Store**. When scanning has finished, a channel is updated in the channel list.

Transfer Channel List

The PIN input screen appears. Enter your 4 digit PIN number. Imports or exports the channel map. You should connect a USB storage to use this function.

■ Import from USB:

 Import channel list from USB.

■ Export to USB:

 Export channel list to USB. This function is available when USB is connected.

 USB format should be FAT32.

Fine Tune

(analogue channels only)

If the reception is clear, you do not have to fine tune the channel, as this is done automatically during the search and store operation. If the signal is weak or distorted, fine tune the channel manually. Scroll to the left or right until the image is clear.

 Settings are applied to the channel you're currently watching.

 Fine tuned channels that have been saved are marked with an asterisk "*" on the right-hand side of the channel number in the channel banner

 To reset the fine-tuning, select **Reset**.

Basic Features

Picture Menu

Changing the Preset Picture Mode

MENU → Picture → Picture Mode → ENTER

Picture Mode

Select your preferred picture type.

When connecting a PC, the **Picture Mode** is only available like the **Standard** and **Entertain**.

- **Dynamic:** Suitable for a bright room.
- **Standard:** Suitable for a normal environment.
- **Movie:** Suitable for watching movies in a dark room.
- **Entertain:** Suitable for watching movies and games.
 - It is only available when connecting a PC.

Adjusting Picture Settings

MENU → Picture → ENTER

Samsung MagicAngle

Adjust screen viewing Angle to optimize screen quality according to your viewing position.

- **Samsung MagicAngle:** When viewing the screen at an angle from below or above by setting the appropriate mode for each position you can obtain a similar picture quality as viewing the screen directly from the front.
 - **Off:** Select when viewing from the front position.
 - **Lean back mode:** Select when viewing from a slightly lower position.
 - **Standing Mode:** Select when viewing from the upper position.
- **Mode:** Adjust screen viewing angle.

When **Samsung MagicAngle** is set to **Lean back mode** or **Standing Mode**, **Gamma** is not available.

Backlight / Contrast / Brightness / Sharpness / Colour / Tint (G/R)

Your television has several setting options for picture quality control.

NOTE

- In analogue **TV**, **PC**, **AV** modes of the PAL system, the **Tint (G/R)** function is not available.
- When connecting a PC, you can only make changes to **Backlight**, **Contrast**, **Brightness** and **Sharpness**.
- Settings can be adjusted and stored for each external device connected to the LED display.
- Lowering picture brightness reduces power consumption.

Screen Adjustment

- **Picture Size:** Your cable box / satellite receiver may have its own set of screen sizes as well. However, we highly recommend you use 16:9 mode most of the time.



Auto Wide: Automatically adjusts the picture size to the 16:9 aspect ratio.

16:9: Sets the picture to 16:9 wide mode.

Wide Zoom: Magnifies the picture size more than 4:3.

Adjusts the **Position** by using ▲ / ▼ buttons.

Zoom: Magnifies the 16:9 wide pictures vertically to fit the screen size.

Adjusts the **Zoom** or **Position** by using ▲ / ▼ button.

4:3: Sets the picture to basic (4:3) mode.

Do not watch in 4:3 format for a long time. Traces of borders displayed on the left, right and centre of the screen may cause image retention (screen burn) which are not covered by the warranty.

Screen Fit: Displays the full image without any cut-off when HDMI (720p / 1080i / 1080p) or Component (720p / 1080i / 1080p) signals are inputted.

Adjusts the **Position** by using ▲ / ▼ / ◀ / ▶ button.

NOTE

- Depending on the input source, the picture size options may vary.
- The available items may differ depending on the selected mode.
- When connecting a PC, only **16:9** and **4:3** modes can be adjusted.
- Settings can be adjusted and stored for each external device connected to an input on the LED display.
- If you use the **Screen Fit** function with HDMI 720p input, 1 line will be cut at the top, bottom, left and right as in the overscan function.

- **Zoom / Position:** You can adjust picture size and position by ▲ / ▼ / ◀ / ▶ button.

It's only available when picture size is set as **Zoom** and **Wide Zoom**.

In **Wide Zoom** mode, you can only use Position adjustment.

Reset: Reset the **Zoom** and **Position** to the default settings.

- **4:3 Screen Size (16:9 / Wide Zoom / Zoom / 4:3):**

Available only when picture size is set to **Auto Wide**.

You can determine the desired picture size at the 4:3 WSS (Wide Screen Service) size or the original size. Each European country requires different picture size.

Not available in HDMI, Component, and HDMI/DVI mode.

Basic Features

■ PC Screen Adjustment

 Available only PC mode.

- **Coarse / Fine:** Removes or reduces picture noise. If the noise is not removed by Fine-tuning alone, then adjust the frequency as best as possible (**Coarse**) and Finetune again. After the noise has been reduced, readjust the picture so that it is aligned to the centre of screen.
- **Position:** Adjusts the PC screen position with direction button (▲ / ▼ / ◀ / ▶).
- **Image Reset:** Resets the image to default settings.

Auto Adjustment

Frequency values / position and fine tune are adjusted automatically.

 It's only available in PC mode.

Using Your TV as a Computer (PC) Display

Setting Up Your PC Software (Based on Windows XP)
Depending on the version of Windows and the video card, the actual screens on your PC may differ in which case the same basic set-up information will almost always be applied. (If not, contact your computer manufacturer or Samsung Dealer.)

1. Click on "Control Panel" on the Windows start menu.
2. Click on "Appearance and Themes" in the "Control Panel" window and a display dialog-box will appear.
3. Click on "Display" and a display dialog box will appear.
4. Navigate to the "Settings" tab on the display dialog-box.
 - The correct size setting (resolution) [Optimum: 1920 x 1080 pixels]. (T19B300: 1366 x 768 pixels)
 - If a vertical-frequency option exists on your display settings dialog box, the correct value is "60" or "60 Hz". Otherwise, just click "OK" and exit the dialog box.

Maintaining the Correct Posture when Using this Product

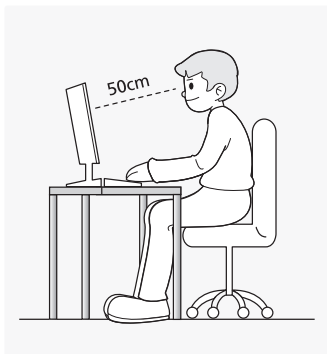



Maintain the correct posture when using this product.

- Straighten your back.
- Keep a distance of 45~50 cm (15~19 inches) from your eyes to the screen. Look down at the screen and face the screen forwards.
- Adjust the angle of the product so that light is not reflected onto the screen.

- Keep your elbow at a right angle and keep your arm level with the back of your hand.
- Keep your elbow at a right angle.
- Place your heels flat on the ground while keeping your knees at an angle of 90 degrees or higher and maintain the position of your arm so that your arm is below your heart.

Changing the Picture Options

Advanced Settings

MENU  → Picture → Advanced Settings → ENTER 

(Advanced Settings are available in Standard / Movie mode)
Compared to previous models, new Samsung LED display have a more precise picture.

 When connecting a PC, you can only make changes to **White Balance**.

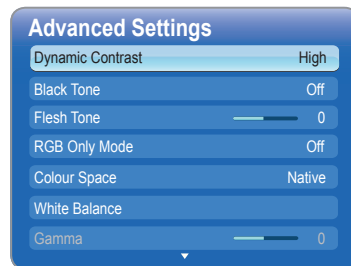

- **Dynamic Contrast (Off / Low / Medium / High):** Adjust the screen contrast.
- **Black Tone (Off / Dark / Darker / Darkest):** Select the black level to adjust the screen depth.
- **Flesh Tone:** Emphasize pink "Flesh Tone."
- **RGB Only Mode (Off / Red / Green / Blue):** Displays the Red, Green and Blue colour for making fine adjustments to the hue and saturation.
- **Colour Space (Auto / Native):** Adjust the range of colours available to create the image.
- **White Balance:** Adjust the colour temperature for a more natural picture.
 - R-Offset / G-Offset / B-Offset:** Adjust each colour's (red, green, blue) darkness.
 - R-Gain / G-Gain / B-Gain:** Adjust each colour's (red, green, blue) brightness.
 - Reset:** Resets the **White Balance** to it's default settings.
- **Gamma:** Adjust the primary colour intensity.
- **Motion Lighting (Off / On):** Reduce power consumption by brightness control.

Basic Features

Picture Options

MENU  → Picture → Picture Options → ENTER 

 When connecting a PC, you can only make changes to the **Colour Tone**.



■ Colour Tone (Cool / Standard / Warm1 / Warm2)

 **Warm1** or **Warm2** will be deactivated when the picture mode is **Dynamic**.

 Settings can be adjusted and stored for each external device connected to an input on the LED display.

■ Digital Noise Filter (Off / Low / Medium / High / Auto / Auto Visualisation):

If the broadcast signal received by your LED display is weak, you can activate the **Digital Noise Filter** feature to reduce any static and ghosting that may appear on the screen.

 When the signal is weak, try other options until the best picture is displayed.

Auto Visualisation: When changing analogue channels, displays signal strength.

 Only available for analogue channels.

 When bar is green, you are receiving the best possible signal.

■ MPEG Noise Filter (Off / Low / Medium / High / Auto):

Reduces MPEG noise to provide improved picture quality.

■ HDMI Black Level (Low / Normal):

Selects the black level on the screen to adjust the screen depth.

 Available only in HDMI mode (RGB signals).

■ Film Mode (Off / Auto1 / Auto2):

Sets the LED display to automatically sense and process film signals from all sources and adjust the picture for optimum quality.

 Available in TV mode, HDMI (1080i).

 If the screen does not seem natural, change its option to **Off / Auto1 / Auto2** in **Film Mode**.

Reset Picture (Yes / No)

Resets your current picture mode to its default settings.

Sound Menu

Changing the Preset Sound Mode

MENU  → Sound → Sound Mode → ENTER 

Sound Mode

- **Standard:** Selects the normal sound mode.
- **Music:** Emphasizes music over voices.
- **Movie:** Provides the best sound for movies.
- **Clear Voice:** Emphasizes voices over other sounds.
- **Amplify:** Increase the intensity of high-frequency sound to allow a better listening experience for the hearing impaired.

 If **Speaker Select** is set to **External Speaker**, **Sound Mode** is disabled.

Adjusting Sound Settings

Sound Effect

MENU  → Sound → Sound Effect → ENTER 

(standard sound mode only)

■ SRS TruSurround HD(Off / On)

This function provides a virtual 5.1 channel surround sound experience through a pair of speakers using HRTF (Head Related Transfer Function) technology.

■ SRS TruDialog (Off / On)

This function allows you to increase the intensity of a voice over background music or sound effects so that dialog can be heard more clearly.

■ Equalizer

Adjusts the sound mode.

- **Balance L/R:** Adjusts the balance between the right and left speaker.

100Hz / 300Hz / 1kHz / 3kHz / 10kHz (Bandwidth Adjustment): Adjusts the level of specific bandwidth frequencies.

- **Reset:** Resets the equaliser to its default settings.

Basic Features

Sound Systems, Etc.

MENU → Sound → ENTER

Broadcast Audio Options

Audio Language

(digital channels only)

Change the default value for audio languages.

The available language may differ depending on the broadcast.

Audio Format

(digital channels only)

Select the audio format.

Audio Description

(not available in all locations) (digital channels only)

This function handles the Audio Stream for the AD (Audio Description) which is sent along with the Main audio from the broadcaster.

Audio Description (Off / On): Turn the audio description function on or off.

Volume: Adjust the audio description volume.



Additional Settings

(digital channels only)

■ **DTV Audio Level (MPEG / HE-AAC):** This function allows you to reduce the disparity of a voice signal (which is one of the signals received during a digital TV broadcast) to a desired level.

According to the type of broadcast signal, **MPEG / HE-AAC** can be adjusted between -10dB and 0dB.

To increase or decrease the volume, adjust between the range 0 and -10 respectively.

■ **SPDIF Output:** SPDIF (Sony Philips Digital InterFace) is used to provide digital sound, reducing interference going to speakers and various digital devices such as a DVD player.

– **Audio Format:** You can select the Digital Audio output (SPDIF) format.

The available Digital Audio output (SPDIF) format may differ depending on the input source.

– **Audio Delay:** Correct audio-video sync problems, when watching TV or video, and when listening to digital audio output using an external device such as an AV receiver (0ms ~ 250ms).

It's not available for TB300 series.

■ **Dolby Digital Comp (Line / RF):** This function minimizes signal disparity between a dolby digital signal and a voice signal (i.e. MPEG Audio, HE-AAC, ATV Sound).

Select **Line** to obtain dynamic sound, and **RF** to reduce the difference between loud and soft sounds at night time.

Line: Set the output level for signals greater or less than -31dB (reference) to either -20dB or -31dB.

RF: Set the output level for signals greater or less than -20dB (reference) to either -10dB or -20dB.

Speaker Settings

■ **Speaker Select (External Speaker / TV Speaker):** A sound echo may occur due to a difference in decoding speed between the main speaker and the audio receiver. In this case, set the TV to **External Speaker**.

When **Speaker Select** is set to **External Speaker**, the volume and MUTE buttons will not operate and the sound settings will be limited.

When **Speaker Select** is set to **External Speaker**.

- **TV Speaker: Off, External Speaker: On**

When **Speaker Select** is set to **TV Speaker**.

- **TV Speaker: On, External Speaker: On**

If there is no video signal, both speakers will be mute.

It's not available for TB300 series.

■ **Auto Volume (Off / Normal / Night):** To equalize the volume level on each channel, set to **Normal**.

Night: This mode provides an improved sound experience compared to **Normal** mode, making almost no noise. It is useful at night.

Reset Sound (Yes / No)

Reset all sound settings to the factory defaults.

Selecting the Sound Mode

When you set to **Dual I II**, the current sound mode is displayed on the screen.

	Audio Type	Dual I-II	Default
A2 Stereo	Mono	Mono	Automatic change
	Stereo	Stereo ↔ Mono	
	Dual	Dual I ↔ Dual II	Dual I
NICAM Stereo	Mono	Mono	Automatic change
	Stereo	Mono ↔ Stereo	
	Dual	Mono ↔ Dual I ↖ Dual II ↙	Dual I

If the **Stereo** signal is weak and an automatic switching, occurs, then switch to the **Mono**.

Only activated in stereo sound signal.

Only available when the input **Source** is set to **TV**.

Basic Features

System Menu

Setting the Time

MENU → System → ENTER

Time

- **Clock:** Setting the clock is for using various timer features of the LED display.

The current time will appear every time you press the INFO button.

If you disconnect the power cord, you have to set the clock again.

Clock Mode (Auto / Manual)

- **Auto:** Set the current time automatically using the time from a digital channel.

The antenna must be connected in order to set the time automatically.

- **Manual:** Set the current time manually.

Depending on the broadcast station and signal, the auto time set up may not be correct. In this case, set the time manually.

Clock Set: Set the Day, Month, Year, Hour and Minute manually.

Available only when **Clock Mode** is set to **Manual**.

You can set the Day, Month, Year, Hour and Minute directly by pressing the number buttons on the remote control.

Time Zone (Auto / Manual) (depending on the country): Select your time zone.

This function is only available when the **Clock Mode** is set to **Auto**.

- **GMT(GMT-3:00~GMT-1:00 / GMT / GMT+1:00~GMT+ 12:00):** Selects your time zone.

This function is only available when the **Time Zone** is set to **Manual**.

- **DST(Daylight Saving Time) (Off / On):** Switches the Daylight Saving Time function on or of off.

This function is only available when the **Time Zone** is set to **Manual**.

Using the Sleep Timer

- **Sleep Timer** : Automatically shuts off the LED display after a preset period of time. (30, 60, 90, 120, 150 and 180 minutes).

To cancel **Sleep Timer**, select **Off**.

Setting the On / Off Timer

■ On Timer

On Timer 1 / On Timer 2 / On Timer 3: Three different on timer settings can be made. You must set the clock first.

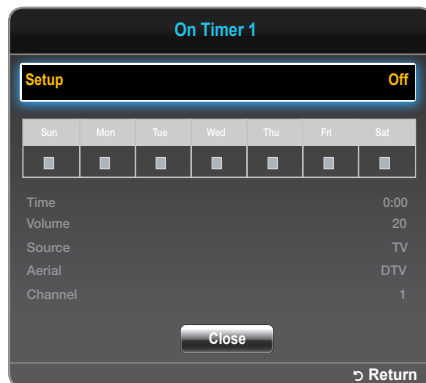

Setup: Select **Off**, **Once**, **Everyday**, **Mon~Fri**, **Mon~Sat**, **Sat~Sun** or **Manual** to set at your convenience. If you select **Manual**, you can set up the day you want to activate the timer.

The mark indicates the day you've selected.

Time: Set the hour and minute.

Volume: Set the desired volume level.

Source: Select a desired input source when the LED display is turned on automatically. (**USB** can be selected only when a USB device is connected to the LED display)

Aerial (when the **Source** is set to **TV**): Select **ATV** or **DTV**.

Channel (when the **Source** is set to **TV**): Select the desired channel.

Music / Photo (when the **Source** is set to **USB**): Select a folder in the USB device containing music or photo files to be played when the LED display is turned on automatically.

NOTE

- If there is no music file on the USB device or the folder containing a music file is not selected, the Timer function does not operate correctly.
- When there is only one photo file in the USB, the Slide Show will not play.
- If a folder name is too long, the folder cannot be selected.
- Each USB you use is assigned its own folder. When using more than one of the same type of USB, make sure the folders assigned to each USB have different names.
- It is recommended that you use a USB memory stick and a multi card reader when using **On Timer**.
- The **On Timer** function may not work with USB devices with a built-in battery, MP3 players, or PMPs made by some manufacturers because these devices take a long time to be recognized.

Basic Features

■ Off Timer

Off Timer 1 / Off Timer 2 / Off Timer 3: Three different off timer settings can be made. You must set the clock first.

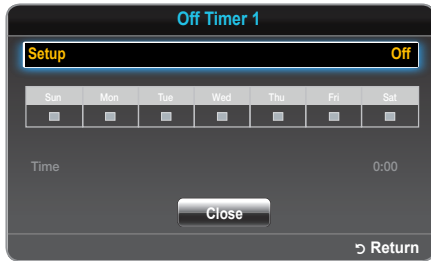

Setup: Select **Off**, **Once**, **Everyday**, **Mon~Fri**, **Mon~Sat**, **Sat~Sun** or **Manual** to set at your convenience. If you select **Manual**, you can set up the day you want to activate the timer.

The ✓ mark indicates the day you've selected.

Time: Set the hour and minute.

■ Locking Programmes

MENU → System → Security → ENTER

Security

- The PIN input screen appears before the setup screen.
- Enter your 4-digit PIN, the default of which is "0-0-0-0". Change the PIN using the **Change PIN** option.
- **Channel Lock (Off / On):** Lock channels in **Channel Manager**, to prevent unauthorized users, such as children, from watching unsuitable programme.
 - Available only when the input **Source** is set to **TV**.
- **Program Rating Lock** (depending on the country): Prevent unauthorized users, such as children, from watching unsuitable programme with a user-defined 4-digit PIN code. If selected channel is locked, the "🔒" symbol will be displayed.
 - The items of **Program Rating Lock** differs depending on the country.
- **Change PIN:** The **Change PIN** screen will appear. Choose any 4 digits for your PIN and enter them. Change your personal ID number required to set up the LED display. Re-enter the same 4 digits. When the Confirm screen disappears, your PIN has been memorised.

■ Economical Solutions

MENU → System → Eco Solution → ENTER

Eco Solution

- **Energy Saving (Off / Low / Medium / High / Picture Off)**
 TOOLS : This adjusts the brightness of the LED display in order to reduce power consumption. If you select **Picture Off**, the screen is turned off, but the sound remains on. Press any button except volume button to turn on the screen.
- **No-Signal Power Off (Off / 15 min / 30 min / 60 min):** To avoid unnecessary energy consumption, set how long you want the LED display to remain on if it's not receiving a signal.
 - Disabled when the PC is in power saving mode.
- **Auto Power Off (Off / On):** Saves power by turning LED display off automatically when no user operation is received for 4 hours.

■ Other Features

MENU → System → ENTER

Language

- **Menu Language:** Set the menu language.
- **Teletext Language:** Set a desired language for teletext.
 - English is the default in cases where the selected language is unavailable in the broadcast.
- **Preferred Language (Primary Audio / Secondary Audio / Primary Subtitle / Secondary Subtitle):** Select a language, which will be the default language when a channel is selected.

Subtitle

Use this menu to set the **Subtitle** mode.

- **Subtitle (Off / On):** Switches subtitles on or off.
- **Subtitle Mode (Normal / Hearing Impaired):** Sets the subtitle mode.
- **Subtitle Language:** Sets the subtitle language.
 - If the programme you are watching does not support the **Hearing Impaired** function, **Preferred** automatically activates even if the **Hearing Impaired** mode is selected.
 - English is the default in cases where the selected language is unavailable in the broadcast.



Basic Features

Digital Text (Disable / Enable)

(UK only)

If the programme broadcasts with digital text, this feature is enabled.

Auto Protection Time

- **Off / 2 hours / 4 hours / 8 hours / 10 hours:** If the screen remains idle with a still image for a certain period of time defined by the user, the screen saver is activated to prevent the formation of ghost images on the screen.

General

- **Max. Power Saving (Off / On):** Turn off PC monitor when PC is not used for certain length of time to reduce power consumption.
- **Game Mode (Off / On):** When connecting to a game console such as PlayStation™ or Xbox™, you can enjoy a more realistic gaming experience by selecting game mode.

NOTE

- Precautions and limitations for game mode
 - To disconnect the game console and connect another external device, set **Game Mode** to **Off** in the setup menu.
 - If you display the LED display menu in **Game Mode**, the screen shakes slightly.
- **Game Mode** is not available when the input source is set to **TV** or **PC**.
- After connecting the game console, set **Game Mode** to **On**. Unfortunately, you may notice reduced picture quality.
- If **Game Mode** is **On**:
 - **Picture** mode is set to **Standard** and **Sound** mode is set to **Movie**.
- **Panel Lock (Off / On):** Lock or unlock all the keys on the front panel at once. When Panel Lock is on, none of the keys on the front panel operate.
- **Boot Logo (Off / On):** Display Samsung logo when the LED display is turned on.

Common Interface

- **CI Menu:** This enables the user to select from the CAM-provided menu. Select the CI Menu based on the menu PC Card.
- **Application Info:** View information on the CAM inserted into the CI slot and on the "CI or CI+ CARD" which is inserted into the CAM. You can install the CAM anytime whether the LED display is on or off.

1. Purchase a CI CAM module at your nearest dealer or by phone.
2. Firmly insert the "CI or CI+ CARD" into the CAM in the direction of the arrow.
3. Insert the CAM with the "CI or CI+ CARD" into the common interface slot, in the direction of the arrow so that it aligns parallel with the slot.
4. Check if you can see a picture on a scrambled signal channel.

Picture In Picture (PIP)

MENU  → System → PIP → ENTER 







PIP

You can watch the LED display tuner and one external video source simultaneously. **PIP** (Picture-in-Picture) does not function in the same mode.

NOTE

- For PIP sound, refer to the **Sound Select** instructions.
- If you turn the LED display off while watching in **PIP** mode, the PIP window will disappear.
- You may notice that the picture in the PIP window becomes slightly unnatural when you use the main screen to view a game or karaoke.
- While **Program Rating Lock** is in operation, the PIP function cannot be used.
- PIP settings

Main picture	Sub picture
HDMI, HDMI(PC), Component, PC	TV

- **PIP (Off / On):** Activate or deactivate the PIP function.
- **Channel:** Select the channel for the sub-screen.
- **Size ( / ):** Select a size for the sub-picture.
- **Position ( /  /  / ):** Select a position for the sub-picture.
- **Sound Select (Main / Sub):** You can choose the desired sound (**Main / Sub**) in **PIP** mode.

DivX® Video On Demand

Shows the registration code authorized for the TV. If you connect to the DivX web site and register, you can download the VOD registration file. If you play the VOD registration using Media contents, the registration is completed.

 For more information on DivX® VOD, visit "http://vod.divx.com".

Basic Features

Support Menu

MENU  → Support → ENTER 

Self Diagnosis

-  **Self Diagnosis** might take few seconds, this is part of the normal operation of the LED display
- **Picture Test (Yes / No):** Use to check for picture problems.
Yes: If the test pattern does not appear or there is noise in the test pattern, select **Yes**. There may be a problem with the LED display. Contact Samsung's Call Centre for assistance.
No: If the test pattern is properly displayed, select **No**. There may be a problem with your external equipment. Please check your connections. If the problem persists, refer to the external device's user manual.
- **Sound Test (Yes / No):** Use the built-in melody sound to check for sound problems.
Yes: If you can hear sound only from one speaker or not at all during the sound test, select **Yes**. There may be a problem with the LED display. Contact Samsung's Call Centre for assistance.
No: If you can hear sound from the speakers, select **No**. There may be a problem with your external equipment. Please check your connections. If the problem persists, refer to the external device's user manual.
- **Signal Information:** (digital channels only) An HD channel's reception quality is either perfect or the channels are unavailable. Adjust your antenna to increase signal strength.
- **Reset:** Restores all settings to factory defaults except network settings.

Software Upgrade



Software Upgrade can be performed via a broadcasting signal or downloading the latest firmware from "www.samsung.com," to a USB memory device.

Current Version the software already installed in the LED display.

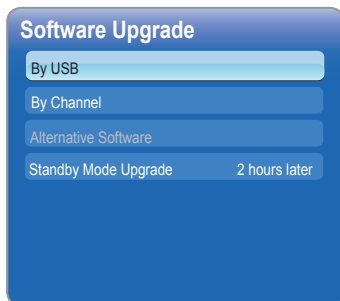
 Software is represented as "Year/Month/Day_Version".

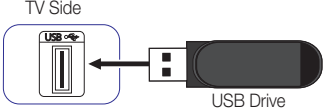

Installing the Latest Version

- **By USB:** Insert a USB drive containing the firmware upgrade file, downloaded from  "www.samsung.com," into the TV. Please be careful not to disconnect the power or remove the USB drive until upgrades are complete. The TV will be turned off and on automatically after completing the firmware upgrade. When software is upgraded, video and audio settings you have made will return to their default settings. We advise you to write down your settings so that you can easily reset them after the upgrade.
- **By Channel:** Upgrade the software using the broadcasting signal.
 -  If the function is selected during the software transmission period, software will be automatically searched and downloaded.
 -  The time required to download the software is determined by the signal status.
- **Alternative Software:** Replace the current software with the alternative.
- **Standby Mode Upgrade (Off / 1 hour later / 2 hours later / 00:00 / 02:00 / 12:00 / 14:00):** A manual upgrade will be automatically performed at selected time. Since the power of the unit is turned on internally, the screen may be turned on slightly for the LED product. This phenomenon may continue for more than 1 hour until the software upgrade is complete.

Contact Samsung

View this information when your LED display does not work properly or when you want to upgrade the software. You can find information regarding our call centres, and how to download products and software.

Contents Home

You can enjoy useful and various contents.

Advanced Features

Using the Media Play

Enjoy videos, photos, music files saved on a USB Mass Storage Class (MSC) device.

1. Press the **CONTENT** button.
2. Press the ◀ / ▶ button to select desired menu (**Media Play**), then press the **ENTER** button.

CONTENT → **Media Play** → **ENTER**

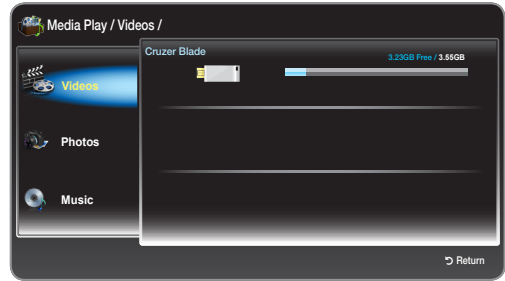

- The displayed image may differ depending on the model.

Connecting a USB Device

1. Turn on your TV.
2. Connect a USB device containing photo and music files to the **USB** jack on the side of the TV.
3. When USB is connected to the TV, popup window appears. Then you can select **Device connected**.

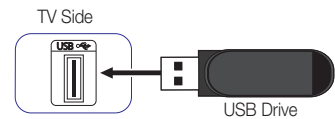

✎ It might not work properly with unlicensed multimedia files.

✎ Need-to-Know List before using **Media Play**.

- MTP (Media Transfer Protocol) is not supported.
- The file system supports FAT16, FAT32 and NTFS.
- Certain types of USB Digital camera and audio devices may not be compatible with this TV.
- **Media Play** only supports USB Mass Storage Class (MSC) devices. MSC is a Mass Storage Class Bulk-Only Transport device. Examples of MSC are Thumb drives, Flash Card Readers and USB HDD (USB HUB are not supported). Devices should be connected directly to the TV's USB port.
- USB (HDD) is not supported.
- Before connecting your device to the TV, please back up your files to prevent them from damage or loss of data. SAMSUNG is not responsible for any data file damage or data loss.
- Do not disconnect the USB device while it is loading.
- The higher the resolution of the image, the longer it takes to display on the screen.
- The maximum supported JPEG resolution is 15360 x 8640 pixels.
- For unsupported or corrupted files, the "Not Supported File Format" message is displayed.
- MP3 files with DRM that have been downloaded from a non-free site cannot be played. Digital Rights Management (DRM) is a technology that supports the creation, distribution and management of the content in an integrated and comprehensive way, including the protection of the rights and interests of the content providers, the prevention of the illegal copying of contents, as well as managing billings and settlements.
- If more than 2 PTP devices are connected, you can only use one at a time.
- If more than two MSC devices are connected, some of them may not be recognized. A USB device that requires high power (more than 500mA or 5V) may not be supported.
- If an over-power warning message is displayed while you are connecting or using a USB device, the device may not be recognized or may malfunction.

Advanced Features

- If the TV has been no input during time set in **Auto Protection Time**, the Screensaver will run.
- The power-saving mode of some external hard disk drives may be released automatically when connected to the TV.
- If a USB extension cable is used, the USB device may not be recognized or the files on the device may not be read.
- If a USB device connected to the TV is not recognized, the list of files on the device is corrupted or a file in the list is not played, connect the USB device to the PC, format the device and check the connection.
- **Media Play** only supports sequential jpeg format.

Screen Display

Move to the desired file using the ▲ / ▼ / ◀ / ▶ buttons and then press the ENTER button. The file is played. **Media Play** screen may differ depending on the way to enter the screen.

Information:
Displays the selected content category (Music, for example), device (USB drive, for example), folder/file name and page.

Contents mode:
You can select the desired Content Category.

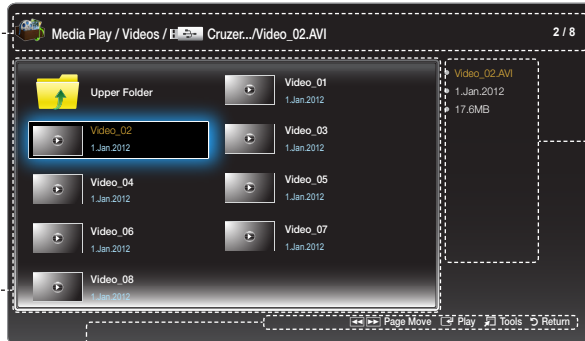

Displays the selected file information.

- The displayed image may differ depending on the model.

Operation Buttons

- ◀◀ Turn to the previous page. Only available in **Music**.
- ▶▶ Turn to the next page. Only available in **Music**.
- ▶ Play: Play the media file.
- 🛠 Tools: Displays the option menu.
- ↶ Return: Move to the previous step.

Advanced Features

Videos

Playing Video

1. Press the ◀ / ▶ / ▲ / ▼ button to select the desired video in the file list.
2. Press the ENTER (↵) button or ▶ (Play) button.
 - The selected file name is displayed on the top with its playing time.
 - If video time information is unknown, play time and progress bar are not displayed.
 - During video playback, you can search using ◀ and ▶ button.
 - You can use ◀◀ (REW) and ▶▶ (FF) buttons during playback.

 In this mode, you can enjoy movie clips contained on a Game, but you cannot play the Game itself.

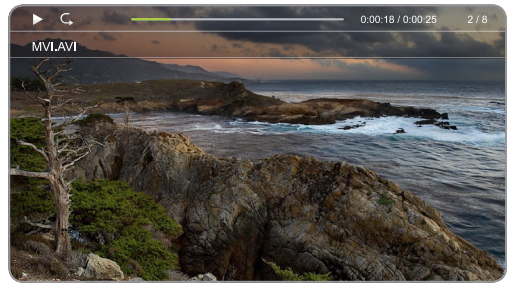

- The displayed image may differ depending on the model.

Supported Subtitle Formats

– External

Name	Extension
MPEG-4 Timed text	.txt
SAMI	.smi
SubRip	.srt
SubViewer	.sub
Micro DVD	.sub or .txt
SubStation Alpha	.ssa
Advanced SubStation Alpha	.ass
Powerdivx	.psb

– Internal

Name	Container
Xsub	AVI
SubStation Alpha	MKV
Advanced SubStation Alpha	MKV
SubRip	MKV
MPEG-4 Timed text	MP4

Advanced Features

Supported Video Formats

File Extension	Container	Video Codec	Resolution	Frame rate (fps)	Bit rate (Mbps)	Comments	Audio Codec
*.avi *.mkv *.asf *.wmv *.mp4 *.3gp *.vro *.mpg *.mpeg *.ts *.tp *.trp *.m2ts *.mts *.divx	AVI MKV ASF MP4 3GP VRO VOB PS TS	DivX 3.11 / 4.x / 5.1 / 6.0	1920 x 1080	30	20 [40]	GMC Not Support	AC3 LPCM ADMP3(M, MS) AAC HE-AAC WMA DD+ MPEG(MP3) DTS Core Vorbis
		MPEG4 SP / ASP				Not Include FMO / ASO / RS Support BP / MP / HP Level 4.1	
		H.264 BP / MP / HP				Profile3, restricted up to SD resolution	
		H.263	640 x 480		10		
		Motion JPEG	640 x 480		10		
		Window Media Video v9	1920 x 1080		20 [40]	VC1 SP / MP / A P L3 Support, L4 Not Support Simple Profile Medium Level Main Profile High Level Advanced Profile Level 3 WMV9 support	
		MPEG2				High Profile High Level	
		MPEG1				MPEG-1 except D-picture	

Advanced Features

Other Restrictions



NOTE

- If there are problems with the contents of a codec, the codec will not be supported.
- If the information for a Container is incorrect and the file is in error, the Container will not be able to play correctly.
- Sound or video may not work if the contents have a standard bitrate/frame rate above the compatible Frame/ sec listed in the table above.
- If the Index Table is in error, the Seek (Jump) function is not supported.
- You may experience file stuttering while playing a video through a network connection.

Name	Format
<ul style="list-style-type: none"> • Supports up to H.264, Level 4.1 • H.264 FMO / ASO / RS, VC1 SP / MP / AP L4 and AVCHD are not supported. • MPEG4 SP, ASP: <ul style="list-style-type: none"> – Below 1280 x 720: 60 frame max – Above 1280 x 720: 30 frame max • GMC 2 over is not supported. 	<ul style="list-style-type: none"> • Supports up to WMA 7, 8, 9, STD • WMA 9 PRO does not support 2 channel excess multi channel or lossless audio. • WMA sampling rate 22050Hz mono is not supported.

Photos

Viewing a Photo (or Slide Show)

1. Press the ▲ / ▼ / ◀ / ▶ button to select the desired photo in the file list.
2. Press the ENTER  button.
 - When a selected photo is displayed, press the ENTER  button to start the slide show.
 - During the slide show, all files in the file list will be displayed in order.

 Music files can be automatically played during the Slide Show if the **Background Music** is set to **On**.

 The **Background Music** cannot be changed until the BGM has finished loading.



- The displayed image may differ depending on the model.

Supported Picture Formats

File Extension	Format	Resolution
*.jpg	JPEG	15360 x 8640
*.bmp	BMP	1920 x 1080
*.mpo	MPO	15360 x 8640

Advanced Features

Music

Playing Music

1. Press the ▲ / ▼ button to select the desired **Music** in the file list.
 2. Press the ENTER button.
- ✎ Only displays the files with the file extension in following supported music formats list. Other file extensions are not displayed, even if they are saved on the same USB device.
 - ✎ If the sound is abnormal when playing MP3 files, adjust the **Equaliser** in the **Sound** menu. (An over-modulated MP3 file may cause a sound problem.)

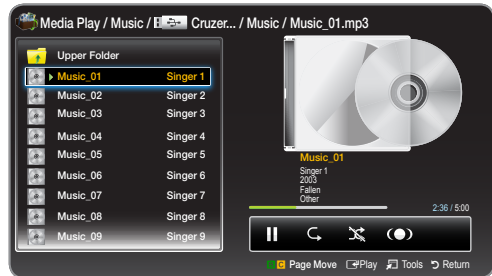

- The displayed image may differ depending on the model.

Playing selected music

1. Press the TOOLS button and select **Play Selection**.
2. Select the desired music.
 - ✎ The ✓ mark appears to the left of the selected files.
3. Press the TOOLS button and select **Play Selection**.
 - ✎ You can select or deselect all music pressing the **Select All / Deselect All**.

Supported Music Formats

File Extension	Type	Codec
*.mp3	MPEG	MPEG1 Audio Layer 3
*.m4a *.mpa *.aac *.3ga	MPEG4	AAC
*.flac	FLAC	FLAC
*.ogg	OGG	Vorbis
*.wma	WMA	WMA

Advanced Features

Media Play - Additional Functions

Videos/Photos/Music Play Option menu

Press the **TOOLS**  button and you can make the following operations.







Category	Operations	Videos	Photos	Music
Shuffle Mode	You can play the music randomly.			▼
Repeat Mode	You can play media files repeatedly.	▼		▼
Picture Mode	You can adjust the picture setting.	▼	▼	
Sound Mode	You can adjust the sound setting.	▼	▼	▼
Start Slide Show / STOP Slide Show	You can start or pause a Slide Show.		▼	
Slide Show Speed	You can select the slide show speed during the slide show.		▼	
Background Music	You can on/off background music when watching a Slide Show.		▼	
Background Music Setting	You can select background music when watching a Slide Show.		▼	
Zoom	You can zoom into images in full screen mode.		▼	
Rotate	You can rotate images in full screen mode.		▼	
Information	You can see detailed information about the played file.	▼	▼	▼
Play Selection	You can play the items what you selected.	▼	▼	▼
Title Search	You can move directly to another Title.	▼		
Time Search	You can search the movie using ◀ and ▶ buttons at intervals of 1 minute.	▼		
Picture Size	You can adjust the picture size to your preference.	▼		
Subtitle	You can set the subtitle On / Off .	▼		
Subtitle Settings	Play a video file with captions displayed. This option is available only when the caption file name matches the video file name.	▼		
Audio language	View a video in a supported language of your choice. The option is available only when a stream-type file that supports multiple audio formats is played.	▼		

Other Information





Analogue Channel Teletext Feature

The index page of the Teletext service gives you information on how to use the service. For Teletext information to be displayed correctly, channel reception must be stable. Otherwise, information may be missing or some pages may not be displayed.

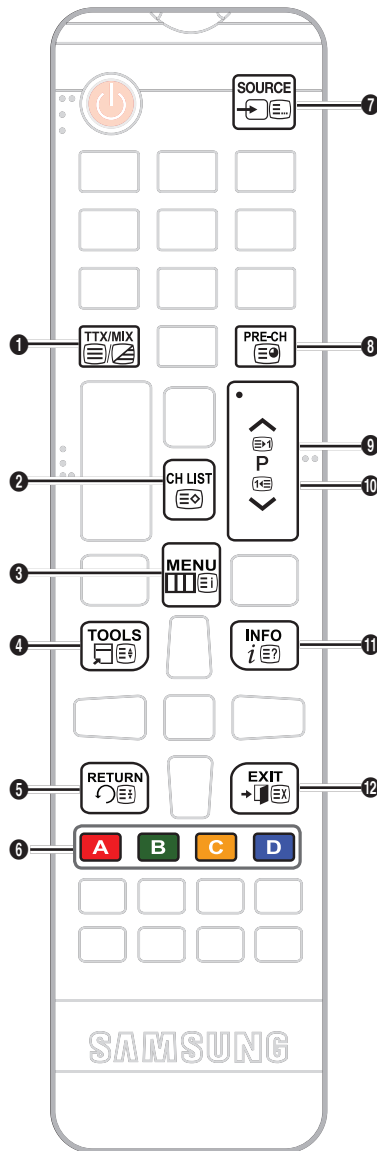
 You can change Teletext pages by pressing the numeric buttons on the remote control.

- 1  (Teletext on/mix/off): Activates the Teletext mode for the current channel. Press the button twice to overlap the Teletext mode with the current broadcasting screen. Press it one more time to exit teletext.
- 2  (store): Stores the Teletext pages.
- 3  (index): Displays the index (contents) page at any time while you are viewing Teletext.
- 4  (size): Displays the teletext on the upper half of the screen in double-size. To move the text to the lower half of the screen, press it again. For normal display, press it once again.
- 5  (hold): Holds the display at the current page, in the case that there are several secondary pages that follow automatically. To undo, press it again.
- 6 Colour buttons (red, green, yellow, blue): If the FASTEXT system is used by the broadcasting company, the different topics on a Teletext page are colour-coded and can be selected by pressing the coloured buttons. Press the colour corresponding to the topic of your choice. A new colour-coded page is displayed. Items can be selected in the same way. To display the previous or next page, press the corresponding coloured button.
- 7  (mode): Selects the Teletext mode (LIST/ FLOF).
If pressed during LIST mode, switches the mode to List save mode. In List save mode, you can save a Teletext page into a list using the  (store) button.



- 8  (sub-page): Displays the available sub-page.
- 9  (page up): Displays the next Teletext page.
- 10  (page down): Displays the previous Teletext page.
- 11  (reveal): Displays the hidden text (answers to quiz games, for example). To display the normal screen, press it again.
- 12  (cancel): Shrinks the Teletext display to overlap with the current broadcast.

Typical Teletext page

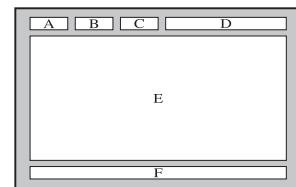

Part	Contents
A	Selected page number.
B	Broadcasting channel identity.
C	Current page number or search indications.
D	Date and time.
E	Text.
F	Status information. FASTEXT information.

Other Information

Attaching a Wall Mount/Desktop Stand

Preparing before installing Wall-Mount/Desktop Stand

1. Turn the product off and unplug the power cord from the wall outlet.
2. Place a soft cloth or cushion on a flat surface to protect the panel and place the product face down.
3. Hold the main body of the product with your hand. Pull the stand in the direction of the arrow as shown in the figure to separate it.

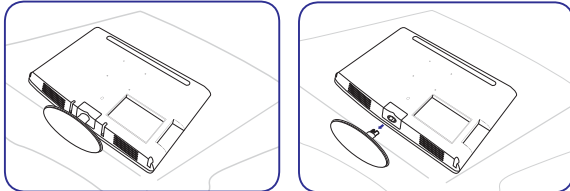

Attaching a Wall Mount/Desktop Stand

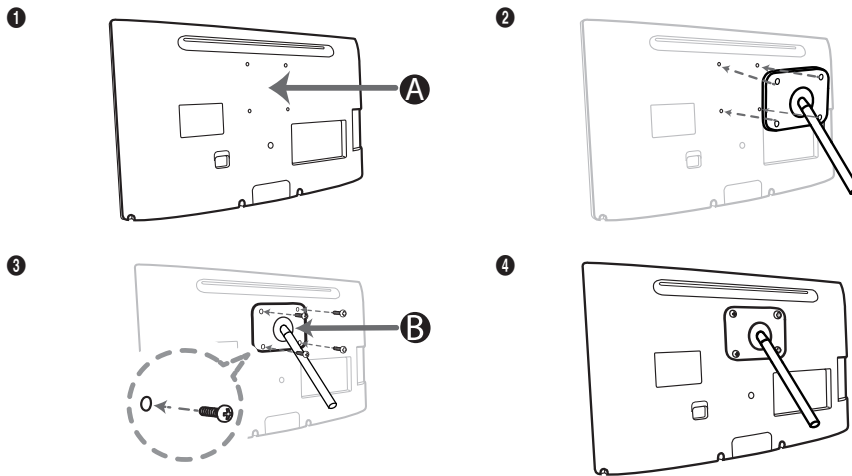

- A Wall/Desktop Stand Mount
- B Wall mount kit/desktop stand (not supplied)

⚠ Caution

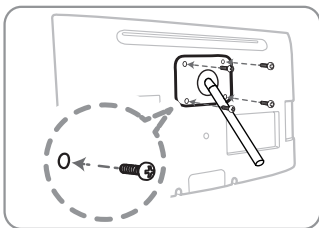

Important

For the installation of Wall-mount, please don't use screws longer than 14mm(L14) of longitude.

4. Align wall mount/desktop stand to the Monitor/LED display and firmly fix the wall mount/desktop stand by fastening the screw.
5. Align the groove of the part of the product that is to be connected to the stand with the groove in the stand (desk-top stand, wall mount stand or another stand) and firmly fix the stand by fastening the screw.



Other Information

NOTE

- If you use screws that are longer than the standard specifications, the inside of the product may be damaged.
- For wall mounts that are not compatible with the standard VESA specifications, the length of the screw may differ depending on the corresponding specifications.
- Avoid using screws that are incompatible with the standard VESA specifications and avoid assembling them using excessive force. This may result in damage to the product or injury due to the product falling. Samsung shall not be held liable for any damage or injury.
- Samsung shall not be held liable for any damage to the product or injury caused by using a wall mount/desktop stand that is not compatible with the specifications or due to an installation not performed by an authorized installation engineer.
- When installing the product using a wall mount, purchase a wall mount that provides at least 10 cm (3.93 inches) of space from the wall.
- Use the wall mount according to the international specifications.

Anti-theft Kensington Lock

The Kensington Lock is not supplied by Samsung. It is a device used to physically fix the system when using it in a public place. The appearance and locking method may differ from the illustration depending on the manufacturer. Refer to the manual provided with the Kensington Lock for additional information on proper use.

-  Please find a “” icon on the rear of the LED display. A Kensington slot is beside the “” icon.

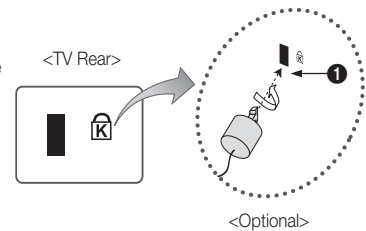

To lock the product, follow these steps:

1. Wrap the Kensington lock cable around a large, stationary object such as desk or chair.
2. Slide the end of the cable with the lock attached through the looped end of the Kensington lock cable.
3. Insert the locking device into the Kensington slot on the product (❶).
4. Lock the lock.

-  These are general instructions. For exact instructions, see the User manual supplied with the locking device.

-  The locking device has to be purchased separately.

-  The location of the Kensington slot may be different depending on the LED display model.

Other Information

Troubleshooting

If you have any questions about the LED display, first refer to this list. If none of these troubleshooting tips apply, please visit “www.samsung.com,” then click on Support, or contact the call centre listed on the back-cover of this manual.

Issues	Solutions and Explanations
Picture Quality	First of all, please perform the Picture Test and confirm that your LED display is properly displaying test image. (go to MENU - Support - Self Diagnosis - Picture Test) If the test image is properly displayed, the poor picture may be caused by the source or signal.
The LED display image does not look as good as it did in the store.	<ul style="list-style-type: none"> • If you have an analogue cable/set top box, upgrade to a digital set top box. Use HDMI to deliver HD (high definition) picture quality. • Cable/Satellite subscribers: Try HD stations from the channel line up. • Antenna connection: Try HD stations after performing Auto tuning. •  Many HD channels are up scaled from SD(Standard Definition) contents. • Adjust the Cable/Set top box video output resolution to 1080i or 720p. • Make sure you are watching the LED display at the minimum recommended distance based on the size and definition of the signal.
The picture is distorted: macroblock error, small block, dots, pixelization	<ul style="list-style-type: none"> • Compression of video contents may cause picture distortion especially in fast moving pictures such as sports and action movies. • Low signal level or bad quality can cause picture distortion. This is not a LED display issue. • Mobile phones used close to the LED display (cca up to 1m) may cause noise in picture on analogue and digital LED display.
There is poor colour or brightness.	<ul style="list-style-type: none"> • Adjust the Picture options in the LED display menu. (go to Picture Mode / Colour / Brightness / Sharpness) • Adjust Energy Saving option in the LED display menu. (go to MENU - System - Eco Solution - Energy Saving) • Try resetting the picture to view the default picture settings. (go to MENU - Picture - Reset Picture)
There is a dotted line on the edge of the screen.	<ul style="list-style-type: none"> • If the picture size is set to Screen Fit, change it to 16:9. • Change cable/satellite box resolution.
When changing channels, the picture freezes or is distorted or delayed.	<ul style="list-style-type: none"> • If connected with a cable box, please try to reset the cable box. Reconnect the AC cord and wait until the cable box reboots. It may take up to 20 minutes. • Set the output resolution of the cable box to 1080i or 720p.
Sound Quality	First of all, please perform the Sound Test to confirm that your LED display audio is properly operating. (go to MENU - Support - Self Diagnosis - Sound Test) If the audio is OK , the sound problem may be caused by the source or signal.
There is no sound or the sound is too low at maximum volume.	<ul style="list-style-type: none"> • Please check the volume of the device (Cable/Sat Box, DVD, Blu-ray etc) connected to your LED display.
The picture is good but there is no sound.	<ul style="list-style-type: none"> • If you are using a DVI to HDMI cable, LED display set does not support audio. • Reboot the connected device by reconnecting the device's power cable. • If your LED display has a headphone jack, make sure there is nothing plugged into it.
The speakers are making an inappropriate noise.	<ul style="list-style-type: none"> • For antenna or cable connections, check the signal strength. Low signal level may cause sound distortion.
No Picture, No Video	
The LED display will not turn on.	<ul style="list-style-type: none"> • Make sure the AC power cord is securely plugged in to the wall outlet and the LED display. • Make sure the wall outlet is working. • Try pressing the POWER button on the LED display to make sure the problem is not the remote. If the LED display turns on, refer to “The remote control does not work” below.
The LED display turns off automatically.	<ul style="list-style-type: none"> • Ensure the Sleep Timer is set to Off in the Time menu. • If your PC is connected to the LED display, check your PC power settings. • Make sure the AC power cord is plugged in securely to the wall outlet and the LED display. • When watching LED display from an antenna or cable connection, the LED display will turn off after 10 ~ 15 minutes if there is no signal.

Other Information



Issues	Solutions and Explanations
There is no picture/video.	<ul style="list-style-type: none"> • Check cable connections (remove and reconnect all cables connected to the LED display and external devices). • Set your external devices' (Cable/Set top Box, DVD, Blu-ray etc) video outputs to match the connections to the LED display input. For example, if an external device's output is HDMI, it should be connected to an HDMI input on the LED display. • Make sure your connected devices are powered on. • Be sure to select the LED display correct source by pressing the SOURCE button on the LED display remote. • Reboot the connected device by reconnecting the device's power cable.
RF(Cable/Antenna) Connection	
The LED display is not receiving all channels.	<ul style="list-style-type: none"> • Make sure the Antenna cable is connected securely. • Please try Setup (Initial setup) to add available channels to the channel list. Go to MENU - System - Setup (Initial setup) and wait for all available channels to be stored. • Verify the Antenna is positioned correctly.
The picture is distorted: macro block error small block, dots, pixelization.	<ul style="list-style-type: none"> • Compression of video contents may cause picture distortion, especially on fast moving pictures such as sports and action movies. • A low signal can cause picture distortion. This is not a LED display issue.
Others	
The picture will not display in full screen.	<ul style="list-style-type: none"> • HD channels will have black bars on either side of the screen when displaying up scaled SD (4:3) contents. • Black bars on the top and bottom will appear during movies that have aspect ratios different from your LED display. • Adjust the picture size options on your external device or LED display to full screen.
The remote control does not work.	<ul style="list-style-type: none"> • Replace the remote control batteries with the poles (+/-) in the right direction. • Clean the sensor's transmission window on the remote. • Try pointing the remote directly at the LED display from 5~6 feet away.
The cable/set top box remote control doesn't turn the LED display on or off, or adjust the volume.	<ul style="list-style-type: none"> • Programme the Cable/Set top box remote control to operate the LED display. Refer to the Cable/Set user manual for the SAMSUNG LED display code.
A " Mode Not Supported " message appears.	<ul style="list-style-type: none"> • Check the supported resolution of the LED display, and adjust the external device's output resolution accordingly.
There is a plastic smell from the LED display.	<ul style="list-style-type: none"> • This smell is normal and will dissipate over time.
The LED display Signal Information is unavailable in the Self Diagnosis Test menu.	<ul style="list-style-type: none"> • This function is only available with digital channels from an Antenna / RF / Coax connection.
LED display is tilted to the right or left side.	<ul style="list-style-type: none"> • Remove the stand base from the LED display and reassemble it.
There are difficulties assembling the stand base.	<ul style="list-style-type: none"> • Make sure the LED display is placed on a flat surface. If you can not remove the screws from the LED display, please use a magnetized screw driver.
The Channel menu is grey out (unavailable).	<ul style="list-style-type: none"> • The Channel menu is only available when the LED display source is selected.
Your settings are lost after 30 minutes or every time the LED display is turned off.	<ul style="list-style-type: none"> • If the LED display is in the Store Demo mode, it will reset audio and picture settings every 30 minutes. Change the settings from Store Demo mode to Home Use mode in the Setup (Initial setup) procedure. Press the SOURCE button to select TV mode, and go to MENU → System → Setup (Initial setup) → ENTER .
You have intermittent loss of audio or video.	<ul style="list-style-type: none"> • Check the cable connections and reconnect them. • Loss of audio or video can be caused by using overly rigid or thick cables. Make sure the cables are flexible enough for long term use. If mounting the LED display to the wall, we recommend using cables with 90 degree connectors.
You see small particles when you look closely at the edge of the frame of the LED display.	<ul style="list-style-type: none"> • This is part of the product's design and is not a defect.

Other Information

Issues	Solutions and Explanations
The PIP menu is not available.	<ul style="list-style-type: none"> PIP functionality is only available when you are using a HDMI source.
You turned the LED display off 45 minutes ago, and it turned on again.	<ul style="list-style-type: none"> It is normal. The LED display operates the OTA (Over The Aerial) function itself to upgrade firmware downloaded whilst your watching LED display.
The message "Scramble signal" or "Weak Signal/No Signal" appears.	<ul style="list-style-type: none"> If you are using a CAM CARD (CI/CI+), check that it is installed into the common interface slot. If there is still a problem, pull the CAM CARD out of the LED display and insert it into the slot again.
There are recurrent picture/sound issues.	<ul style="list-style-type: none"> Check and change the signal/source.
A reaction may occur between the rubber cushion pads on the base stand and the top finish of some furniture.	<ul style="list-style-type: none"> To prevent this, use felt pads on any surface of the LED display that comes in direct contact with furniture.

 This panel uses a panel consisting of sub pixels which require sophisticated technology to produce. However, there may be a few bright or dark pixels on the screen. These pixels will have no impact on the performance of the product.

Storage and Maintenance

-  If you attached some stickers on the LED display screen, it remains some debris after removing the sticker. Please clean it to watch LED display.
-  The exterior and screen of the product can get scratched during cleaning. Be sure to wipe the exterior and screen carefully using the cloth provided or a soft cloth to prevent scratches.

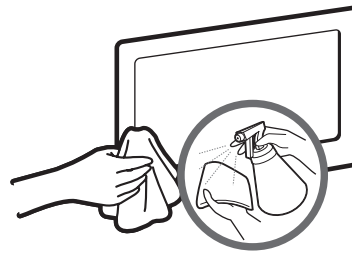
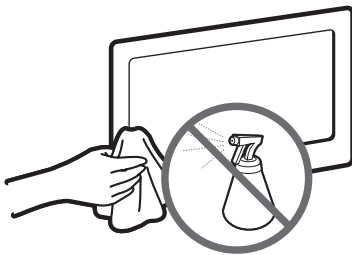

Do not spray water or a cleaning agent directly onto the product. Any liquid that goes into the product may cause a failure, fire, or electric shock.

Clean the product with a soft cloth dipped in a small amount of water.

CAUTION

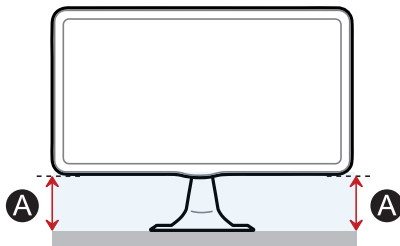

If the height of "A" on one side is different from the other side, adjust the heights.

Other Information

Licence



TheaterSound HD, SRS and the  symbol are trademarks of SRS Labs, Inc. TheaterSound HD technology is incorporated under licence from SRS Labs, Inc.



Manufactured under licence from Dolby Laboratories. Dolby and the double-D symbol are trademarks of Dolby Laboratories.



Manufactured under license under U.S. Patent Nos: 5,956,674; 5,974,380; 6,487,535 & other U.S. and worldwide patents issued & pending. DTS, the Symbol, & DTS and the Symbol together are registered trademarks & DTS 2.0 Channel is a trademarks of DTS, Inc. Product includes software. © DTS, Inc. All Rights Reserved.

(Only available in TB300 series)



Manufactured under licence under U.S. Patent #'s: 5,451,942; 5,956,674; 5,974,380; 5,978,762; 6,487,535 & other U.S. and worldwide patents issued & pending. DTS and the Symbol are registered trademarks. & DTS 2.0+ Digital Out and the DTS logos are trademarks of DTS, Inc. Product Includes software. © DTS, Inc. All Rights Reserved.

(Only available in TB350 series)

HDMI

Open source licence notice

In the case of using open source software, Open Source licence are available on the product menu. Open Source Licence Notice is written only English.

WEEE



Correct Disposal of This Product (Waste Electrical & Electronic Equipment)

(Applicable in the European Union and other European countries with separate collection systems)

This marking on the product, accessories or literature indicates that the product and its electronic accessories (e.g. charger, headset, USB cable) should not be disposed of with other household waste at the end of their working life. To prevent possible harm to the environment or human health from uncontrolled waste disposal, please separate these items from other types of waste and recycle them responsibly to promote the sustainable reuse of material resources. Household users should contact either the retailer where they purchased this product, or their local government office, for details of where and how they can take these items for environmentally safe recycling. Business users should contact their supplier and check the terms and conditions of the purchase contract. This product and its electronic accessories should not be mixed with other commercial wastes for disposal.



Correct disposal of batteries in this product

(Applicable in the European Union and other European countries with separate battery return systems.)

This marking on the battery, manual or packaging indicates that the batteries in this product should not be disposed of with other household waste at the end of their working life. Where marked, the chemical symbols Hg, Cd or Pb indicate that the battery contains mercury, cadmium or lead above the reference levels in EC Directive 2006/66. If batteries are not properly disposed of, these substances can cause harm to human health or the environment. To protect natural resources and to promote material reuse, please separate batteries from other types of waste and recycle them through your local, free battery return system.

Other Information

Specifications

Environmental considerations	Operating	Temperature : 50°F ~ 104°F (10°C ~ 40°C) Humidity : 10 % ~ 80 %, non-condensing
	Storage	Temperature : -4°F ~ 113°F (-20°C ~ 45°C) Humidity : 5 % ~ 95 %, non-condensing
Tilt	-1°(±2°) ~ 20°(±2°)	
LED display System	Analogue: B/G, D/K, L, I (Depending on your country selection) Digital: DVB-T/DVB-C	
Colour/Video System	Analogue: PAL, SECAM, NTSC-4.43, NTSC-3.58, PAL60 Digital: MPEG-2 MP@ML, MPEG-4, H.264/AVC MP@L3, MP@L4.0, HP@L4.0	
Sound System	BG, DK, L, NICAM, MPEG1, DD, DD+, HEAAC	
HDMI IN	Video: 1080 24p, 1080p, 1080i, 720p, 576p, 480p Audio: 2Ch Linear PCM 32/44.1/48kHz, 16/20/24bits.	

Model Name	T19B300	T22B300	T24B300	T27B300	
Screen Size (Diagonal)	18.5 inches (47 cm)	21.5 inches (55 cm)	23.6 inches (60 cm)	27 inches (69 cm)	
Display Resolution	1366 x 768 @ 60Hz	1920 x 1080 @ 60Hz			
Sound (Output)	5W x 2				
Dimensions (WxDxH)	(Without Stand)	444.7 x 48.5 x 278.2 mm (17.5 x 1.9 x 11.0 inches)	509.7 x 47 x 318.2 mm (20.1 x 1.9 x 12.5 inches)	569.2 x 49 x 349.4 mm (22.4 x 1.9 x 13.8 inches)	643.3 x 49 x 397.9 mm (25.3 x 1.9 x 15.7 inches)
	(With Stand)	444.7 x 187 x 356.4 mm (17.5 x 7.4 x 14.0 inches)	509.7 x 195 x 396.6 mm (20.1 x 7.7 x 15.6 inches)	569.2 x 195 x 428 mm (22.4 x 7.7 x 16.9 inches)	643.3 x 252 x 476.5 mm (25.3 x 9.9 x 18.8 inches)
Weight	(Without Stand)	2.95 kg (6.5 lbs)	3.7 kg (8.2 lbs)	4.25 kg (9.4 lbs)	5.1 kg (11.2 lbs)
	(With Stand)	3.2 kg (7.1 lbs)	3.95 kg (8.7 lbs)	4.5 kg (9.9 lbs)	5.6 kg (12.3 lbs)

Model Name	T22B350	T23B350	T24B350	
Screen Size (Diagonal)	21.5 inches (55 cm)	23 inches (58 cm)	24 inches (61 cm)	
Display Resolution	1920 x 1080 @ 60Hz			
Sound (Output)	5W x 2			
Dimensions (WxDxH)	(Without Stand)	509.7 x 47 x 318.2 mm (20.1 x 1.9 x 12.5 inches)	547.5 x 49 x 337.9 mm (21.6 x 1.9 x 13.3 inches)	569.2 x 49 x 349.4 mm (22.4 x 1.9 x 13.8 inches)
	(With Stand)	509.7 x 195 x 396.6 mm (20.1 x 7.7 x 15.6 inches)	547.5 x 195 x 416.1 mm (21.6 x 7.7 x 16.4 inches)	569.2 x 195 x 428 mm (22.4 x 7.7 x 16.9 inches)
Weight	(Without Stand)	3.7 kg (8.2 lbs)	3.25 kg (7.2 lbs)	4.15 kg (9.1 lbs)
	(With Stand)	3.95 kg (8.7 lbs)	3.5 kg (7.7 lbs)	4.45 kg (9.8 lbs)

NOTE

- Design and specifications are subject to change without prior notice.
- For information about power supply, and more about power consumption, refer to the label attached to the product.
- Some models may not be available for purchase depending on the region.
- If there is no power cut-off switch, the power consumption is "0" only when the power cord is disconnected.
- DPM(Display Power Management) Function does not work if you used in conjunction with the HDMI IN (DVI) port of this product.



Contact SAMSUNG WORLDWIDE

If you have any questions or comments relating to Samsung products, please contact the SAMSUNG customer care centre.

Pais	☎ del Centro de atención al cliente	Sitio web
EUROPE		
ALBANIA	42 27 5755	http://www.samsung.com
AUSTRIA	0810 - SAMSUNG (7267864, € 0.07/min)	http://www.samsung.com
BELGIUM	02-201-24-18	http://www.samsung.com/be (Dutch) http://www.samsung.com/be_fr (French)
BOSNIA	05 133 1999	http://www.samsung.com
BULGARIA	07001 33 11	http://www.samsung.com
CROATIA	062 SAMSUNG (062 726 7864)	http://www.samsung.com
CZECH	800 - SAMSUNG (800-726786)	http://www.samsung.com
DENMARK	70 70 19 70	http://www.samsung.com
FINLAND	030 - 6227 515	http://www.samsung.com
FRANCE	01 48 63 00 00	http://www.samsung.com
GERMANY	01805 - SAMSUNG (726-7864, € 0,14/Min)	http://www.samsung.com
CYPRUS	From landline : 8009 4000	http://www.samsung.com
GREECE	From landline : 80111-SAMSUNG (7267864) From landline & mobile : (+30)210 6897691	http://www.samsung.com
HUNGARY	06-80-SAMSUNG (726-7864)	http://www.samsung.com
ITALIA	800-SAMSUNG (726-7864)	http://www.samsung.com
KOSOVO	+381 0113216899	http://www.samsung.com
LUXEMBURG	261 03 710	http://www.samsung.com
MACEDONIA	023 207 777	http://www.samsung.com
MONTENEGRO	020 405 888	http://www.samsung.com
NETHERLANDS	0900-SAMSUNG (0900-7267864) (€ 0,10/Min)	http://www.samsung.com
NORWAY	815-56 480	http://www.samsung.com
POLAND	0 801-1SAMSUNG (172-678) +48 22 607-93-33	http://www.samsung.com
PORTUGAL	80820-SAMSUNG (808207267)	http://www.samsung.com
RUMANIA	From landline : 08010-SAMSUNG (7267864) From landline & mobile : (+40)21 206 01 10	http://www.samsung.com
SERBIA	0700 SAMSUNG (0700 726 7864)	http://www.samsung.com
SLOVAKIA	0800 - SAMSUNG (0800-726 786)	www.samsung.com/sk
SPAIN	902 - 1 - SAMSUNG (902 172 678)	http://www.samsung.com
SWEDEN	0771 726 7864 (SAMSUNG)	http://www.samsung.com
SWITZERLAND	0848 - SAMSUNG (7267864, CHF 0.08/min)	http://www.samsung.com/ch http://www.samsung.com/ch_fr (French)
U.K	0330 SAMSUNG (7267864)	http://www.samsung.com
EIRE	0818 717100	http://www.samsung.com
LITHUANIA	8-800-77777	http://www.samsung.com
LATVIA	8000-7267	http://www.samsung.com
ESTONIA	800-7267	http://www.samsung.com
TURKEY	444 77 11	http://www.samsung.com
CIS		
RUSSIA	8-800-555-55-55	http://www.samsung.com
GEORGIA	8-800-555-555	http://www.samsung.com
ARMENIA	0-800-05-555	http://www.samsung.com
AZERBAIJAN	088-55-55-555	http://www.samsung.com
KAZAKHSTAN	8-10-800-500-55-500(GSM: 7799)	http://www.samsung.com
UZBEKISTAN	8-10-800-500-55-500	http://www.samsung.com
KYRGYZSTAN	00-800-500-55-500	http://www.samsung.com
TADJIKISTAN	8-10-800-500-55-500	http://www.samsung.com

Pais	☎ del Centro de atención al cliente	Sitio web
MONGOLIA		http://www.samsung.com
UKRAINE	0-800-502-000	http://www.samsung.com/ua http://www.samsung.com/ua_ru
BELARUS	810-800-500-55-500	http://www.samsung.com
MOLDOVA	00-800-500-55-500	http://www.samsung.com
ASIA PACIFIC		
AUSTRALIA	1300 362 603	http://www.samsung.com
NEW ZEALAND	0800 SAMSUNG (0800 726 786)	http://www.samsung.com
CHINA	400-810-5858	http://www.samsung.com
HONG KONG	(852) 3698 - 4698	http://www.samsung.com/hk http://www.samsung.com/hk_en/
INDIA	1800 1100 11 3030 8282 1800 3000 8282 1800 266 8282	http://www.samsung.com
INDONESIA	0800-112-8888 021-5699-7777	http://www.samsung.com
JAPAN	0120-327-527	http://www.samsung.com
MALAYSIA	1800-88-9999	http://www.samsung.com
PHILIPPINES	1-800-10-SAMSUNG (726-7864) for PLDT 1-800-3-SAMSUNG(726-7864) for Digitel 1-800-8-SAMSUNG(726-7864) for Globe02-5805777	http://www.samsung.com
SINGAPORE	1800-SAMSUNG (726-7864)	http://www.samsung.com
THAILAND	1800-29-3232 02-689-3232	http://www.samsung.com
TAIWAN	0800-329-999 0266-026-066	http://www.samsung.com
VIETNAM	1 800 588 889	http://www.samsung.com
MIDDLE EAST		
IRAN	021-8255	http://www.samsung.com
OMAN	800-SAMSUNG(726-7864)	http://www.samsung.com
KUWAIT	183-2255	http://www.samsung.com
BAHRAIN	8000-4726	http://www.samsung.com
EGYPT	08000-726786	http://www.samsung.com
JORDAN	800-22273	http://www.samsung.com
MOROCCO	080 100 2255	http://www.samsung.com
SAUDI ARABIA	9200-21230	http://www.samsung.com
U.A.E	800-SAMSUNG (726-7864)	http://www.samsung.com
AFRICA		
CAMEROON	7095- 0077	http://www.samsung.com
COTE D' IVOIRE	8000 0077	http://www.samsung.com
GHANA	0800-10077 0302-200077	http://www.samsung.com
KENYA	0800 724 000	http://www.samsung.com
NIGERIA	0800-726-7864	http://www.samsung.com
SENEGAL	800-00-0077	http://www.samsung.com
SOUTH AFRICA	0860-SAMSUNG(726-7864)	http://www.samsung.com
TANZANIA	0685 88 99 00	http://www.samsung.com
UGANDA	0800 300 300	http://www.samsung.com